

- **Phase-Lock Loop Clock Driver for Synchronous DRAM and General-Purpose Applications**
- **Spread Spectrum Clock Compatible**
- **Operating Frequency: 24 MHz to 200 MHz**
- **Low Jitter (Cycle-cycle): <|150 ps| Over the Range 66 MHz–200 MHz**
- **Distributes One Clock Input to One Bank of Five Outputs (CLKOUT Is Used to Tune the Input-Output Delay)**
- **Three-States Outputs When There Is no Input Clock**
- **Operates From Single 3.3-V Supply**
- **Available in 8-Pin TSSOP and 8-Pin SOIC Packages**
- **Consumes Less Than 100- μ A (Typically) in Power Down Mode**
- **Internal Feedback Loop Is Used to Synchronize the Outputs to the Input Clock**
- **25- Ω On-Chip Series Damping Resistors**
- **Integrated RC PLL Loop Filter Eliminates the Need for External Components**

D OR PW PACKAGE
(TOP VIEW)

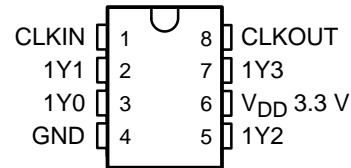

description

The CDCVF2505 is a high-performance, low-skew, low-jitter, phase-lock loop (PLL) clock driver. It uses a PLL to precisely align, in both frequency and phase, the output clocks (1Y[0–3] and CLKOUT) to the input clock signal (CLKIN). The CDCVF2505 operates at 3.3 V. It also provides integrated series-damping resistors that make it ideal for driving point-to-point loads.

One bank of five outputs provides low-skew, low-jitter copies of CLKIN. Output duty cycles are adjusted to 50 percent, independent of duty cycle at CLKIN. The device automatically goes in power-down mode when no input signal is applied to CLKIN.

Unlike many products containing PLLs, the CDCVF2505 does not require an external RC network. The loop filter for the PLLs is included on-chip, minimizing component count, space, and cost.

Because it is based on the PLL circuitry, the CDCVF2505 requires a stabilization time to achieve phase lock of the feedback signal to the reference signal. This stabilization is required following power up and application of a fixed-frequency, fixed-phase signal at CLKIN, and following any changes to the PLL reference.

The CDCVF2505 is characterized for operation from –40°C to 85°C.



Please be aware that an important notice concerning availability, standard warranty, and use in critical applications of Texas Instruments semiconductor products and disclaimers thereto appears at the end of this data sheet.

PRODUCTION DATA information is current as of publication date. Products conform to specifications per the terms of Texas Instruments standard warranty. Production processing does not necessarily include testing of all parameters.

**TEXAS
INSTRUMENTS**

POST OFFICE BOX 655303 • DALLAS, TEXAS 75265

Copyright © 2001, Texas Instruments Incorporated

CDCVF2505

3.3-V CLOCK PHASE-LOCK LOOP CLOCK DRIVER

SCAS640A – MAY 2001

FUNCTION TABLE

INPUT	OUTPUTS	
	1Y (0:3)	CLKOUT
L	L	L
H	H	H
<10 MHz†	Z	Z

† Typically, below 2 MHz the device goes in power-down mode in which the PLL is turned off and the outputs enter into Hi-Z mode. If a >10 MHz signal is applied at CLKIN the PLL turns on, reacquires lock and stabilizes after approximately 100 μs. The outputs will then be enabled.

functional block diagram

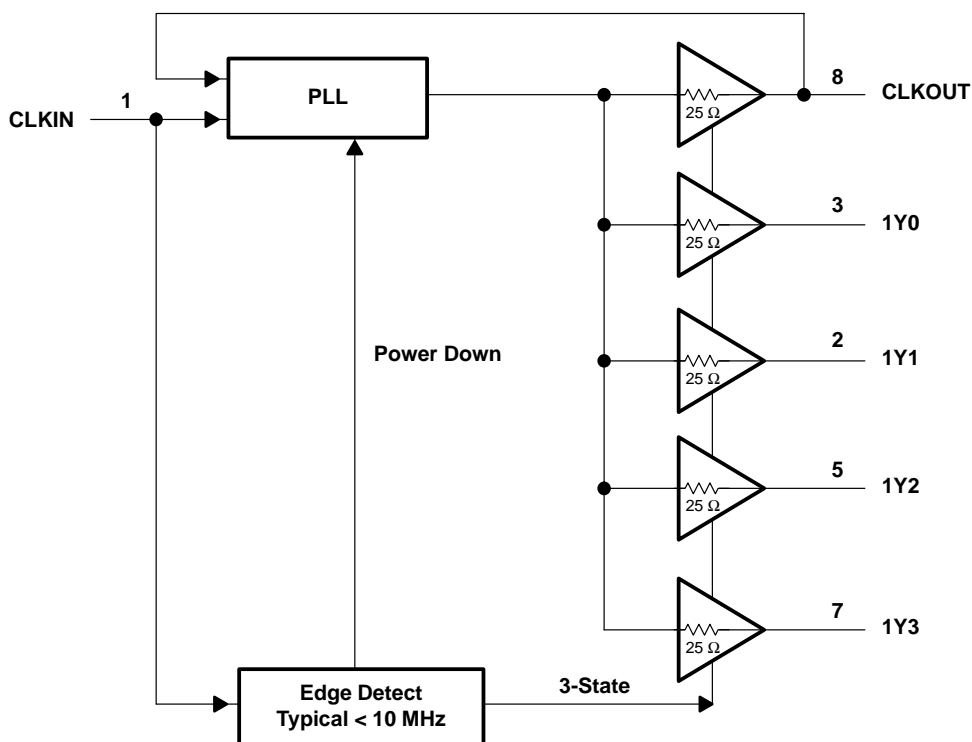

Terminal Functions

TERMINAL NAME	NO.	I/O	DESCRIPTION
1Y[0–3]	2, 3, 5, 7	O	Clock outputs. These outputs are low-skew copies of CLKIN. Each output has an integrated 25- Ω series damping resistor.
CLKIN	1	I	Clock input. CLKIN provides the clock signal to be distributed by the CDCVF2505 clock driver. CLKIN is used to provide the reference signal to the integrated PLL that generates the clock output signals. CLKIN must have a fixed frequency and fixed phase for the PLL to obtain phase lock. Once the circuit is powered up and a valid signal is applied, a stabilization time (100 μ s) is required for the PLL to phase lock the feedback signal to CLKIN.
CLKOUT	8	O	Feedback output. CLKOUT completes the internal feedback loop of the PLL. This connection is made inside the chip and an external feedback loop should NOT be connected. CLKOUT can be loaded with a capacitor to achieve zero delay between CLKIN and the Y outputs.
GND	4	Power	Ground
V _{DD} 3.3V	6	Power	3.3-V Supply

absolute maximum ratings over operating free-air temperature (unless otherwise noted)†

Supply voltage range, V _{DD}	–0.5 V to 4.3 V
Input voltage range, V _I (see Notes 1 and 2)	–0.5 V to V _{DD} + 0.5 V
Output voltage range, V _O (see Notes 1 and 2)	–0.5 V to V _{DD} + 0.5 V
Input clamp current, I _{IK} (V _I < 0 or V _I > V _{DD})	±50 mA
Output clamp current, I _{OK} (V _O < 0 or V _O > V _{DD})	±50 mA
Continuous total output current, I _O (V _O = 0 to V _{DD})	±50 mA
Package thermal impedance, θ_{JA} (see Note 3): D package	165.5°C/W
PWR package	230.5°C/W
Storage temperature range, T _{stg}	–65°C to 150°C

† Stresses beyond those listed under “absolute maximum ratings” may cause permanent damage to the device. These are stress ratings only, and functional operation of the device at these or any other conditions beyond those indicated under “recommended operating conditions” is not implied. Exposure to absolute-maximum-rated conditions for extended periods may affect device reliability.

- NOTES: 1. The input and output negative-voltage ratings may be exceeded if the input and output clamp-current ratings are observed.
 2. This value is limited to 4.3 V maximum.
 3. The package thermal impedance is calculated in accordance with JESD 51.

recommended operating conditions

	MIN	NOM	MAX	UNIT
Supply voltage, V _{DD}	3	3.3	3.6	V
High-level input voltage, V _{IH}	2			V
Low-level input voltage, V _{IL}			0.8	V
Input voltage, V _I	0		V _{DD}	V
High-level output current, I _{OH}			–12	mA
Low-level output current, I _{OL}			12	mA
Operating free-air temperature, T _A	–40		85	°C

CDCVF2505

3.3-V CLOCK PHASE-LOCK LOOP CLOCK DRIVER

SCAS640A – MAY 2001

timing requirements over recommended ranges of supply voltage and operating free-air temperature

	MIN	NOM	MAX	UNIT
f_{clk} Clock frequency	24		200	MHz
Input clock duty cycle	40%	50%	60%	
Stabilization time (see Note 4)			100	μ s

NOTE 4: Time required for the integrated PLL circuit to obtain phase lock of its feedback signal to its reference signal. For phase lock to be obtained, a fixed-frequency, fixed-phase reference signal must be present at CLKIN. Until phase lock is obtained, the specifications for propagation delay, skew, and jitter parameters given in the switching characteristics table are not applicable. This parameter does not apply for input modulation under SSC application.

electrical characteristics over recommended operating free-air temperature range (unless otherwise noted)

PARAMETER		TEST CONDITIONS	V_{DD}	MIN	TYP [†]	MAX	UNIT
V_{IK}	Input voltage	$I_I = -18$ mA	3 V			-1.2	V
V_{OH}	High-level output voltage	$I_{OH} = -100$ μ A	MIN to MAX	$V_{DD}-0.2$			V
		$I_{OH} = -12$ mA	3 V	2.1			
		$I_{OH} = -6$ mA	3 V	2.4			
V_{OL}	Low-level output voltage	$I_{OL} = 100$ μ A	MIN to MAX			0.2	V
		$I_{OL} = 12$ mA	3 V			0.8	
		$I_{OL} = 6$ mA	3 V			0.55	
I_{OH}	High-level output current	$V_O = 1$ V	3 V			-27	
		$V_O = 1.65$ V	3.3 V			-36	
I_{OL}	Low-level output current	$V_O = 2$ V	3 V			27	
		$V_O = 1.65$ V	3.3 V			40	
I_I	Input current	$V_I = 0$ V or V_{DD}				± 5	μ A
C_i	Input capacitance	$V_I = 0$ V or V_{DD}	3.3 V			4.2	pF
C_o	Output capacitance	Y_n	$V_I = 0$ V or V_{DD}	3.3 V		2.8	pF
		CLKOUT				5.2	

[†] All typical values are at respective nominal V_{DD} and 25°C.

switching characteristics over recommended ranges of supply voltage and operating free-air temperature, $C_L = 25$ pF, $V_{DD} = 3.3$ V \pm 0.3 V (see Note 5)

PARAMETER		TEST CONDITIONS	MIN	TYP [†]	MAX	UNIT
t_{pd}	Propagation delay (normalized (see Figure 3))	CLKIN to Y_n , $f = 66$ MHz to 200 MHz	-150		150	ps
$t_{sk(o)}$	Output skew (see Note 6)	Y_n to Y_n			150	ps
$t_{c(jit_cc)}$	Jitter (cycle to cycle) (see Figure 5)	$f = 66$ MHz to 200 MHz		70	150	ps
		$f = 24$ MHz to 50 MHz		200	400	
odc	Output duty cycle (see Figure 4)	$f = 24$ MHz to 200 MHz at 50% V_{DD}	45%		55%	
t_r	Rise time	$V_O = 0.4$ V to 2 V	0.5		2.0	ns
t_f	Fall time	$V_O = 2$ V to 0.4 V	0.5		2.0	ns

[†] All typical values are at respective nominal V_{DD} and 25°C.

NOTE 5: The $t_{sk(o)}$ specification is only valid for equal loading of all outputs.



TYPICAL CHARACTERISTICS

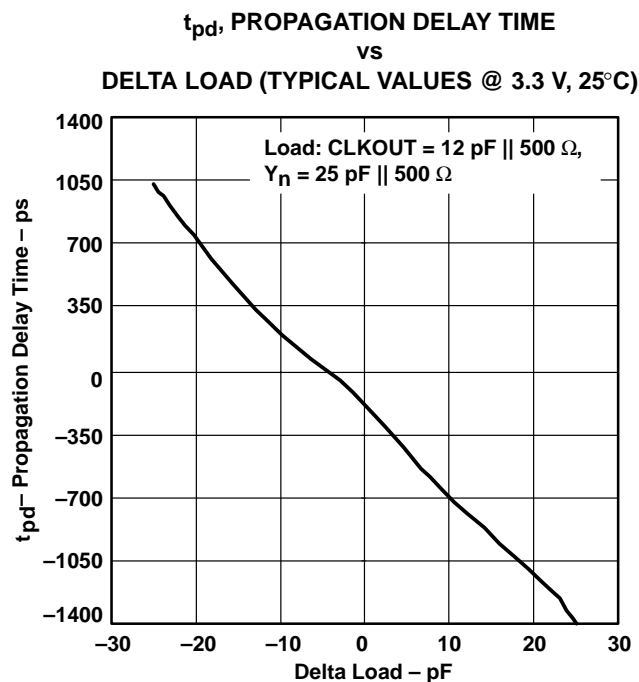

Figure 1

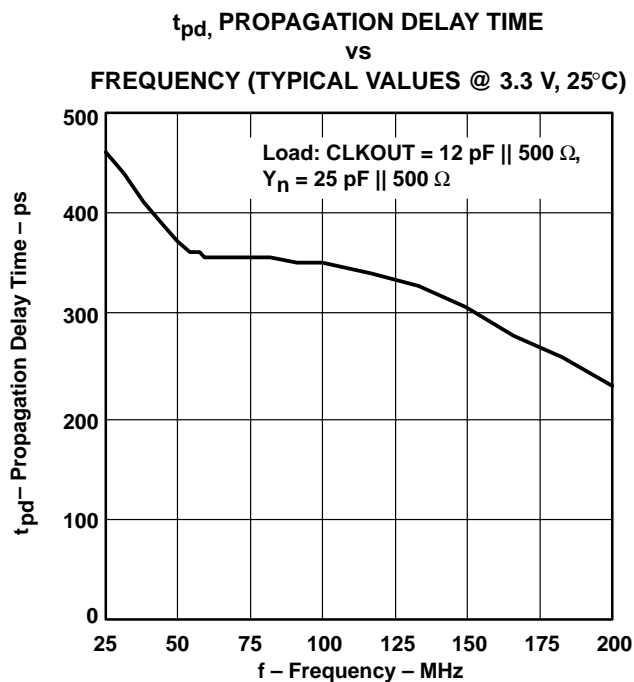

Figure 2

NOTE: Delta Load = CLKOUT Load – Yn Load

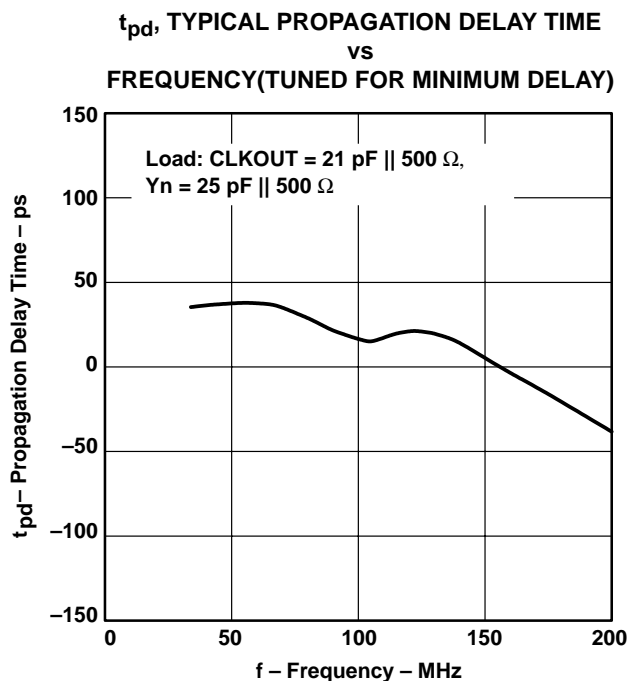

Figure 3

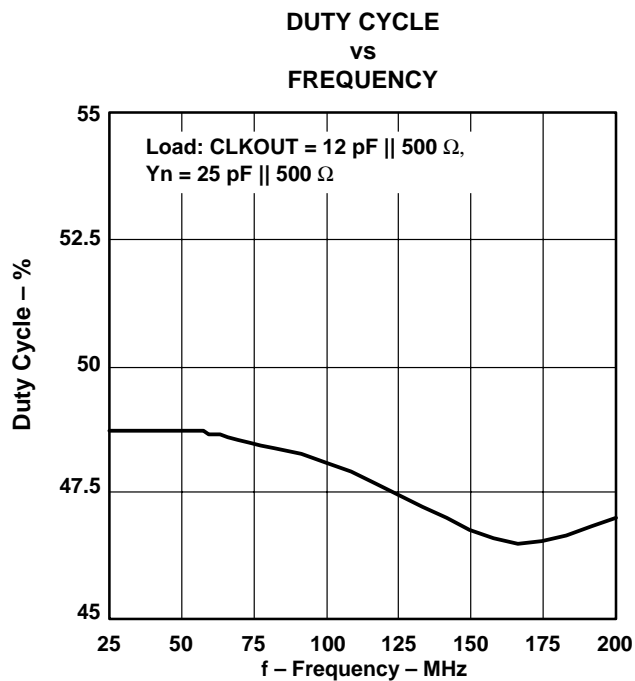

Figure 4

CDCVF2505 3.3-V CLOCK PHASE-LOCK LOOP CLOCK DRIVER

SCAS640A – MAY 2001

TYPICAL CHARACTERISTICS

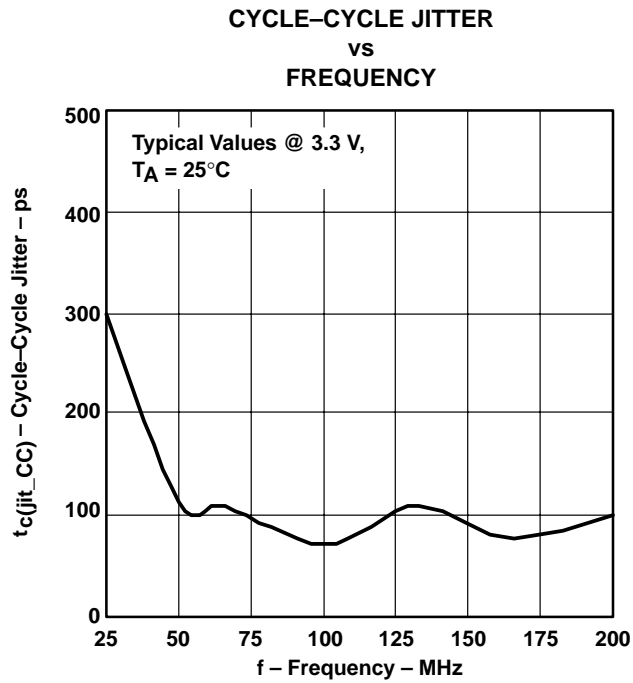

Figure 5

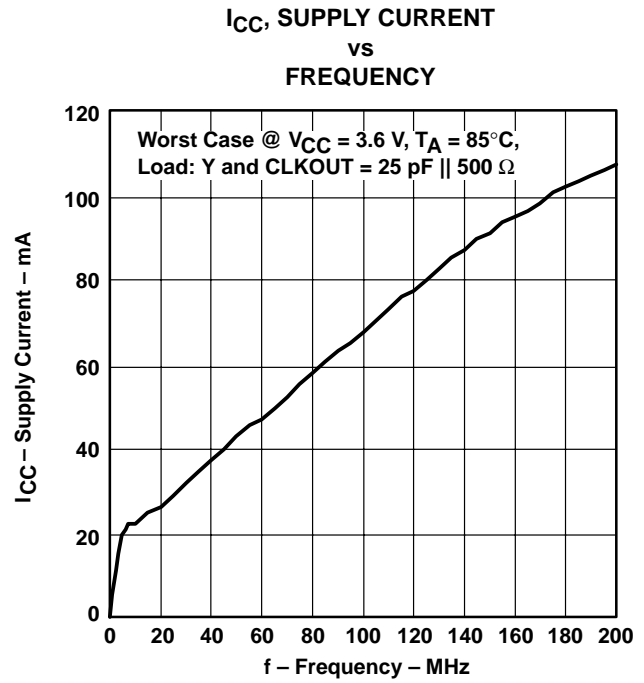

Figure 6

PARAMETER MEASUREMENT INFORMATION

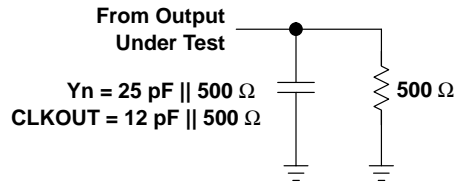

Figure 7. Test Load Circuit

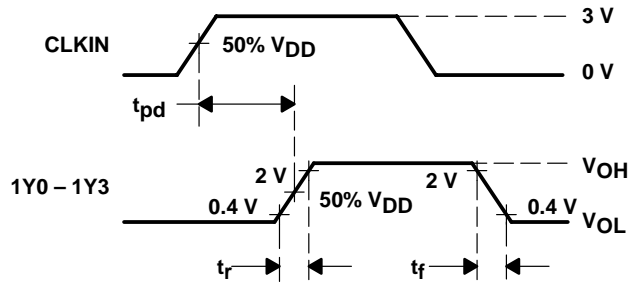

Figure 8. Voltage Threshold for Measurements, Propagation Delay (t_{pd})

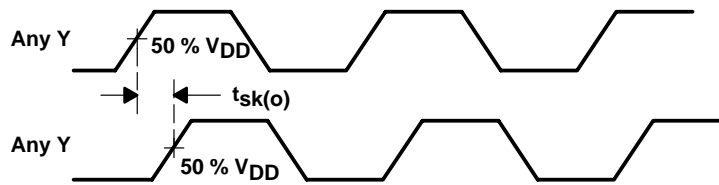

Figure 9. Output Skew

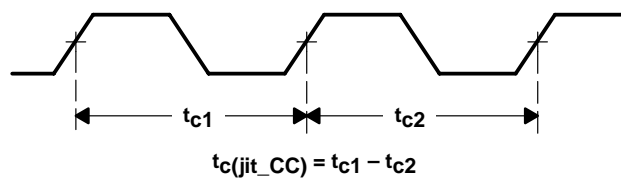

Figure 10. Cycle-to-Cycle Jitter

CDCVF2505 3.3-V CLOCK PHASE-LOCK LOOP CLOCK DRIVER

SCAS640A – MAY 2001

MECHANICAL DATA

D (R-PDSO-G**)

PLASTIC SMALL-OUTLINE PACKAGE

14 PINS SHOWN

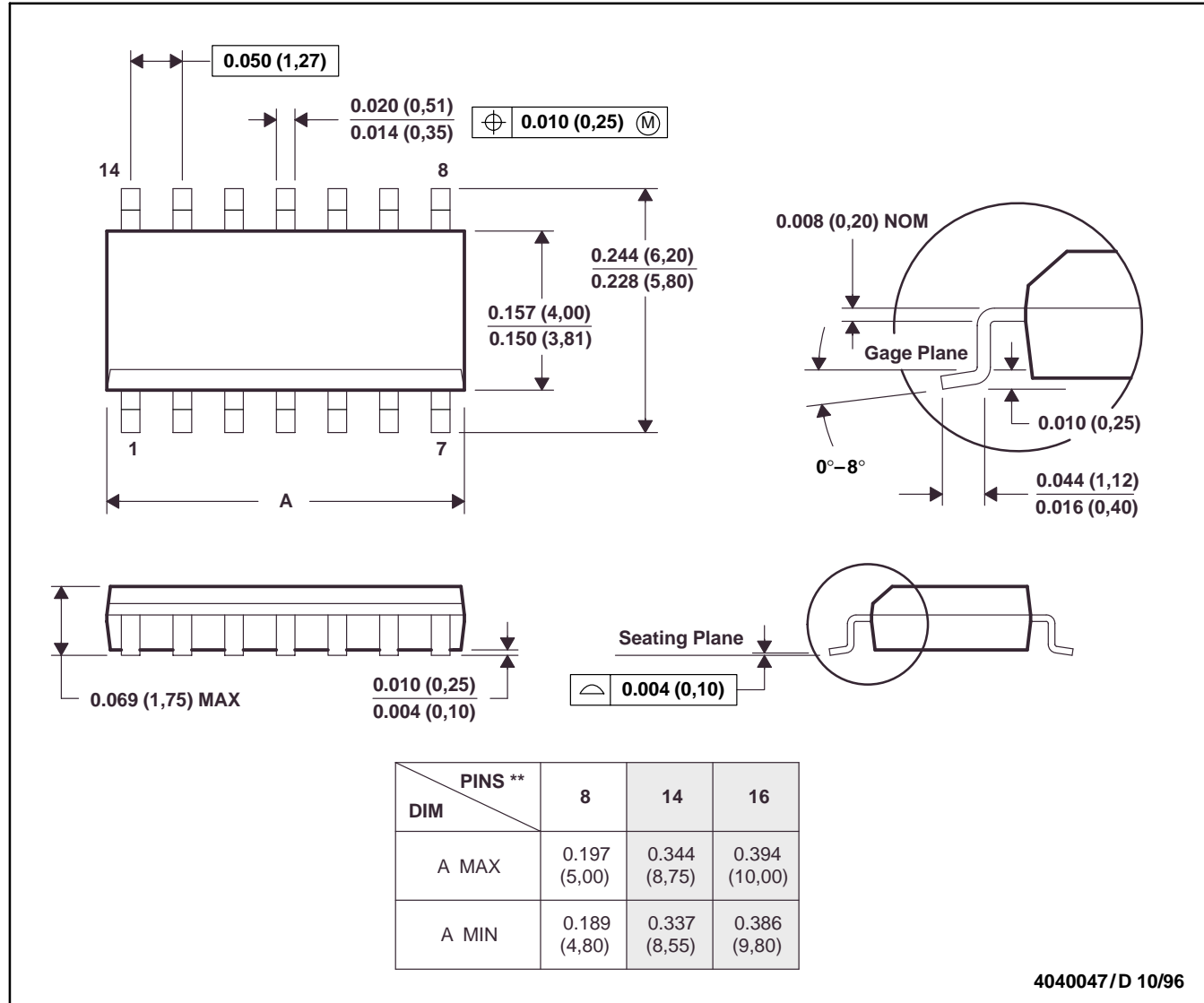

- NOTES: A. All linear dimensions are in inches (millimeters).
 B. This drawing is subject to change without notice.
 C. Body dimensions do not include mold flash or protrusion, not to exceed 0.006 (0,15).
 D. Falls within JEDEC MS-012

MECHANICAL DATA

PW (R-PDSO-G)**

PLASTIC SMALL-OUTLINE PACKAGE

14 PINS SHOWN

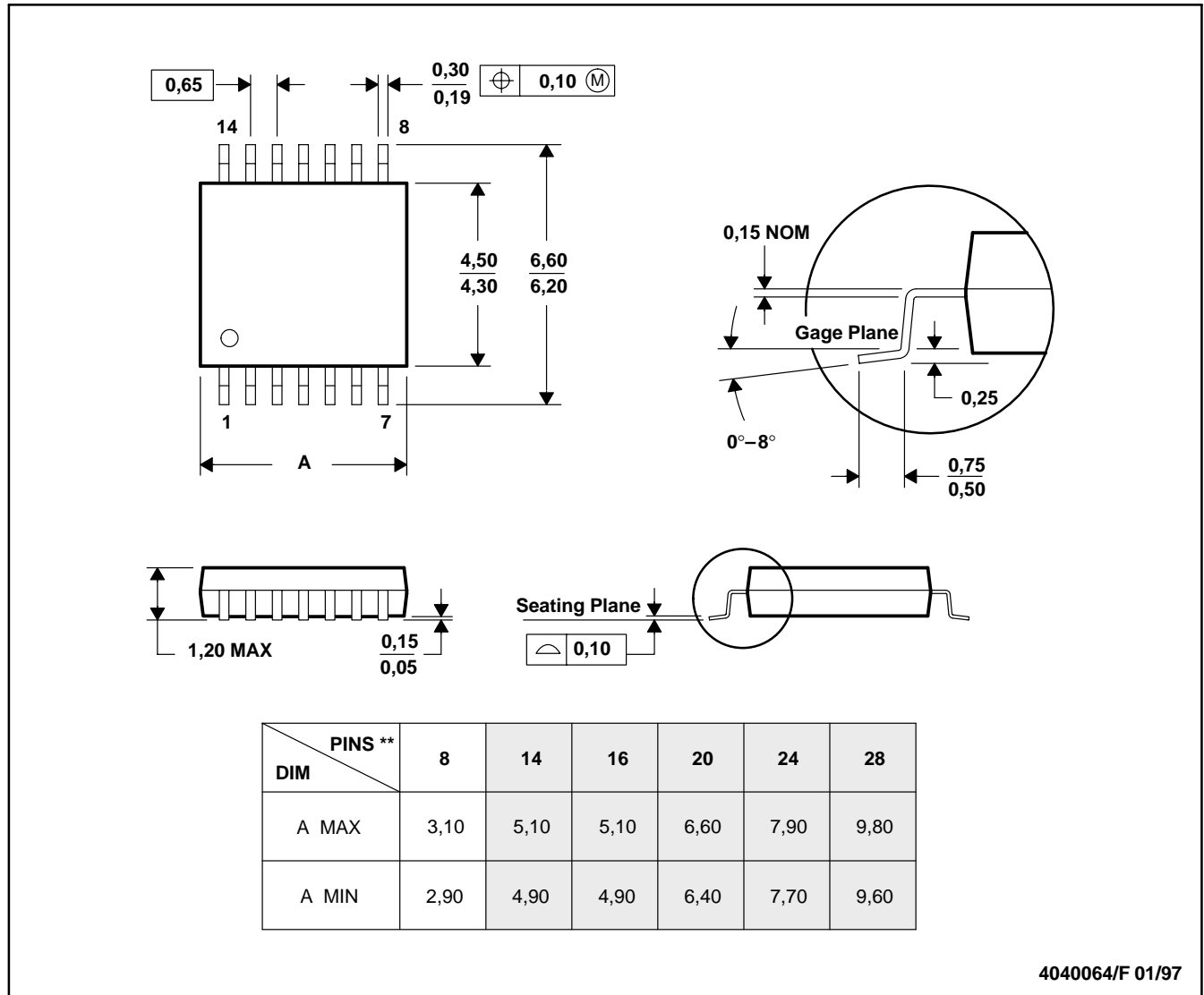

- NOTES: A. All linear dimensions are in millimeters.
 B. This drawing is subject to change without notice.
 C. Body dimensions do not include mold flash or protrusion not to exceed 0,15.
 D. Falls within JEDEC MO-153

IMPORTANT NOTICE

Texas Instruments and its subsidiaries (TI) reserve the right to make changes to their products or to discontinue any product or service without notice, and advise customers to obtain the latest version of relevant information to verify, before placing orders, that information being relied on is current and complete. All products are sold subject to the terms and conditions of sale supplied at the time of order acknowledgment, including those pertaining to warranty, patent infringement, and limitation of liability.

TI warrants performance of its products to the specifications applicable at the time of sale in accordance with TI's standard warranty. Testing and other quality control techniques are utilized to the extent TI deems necessary to support this warranty. Specific testing of all parameters of each device is not necessarily performed, except those mandated by government requirements.

Customers are responsible for their applications using TI components.

In order to minimize risks associated with the customer's applications, adequate design and operating safeguards must be provided by the customer to minimize inherent or procedural hazards.

TI assumes no liability for applications assistance or customer product design. TI does not warrant or represent that any license, either express or implied, is granted under any patent right, copyright, mask work right, or other intellectual property right of TI covering or relating to any combination, machine, or process in which such products or services might be or are used. TI's publication of information regarding any third party's products or services does not constitute TI's approval, license, warranty or endorsement thereof.

Reproduction of information in TI data books or data sheets is permissible only if reproduction is without alteration and is accompanied by all associated warranties, conditions, limitations and notices. Representation or reproduction of this information with alteration voids all warranties provided for an associated TI product or service, is an unfair and deceptive business practice, and TI is not responsible nor liable for any such use.

Resale of TI's products or services with statements different from or beyond the parameters stated by TI for that product or service voids all express and any implied warranties for the associated TI product or service, is an unfair and deceptive business practice, and TI is not responsible nor liable for any such use.

Also see: [Standard Terms and Conditions of Sale for Semiconductor Products](http://www.ti.com/sc/docs/stdterms.htm). www.ti.com/sc/docs/stdterms.htm

Mailing Address:

Texas Instruments
Post Office Box 655303
Dallas, Texas 75265