

Features

- Wide Frequency Range: 20 MHz to 4 GHz, in 2 bands
- Surface Mount SP3T Switch in Compact Outline:
 - 8 mm L x 5 mm W x 2.5 mm H
- Higher Average Power Handling than Plastic Packaged
 - MMIC Switches: 100 W CW
- High RF Peak Power: 500 W
- Low Insertion Loss: 0.5 dB
- High IIP3: 65 dBm
- Faster Switching Speed: 1 μ s
- Operates From : 5 V & -180 V
- RoHS Compliant

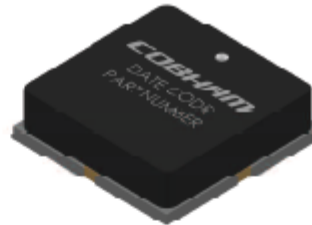

Case Style CS320

Applications

- High Power Transmit/Receive (TR) Switching
- Active Receiver Protection

Description

The MSW3200-320 and MSW3201-320 Surface Mount Silicon PIN Diode SP3T Switches are manufactured using Aeroflex/Metelics proven hybrid manufacturing process incorporating High Voltage PIN Diodes and passive devices integrated within a ceramic substrate. This low profile, compact, surface mount component, (8 mm L x 8 mm W x 2.5 mm H) offers superior low and high signal performance to comparable MMIC devices in QFN packages. The SP3T switches are designed in a symmetrical topology to optimize Insertion Loss and Isolation performance. Using PIN Diodes with lower thermal resistance (< 10 $^{\circ}$ C/W), RF C.W. incident power levels of + 50 dBm and RF peak incident power levels of + 57 dBm are very achievable in higher power cold and hot switching applications @ + 85 $^{\circ}$ C. The lower PIN Diode series resistance (< 1.0 Ω), coupled with the longer minority carrier lifetime, (> 4 μ s), provides better IIP3 distortion values > + 65 dBm .

These MSW3200-320 & MSW3201-320 SP3T Switches are designed to be used in higher power switch applications, operating from 20 MHz to 1,000 MHz, and 400-4,000 MHz respectively for high volume, surface mount, solder re-flow manufacturing useful in IED and Radar market segments. These products are durable, reliable, and capable of meeting all military, commercial, and industrial environments. The devices are fully RoHS compliant.

Environmental Capabilities

The MSW3200-320 & MSW3201-320 SP3T Switches are capable of meeting the environmental requirements of MIL-STD-202 and MIL-STD-750.

ESD and Moisture Sensitivity Level Rating

PIN Diode Switches are susceptible to ESD conditions as with all semiconductors. The ESD rating for this device is Class 1C, HBM. The moisture sensitivity level rating for this device is MSL 2.

Pin Out

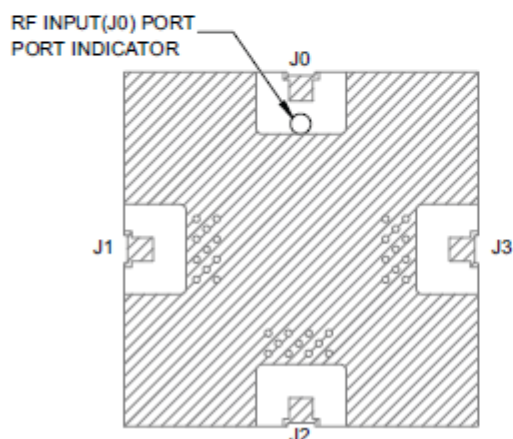

Schematic

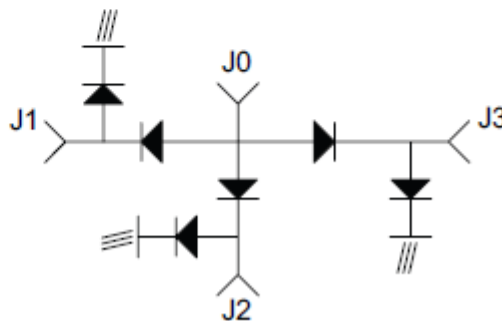

MSW3200-320 Electrical Specifications

$Z_0 = 50 \Omega$, $P_{1M} = 0 \text{ dBm}$, $T_A = 25 \text{ }^\circ\text{C}$ (Unless Otherwise Defined)

Parameter	Symbol	Test Conditions	Min. Value	Typ. Value	Max. Value	Units
Frequency	F		10	20-1000	1500	MHz
Insertion Loss	IL	Bias state 1: port J0 to J1 Bias state 2: port J0 to J2 Bias state 3: port J0 to J3	-	0.4	0.6	dB
Return Loss	RL	Bias state 1: port J0 to J1 Bias state 2: port J0 to J2 Bias state 3: port J0 to J3	18	20	-	dB
Isolation	Isol	Bias state 1: port J0 to J1 Bias state 2: port J0 to J2 Bias state 3: port J0 to J3	44	47	-	dB
CW Incident Power (Note 2)	$P_{inc}(CW)$	source & load VSWR = 1.5:1	-	50	-	dBm
Peak Incident Power (Note 2)	$P_{inc}(Pk)$	source & load VSWR = 1.5:1, pulse width = 10 μs , duty cycle = 1 %	-	57	-	dBm
Switching Time (Note 1)	t_{sw}	10% -90% RF voltage, TTL rep rate = 100 kHz	-	2	3	μs
Input 3rd Order Intercept Point	IIP3	$F_1 = 500 \text{ MHz}$, $F_2 = 510 \text{ MHz}$, $P_1 = P_2 = 40 \text{ dBm}$, measured on path biased to low loss state	60	65	-	dBm

MSW3201-320 Electrical Specifications

$Z_0 = 50 \Omega$, $P_{IN} = 0 \text{ dBm}$, $T_A = 25 \text{ }^\circ\text{C}$ (Unless Otherwise Defined)

Parameter	Symbol	Test Conditions	Min. Value	Typ. Value	Max. Value	Units
Frequency	F		200	400-4000	4500	MHz
Insertion Loss	IL	Bias state 1: port J0 to J1 Bias state 2: port J0 to J2 Bias state 3: port J0 to J3	-	0.6	0.8	dB
Return Loss	RL	Bias state 1: port J0 to J1 Bias state 2: port J0 to J2 Bias state 3: port J0 to J3	14	15	-	dB
Isolation	Isol	Bias state 1: port J0 to J2, J3 Bias state 2: port J0 to J1, J3 Bias state 3: port J0 to J1, J2	32	35	-	dB
CW Incident Power (Note 2)	$P_{inc}(CW)$	source & load VSWR = 1.5:1	-	50	-	dBm
Peak Incident Power (Note 2)	$P_{inc}(Pk)$	source & load VSWR = 1.5:1, pulse width = 10 μs , duty cycle = 1 %	-	57	-	dBm
Switching Time (Note 1)	t_{sw}	10% -90% RF voltage, TTL rep rate = 100 kHz	-	1	2	μs
Input 3rd Order Intercept Point	IIP3	$F_1 = 2.00 \text{ GHz}$, $F_2 = 2.01 \text{ GHz}$, $P_1 = P_2 = 10 \text{ dBm}$, measured on path biased to low loss state	60	65	-	dBm

Notes:

- Switching Speed (50 % TTL – 10/90 % RF Voltage) is a function of the PIN diode driver performance as well as the characteristics of the diode. An RC "current spiking network" is used on the driver output to provide a transient current to rapidly remove stored charge from the PIN diode. Typical component values are: R = 50 to 220 Ω and C = 470 to 1,000 pF. MACOMs MPD3T28125-700 is the recommended PIN diode driver to interface with the MSW3200-320, MSW3201-320 SP3T switches. Its data sheet may be found at
- PIN diode DC reverse voltage to maintain high resistance in the OFF PIN diode is determined by RF frequency, incident power, and VSWR as well as by the characteristics of the diode. The minimum reverse bias voltage values are provided in this datasheet. The input signal level applied for small signal testing is approximately 0 dBm.

RF Bias Network Component Values

P/N	F (MHz)	DC Blocking Capacitors	Inductors	RF Bypass Capacitors
MSW3200-320	50 – 1,000	0.1 μ F	4.7 μ H	0.1 μ F
MSW3201-320	400 – 4,000	27 pF	82 nH	270 pF

Minimum Reverse Bias Voltage at TX, RX, DC Ports vs. Signal Frequency

$P_{INC} = 100$ W CW, $Z_0 = 50\Omega$ with 1.5:1 VSWR

Part Number	F = 20 MHz	F = 100 MHz	F = 200 MHz	F = 400 MHz	F = 1 GHz	F = 4 GHz
MSW3200-320	-180 V	-150 V	-115 V	-85 V	-35 V	NA
MSW3201-320	NA	NA	-150 V	-115 V	-55 V	-35 V

Note: "NA" denotes the switch is not recommended for use in that frequency band.

Absolute Maximum Ratings

$Z_0 = 50 \Omega$, $T_A = +25 \text{ }^\circ\text{C}$ (Unless Otherwise Defined)

Parameter	Conditions	Absolute Maximum Value
Forward Current - J1, J2, J3 Port		250 mA
Reverse Voltage - J1, J2, J3 Port		300 V
Forward Diode Voltage	$I_f = 250$ mA	1.2 V
Operating Temperature		-65 $^\circ$ C to 125 $^\circ$ C
Storage Temperature		-65 $^\circ$ C to 150 $^\circ$ C
Junction Temperature		175 $^\circ$ C
Assembly Temperature		260 $^\circ$ C for 10 s
CW Incident Power Handling – J0 or J1, J2, J3 Port (Note)	Source & load VSWR = 1.5 :1, $T_{case} = 85 \text{ }^\circ\text{C}$, cold switching	50 dBm
Peak Incident Power Handling – J0 or J1, J2, J3 Port (Note 1)	Source & load VSWR = 1.5 :1, $T_{case} = 85 \text{ }^\circ\text{C}$, cold switching, pulse width = 10 μ s, duty cycle = 1 %	57 dBm
Total Dissipated RF & DC Power (Note 1)	$T_{case} = 85 \text{ }^\circ\text{C}$, cold switching	12 W

Notes:

- Backside RF and DC grounding area of device must be completely solder-attached to RF circuit board vias for proper electrical and thermal circuit grounding.

MSW3200-320 Small Signal Typical Performance

$Z_0 = 50 \Omega$, $T_A = +25 \text{ }^\circ\text{C}$ (Unless Otherwise Defined)

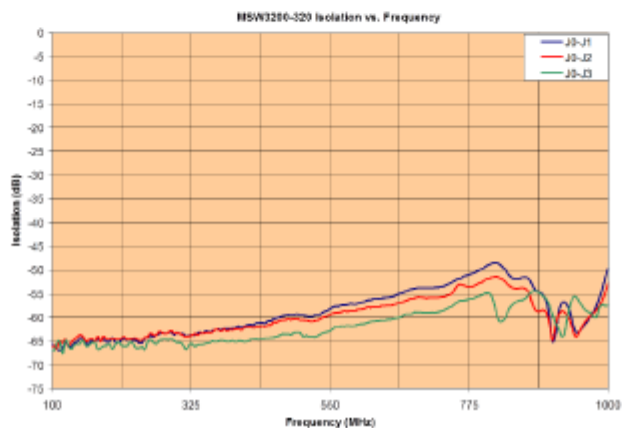
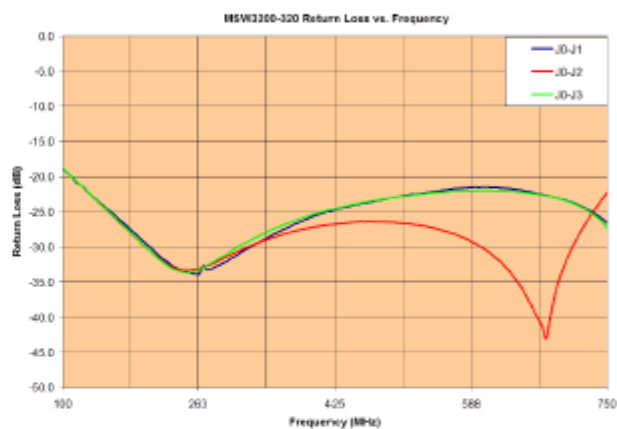
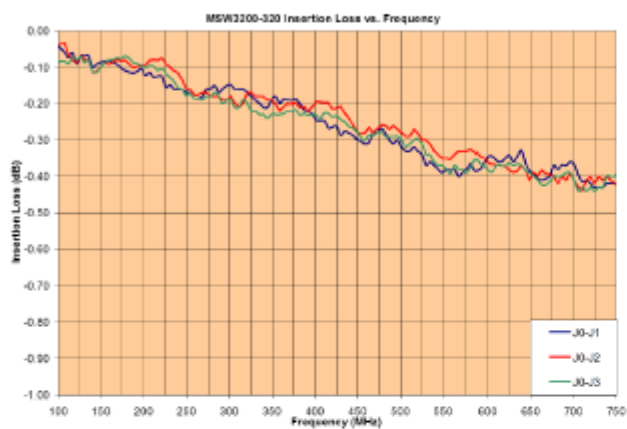

MSW3201-320 Small Signal Typical Performance

$Z_0 = 50 \Omega$, $T_A = +25 \text{ }^\circ\text{C}$ (Unless Otherwise Defined)

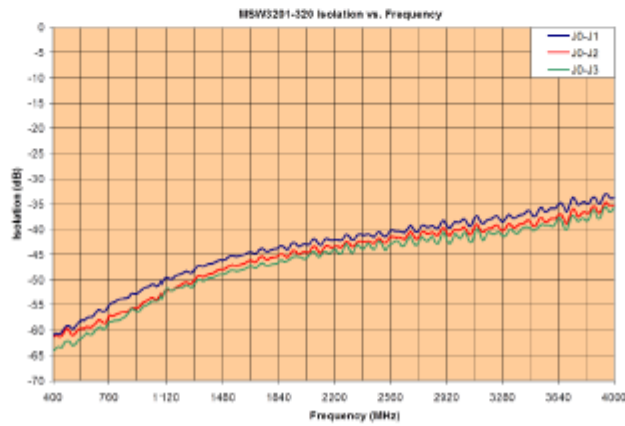
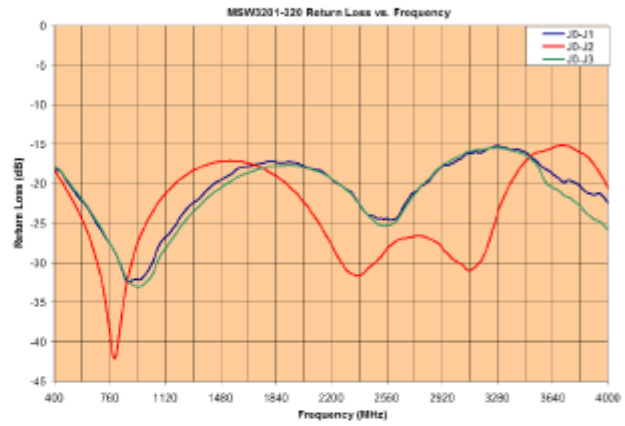
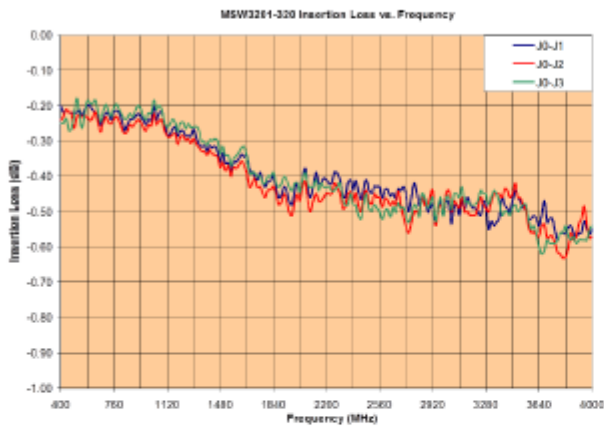

SP3T Switch Evaluation Board Layout

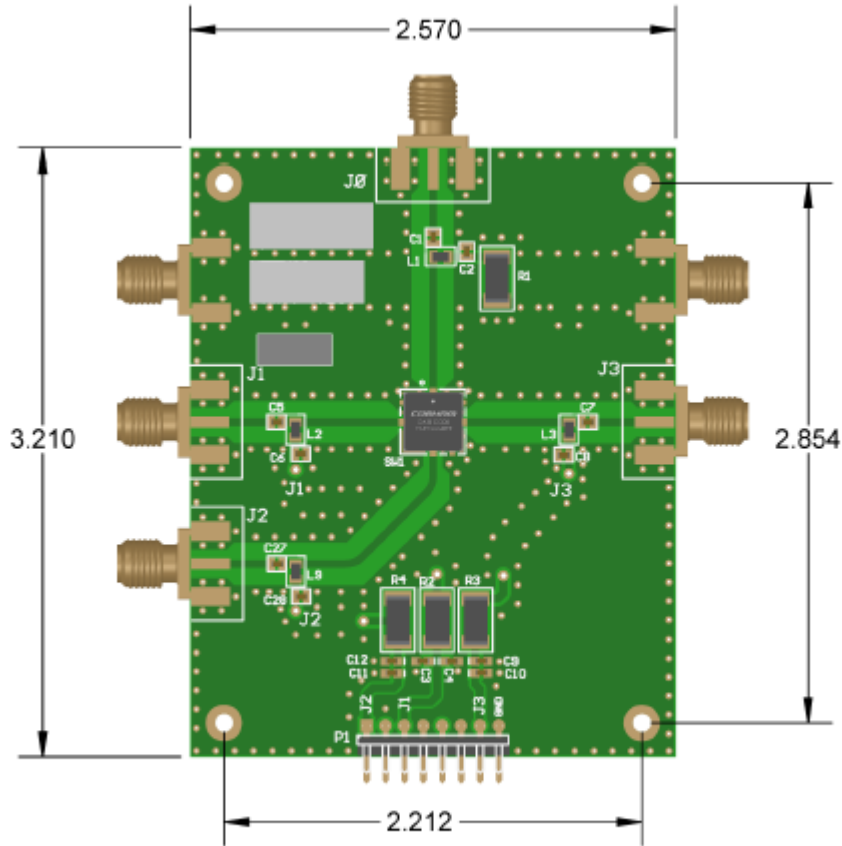

APPLIES TO THE FOLLOWING EVAL BOARDS:
 CS320 - BAND 1 / BAND 2 / BAND 3

MSW3200-320 Band 1 Evaluation Board BOM

Item	DC Blocking Caps	RF Bypass Caps	Second Bypass Cap (Optional)	Inductor	Resistor	Resistor	Header Pin	SMA Connector
Value	0.1 μ F	0.1 μ F	0.1 μ F	4.7 μ H	130 Ω	150 Ω	8 Pin DC Header	SMA JACK
Location	C1,C5,C7, C9,C13, C15, C19, C25, C27	C2,C6,C8, C10,C14,C16, C22,C26,C28	C3,C4,C11, C12,C20,C21, C23,C24	L1 to L9	R1	R2,R3,R4	P1	J0 – J5
Specs , Mfg	CER, 25 V , 10% ,0603, Panasonic	CER, 25 V , 10% ,0603, Panasonic	CER, 25 V , 10% ,0603, Panasonic	4.7 μ H, 125 mA ,1.55, 10% ,1008, Panasonic	1W, 5%,2512 Thick Film Panasonic	1W, 1%,2512 , Thick Film, Panasonic	8 Pos, Rectangular Head , Male PIN 0.100R/A , 15 AU, FCI	Conn Jack SMA , 50 Ohm Edge Mount , Amphenol
Mfg #	ECJ-1VB1E104K	ECJ-1VB1E104K	ECJ-1VB1E104K	ELJ-FC4R7KF	ERJ-1TYJ131U	ERJ-1TYJ151U	68016-208HLF	901-10309
Digikey #	PCC2277TR-ND	PCC2277TR-ND	PCC2277TR-ND	PCD1069TR-ND	PT130XTR-ND	PT150XTR-ND	609-3321-ND	ARF1744-ND

MSW3201-320 Band 2 Evaluation Board BOM

Item	DC Blocking Caps	RF Bypass Caps	Second Bypass Cap	Inductor	Resistor	Resistor	Header Pin	SMA Connector
Value	22 pF	270 pF	1000 pF	82 nH	130 Ω	150 Ω	8 Pin DC Header	SMA JACK
Location	C1,C5,C7,C13, C15,C27	C2,C6,C8,C14 ,C16,C28	C3,C4,C9,C10 ,C11,C12	L1 to L9	R1	R2, R4,R5	P1	J0 – J5
Specs , Mfg	CER, 100 V , 5% ,0603, Murata	CER, 50 V , 5% ,0603, Murata	CER, 50 V , 10% ,0603, Murata	82 nH, 250 mA ,1.5 Ω , 2% ,0603, Panasonic	1W, 5%,2512 Thick Film Panasonic	1W, 1%,2512 , Thick Film, Panasonic	8 Pos, Rectangular Head , Male PIN 0.100R/A ,15 AU, FCI	Conn Jack SMA , 50 Ohm Edge Mount, Amphenol
Mfg #	GRM1885C2A 220JA01D	GRM1885C1H 271JA01D	GRM188R71H 102KA01D	ELJ-RE82NGFA	ERJ-1TYJ131U	ERJ-1TYJ151U	68016-208HLF	901-10309
Digikey #	490-1335-2-ND	490-1437-2-ND	490-1494-2-ND	PCD2013CT-ND	PT130XTR-ND	PT150XTR-ND	609-3321-ND	ARF1744-ND

Assembly Instructions

The MSW3200-320 and MSW3201-320 switches are capable of being placed onto circuit boards with pick and place manufacturing equipment from tube or tape-reel dispensing. The devices are attached to the circuit board using conventional solder re-flow or wave soldering procedures with RoHS type or Sn60/Pb40-type solders per Table I and Figure I.

Table 1. Time-Temperature Profile for Sn60/Pb40 or RoHS Type Solders

Profile Feature	SnPb Solder Assembly	Pb-Free Solder Assembly
Average Ramp-Up Rate (T_L to T_p)	3 °C /second maximum	3 °C /second maximum
Preheat:		
- Temperature Min ($T_{S_{MIN}}$)	100 °C	150 °C
- Temperature Max ($T_{S_{MAX}}$)	150 °C	200 °C
- Time (min to max)(t_p)	60-120 s	60-180 s
$T_{S_{MAX}}$ to T_L		
- Ramp-Up Rate		3 °C/s maximum
Time Maintained Above:		
- Temperature	183 °C	217 °C
(T_L) - Time (t_L)	60-150 s	60-150 s
Peak temperature (T_p)	225 +0/-5 °C	260 +0/-5 °C
Time Within 5 °C of Actual Peak Temperature (t_p)	10 – 30 s	20 – 40 s
Ramp-Down Rate	6 °C /s maximum	6 °C /s maximum
Time 25 °C to Peak Temperature	6 minutes maximum	8 minutes maximum

Figure 1. Solder Re-Flow Time-Temperature Profile

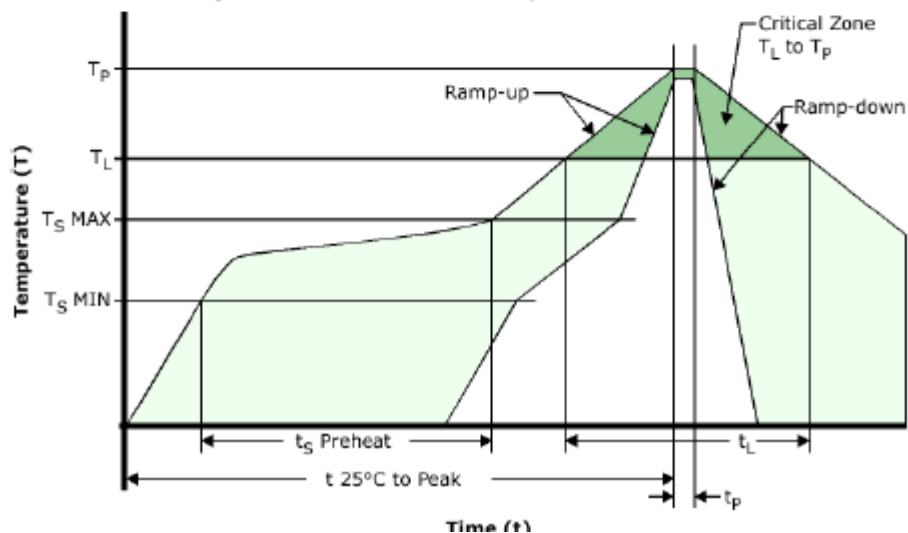

SP3T Switch Outline for Case Style 310 (CS310)

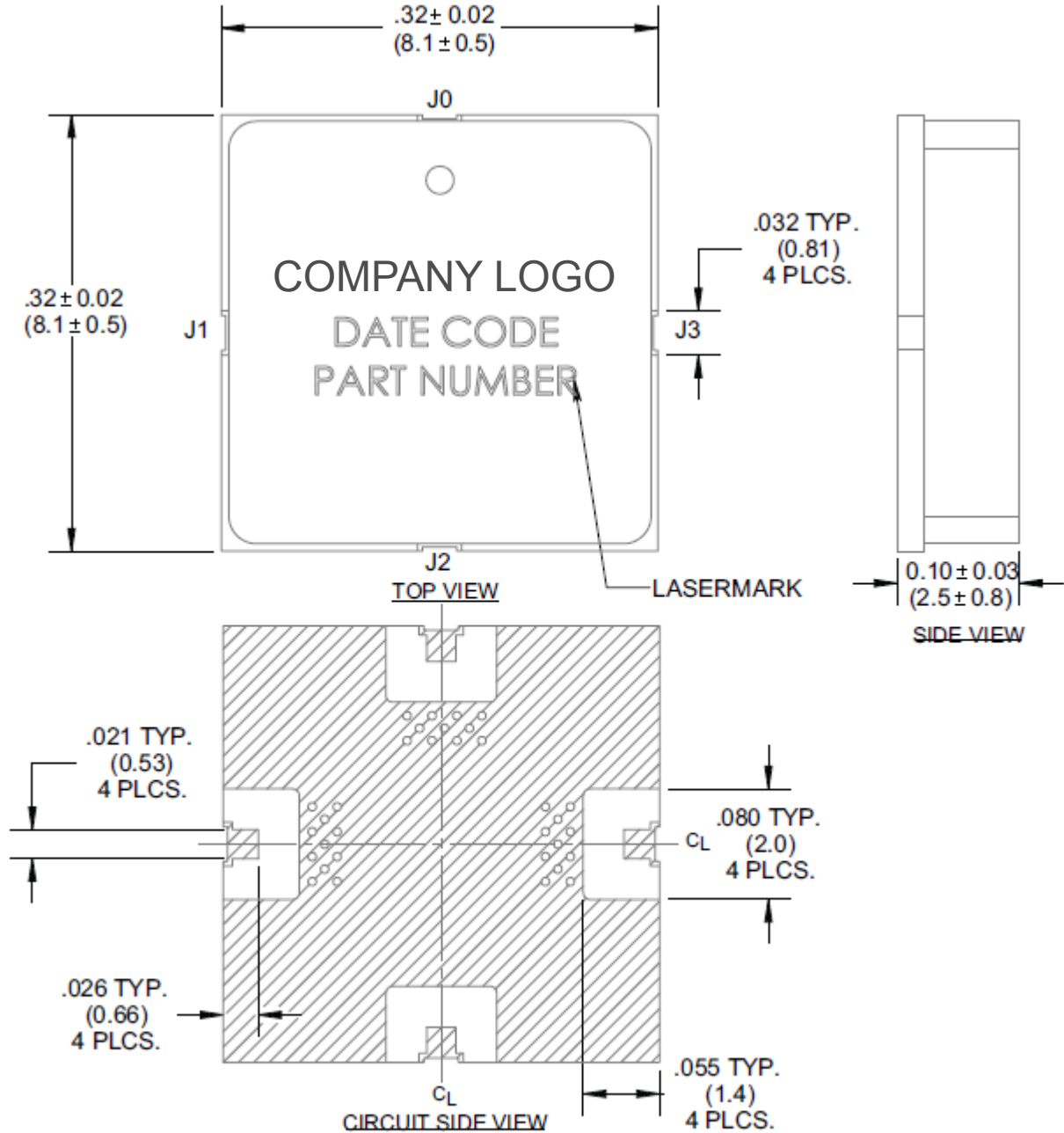

Notes:

1. Hatched Metal Area on Circuit Side of Device is RF, D.C., and Thermal Ground.

RF Circuit Solder Footprint for Case Style 320 (CS320)

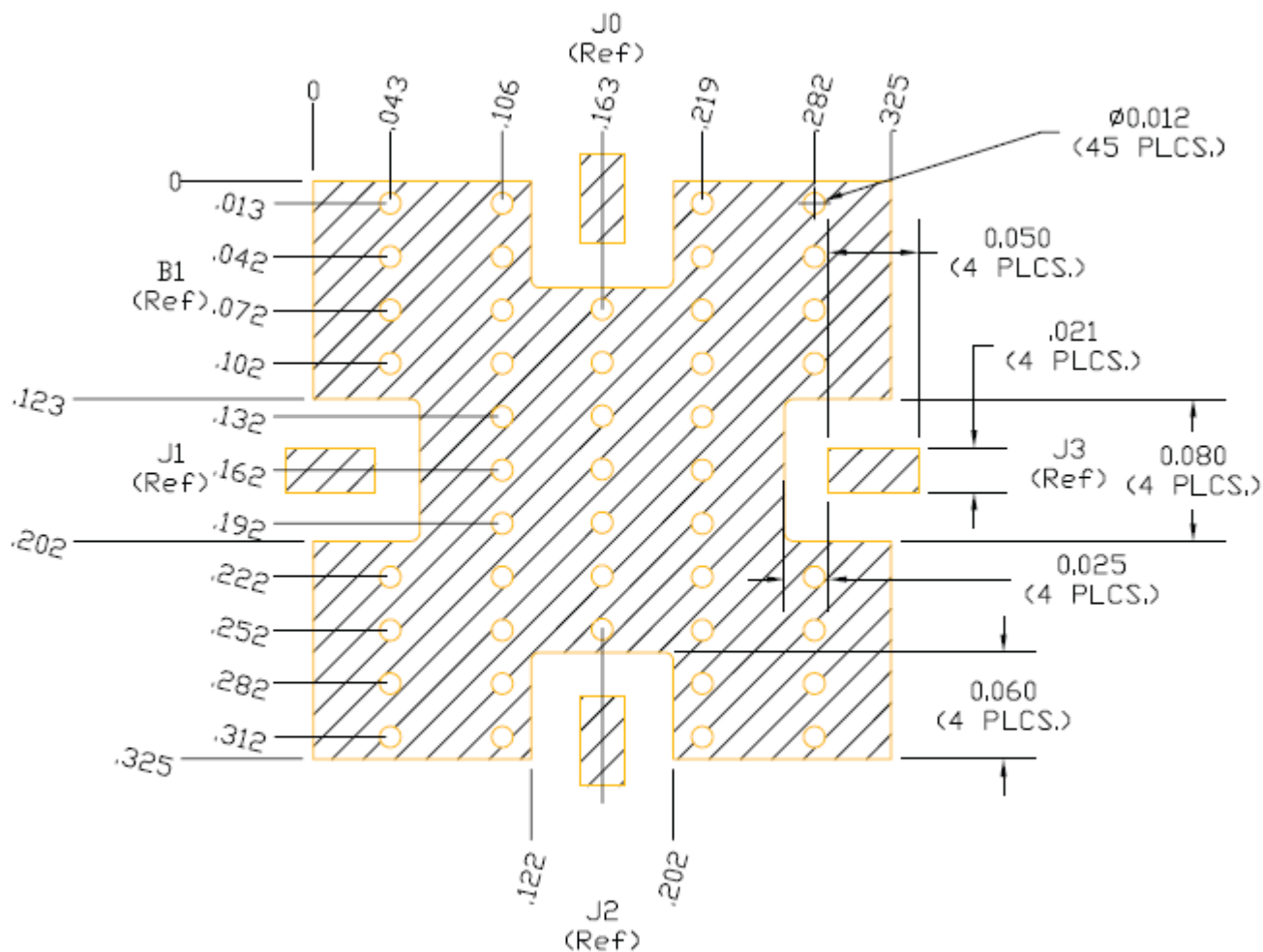

Hatched area is RF, DC, and thermal Ground. Vias should be solid copper fill and gold plated for optimum heat transfer from backside of switch module through Circuit Vias to metal thermal ground.

Part Number Ordering Information

Part Number	Description	Packaging
MSW3200-320-T		Tube
MSW3200-320-R		Tape-Reel (Quantities of 250 or 500)
MSW3200-320-W		Waffle Pack
MSW3201-320-T		Tube
MSW3201-320-R		Tape-Reel (Quantities of 250 or 500)
MSW3201-320-W		Waffle Pack
MSW3200-320-E		RF Evaluation Board
MSW3201-320-E		RF Evaluation Board

* RF Evaluation boards are rated at + 45 dBm C.W. or Peak Incident Power due to the RF power rating values of the Passive L, C Bias Elements.

M/A-COM Technology Solutions Inc. All rights reserved.

Information in this document is provided in connection with M/A-COM Technology Solutions Inc ("MACOM") products. These materials are provided by MACOM as a service to its customers and may be used for informational purposes only. Except as provided in MACOM's Terms and Conditions of Sale for such products or in any separate agreement related to this document, MACOM assumes no liability whatsoever. MACOM assumes no responsibility for errors or omissions in these materials. MACOM may make changes to specifications and product descriptions at any time, without notice. MACOM makes no commitment to update the information and shall have no responsibility whatsoever for conflicts or incompatibilities arising from future changes to its specifications and product descriptions. No license, express or implied, by estoppel or otherwise, to any intellectual property rights is granted by this document.

THESE MATERIALS ARE PROVIDED "AS IS" WITHOUT WARRANTY OF ANY KIND, EITHER EXPRESS OR IMPLIED, RELATING TO SALE AND/OR USE OF MACOM PRODUCTS INCLUDING LIABILITY OR WARRANTIES RELATING TO FITNESS FOR A PARTICULAR PURPOSE, CONSEQUENTIAL OR INCIDENTAL DAMAGES, MERCHANTABILITY, OR INFRINGEMENT OF ANY PATENT, COPYRIGHT OR OTHER INTELLECTUAL PROPERTY RIGHT. MACOM FURTHER DOES NOT WARRANT THE ACCURACY OR COMPLETENESS OF THE INFORMATION, TEXT, GRAPHICS OR OTHER ITEMS CONTAINED WITHIN THESE MATERIALS. MACOM SHALL NOT BE LIABLE FOR ANY SPECIAL, INDIRECT, INCIDENTAL, OR CONSEQUENTIAL DAMAGES, INCLUDING WITHOUT LIMITATION, LOST REVENUES OR LOST PROFITS, WHICH MAY RESULT FROM THE USE OF THESE MATERIALS.

MACOM products are not intended for use in medical, lifesaving or life sustaining applications. MACOM customers using or selling MACOM products for use in such applications do so at their own risk and agree to fully indemnify MACOM for any damages resulting from such improper use or sale.