



# M1 THRU M7

Reverse Voltage - 50 to 1000 Volts Forward Current - 1.0 Ampere

## SURFACE MOUNT GENERAL RECTIFIER

### Features

- ◆ The plastic package carries Underwriters Laboratory Flammability Classification 94V-0
- ◆ Idea for printed circuit board
- ◆ Glass passivated Junction chip
- ◆ Low reverse leakage
- ◆ High forward surge current capability
- ◆ High temperature soldering guaranteed  
250 C/10 seconds at terminals

DO-214AC/SMA

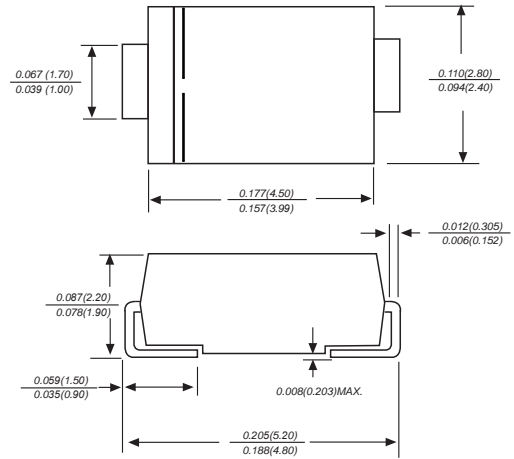

Dimensions in inches and (millimeters)

### Mechanical Data

**Case :** JEDEC DO-214AC/SMA Molded plastic body

**Terminals :** Solder plated, solderable per MIL-STD-750, Method 2026

**Polarity :** Polarity symbol marking on body

**Mounting Position :** Any

**Weight :** 0.0023 ounce, 0.07 grams

### Maximum Ratings And Electrical Characteristics

Ratings at 25°C ambient temperature unless otherwise specified.

Single phase half-wave 60Hz, resistive or inductive load, for capacitive load current derate by 20%.

Parameter	SYMBOLS	M1	M2	M3	M4	M5	M6	M7	UNITS
		MDD M1	MDD M2	MDD M3	MDD M4	MDD M5	MDD M6	MDD M7	
Maximum repetitive peak reverse voltage	$V_{RRM}$	50	100	200	400	600	800	1000	V
Maximum RMS voltage	$V_{RMS}$	35	70	140	280	420	560	700	V
Maximum DC blocking voltage	$V_{DC}$	50	100	200	400	600	800	1000	V
Maximum average forward rectified current at $T_L=110^\circ\text{C}$	$I_{(AV)}$	1.0							A
Peak forward surge current 8.3ms single half sine-wave superimposed on rated load (JEDEC Method)	$I_{FSM}$	30							A
Maximum instantaneous forward voltage at 1.0A	$V_F$	1.10							V
Maximum DC reverse current $T_A=25^\circ\text{C}$ at rated DC blocking voltage $T_A=125^\circ\text{C}$	$I_R$	5 50							$\mu\text{A}$
Typical junction capacitance (NOTE 1)	$C_J$	15.0							pF
Typical thermal resistance (NOTE 2)	$R_{\theta JA}$	75.0							$^\circ\text{C}/\text{W}$
Operating junction and storage temperature range	$T_J, T_{STG}$	-55 to +150							$^\circ\text{C}$

**Note:** 1. Measured at 1MHz and applied reverse voltage of 4.0V D.C.  
2. P.C.B. mounted with 0.2x0.2" (5.0x5.0mm) copper pad areas



# M1 THRU M7

Reverse Voltage - 50 to 1000 Volts Forward Current - 1.0 Ampere

## Ratings And Characteristic Curves

AVERAGE FORWARD RECTIFIED CURRENT, AMPERES

FIG. 1- FORWARD CURRENT DERATING CURVE

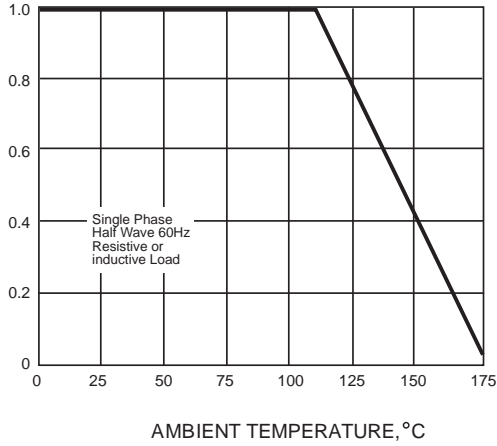

PEAK FORWARD SURGE CURRENT, AMPERES

FIG. 2-MAXIMUM NON-REPETITIVE PEAK FORWARD SURGE CURRENT

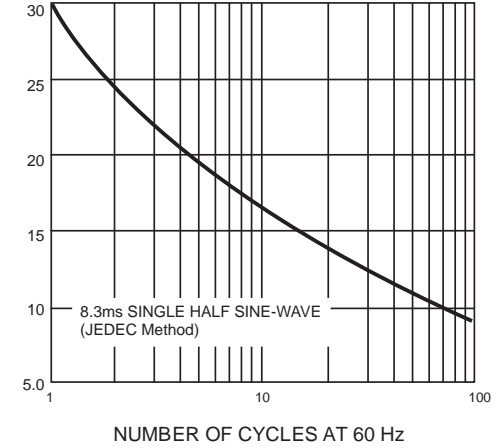
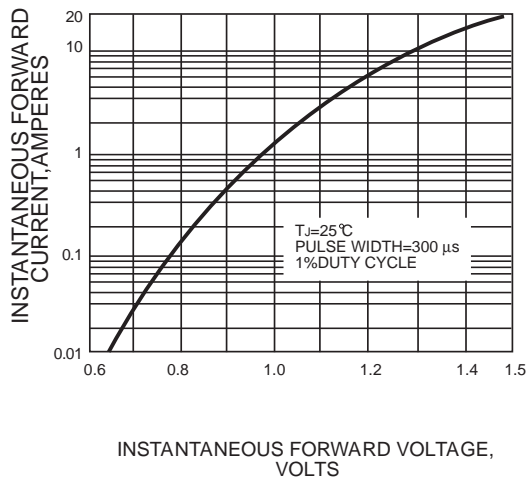

FIG. 3-TYPICAL INSTANTANEOUS FORWARD CHARACTERISTICS



INSTANTANEOUS REVERSE CURRENT, MICROAMPERES

FIG. 4-TYPICAL REVERSE CHARACTERISTICS

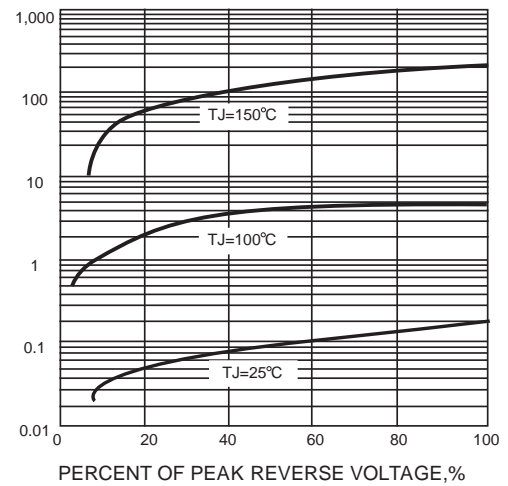
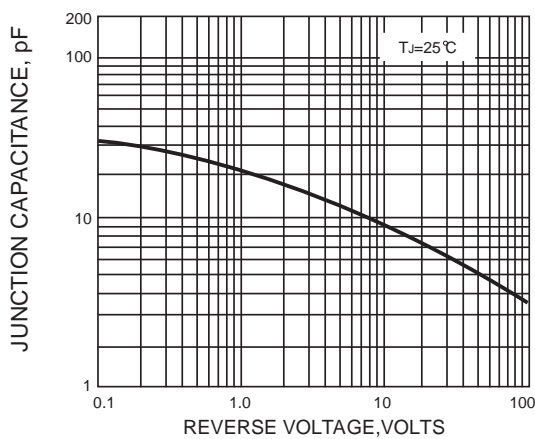
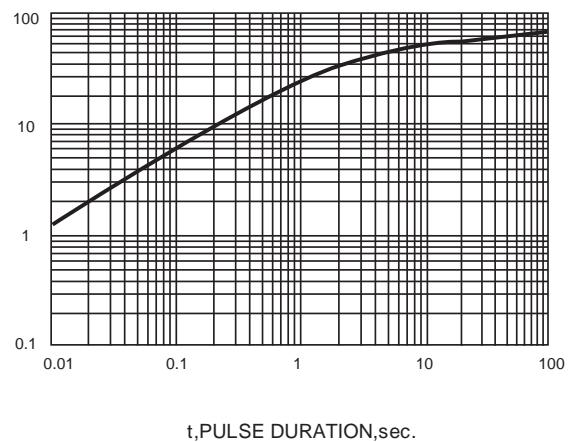

FIG. 5-TYPICAL JUNCTION CAPACITANCE



TRANSIENT THERMAL IMPEDANCE, °C/W

FIG. 6-TYPICAL TRANSIENT THERMAL IMPEDANCE



The curve above is for reference only.



# M1 THRU M7

Reverse Voltage - 50 to 1000 Volts Forward Current - 1.0 Ampere

## Packing information

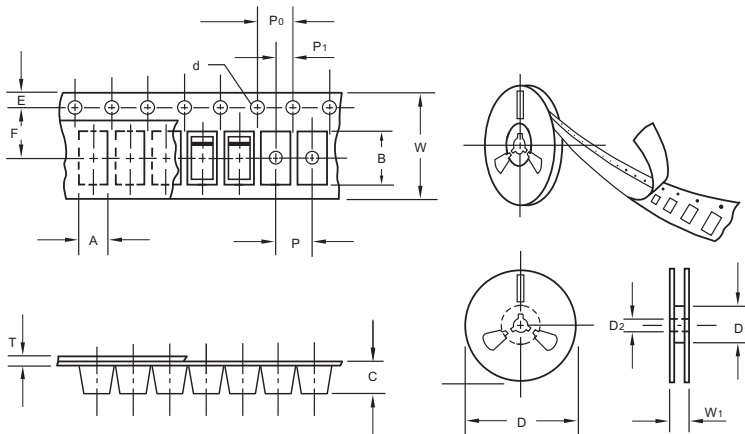

unit:mm

Item	Symbol	Tolerance	SMA
Carrier width	A	0.1	2.80
Carrier length	B	0.1	5.33
Carrier depth	C	0.1	2.36
Sprocket hole	d	0.05	1.50
13" Reel outside diameter	D	2.0	330.00
13" Reel inner diameter	D <sub>1</sub>	min	50.00
7" Reel outside diameter	D	2.0	178.00
7" Reel inner diameter	D <sub>1</sub>	min	62.00
Feed hole diameter	D <sub>2</sub>	0.5	13.00
Sprocket hole position	E	0.1	1.75
Punch hole position	F	0.1	5.50
Punch hole pitch	P	0.1	4.00
Sprocket hole pitch	P <sub>0</sub>	0.1	4.00
Embossment center	P <sub>1</sub>	0.1	2.00
Overall tape thickness	T	0.1	0.28
Tape width	W	0.3	12.00
Reel width	W <sub>1</sub>	1.0	18.00

Note: Devices are packed in accordance with EIA standard RS-481-A and specifications listed above.

## Reel packing

PACKAGE	REEL SIZE	REEL (pcs)	COMPONENT SPACING (m/m)	BOX (pcs)	INNER BOX (m/m)	REEL DIA, (m/m)	CARTON SIZE (m/m)	CARTON (pcs)	APPROX. GROSS WEIGHT (kg)
SMA	7"	2,000	4.0	4,000	183*155*183	178	382*356*392	80,000	16.0
SMA	11"	5,000	4.0	10,000	290*290*38	330	310*310*360	80,000	11.0
SMA	13"	7,500	4.0	15,000	335*335*38	330	350*330*360	120,000	14.5

## Suggested Pad Layout



Symbol	Unit (mm)	Unit (inch)
A	1.68	0.066
B	1.52	0.060
C	3.90	0.154
D	2.41	0.095
E	5.45	0.215

## Important Notice and Disclaimer

Microdiode Electronics (Jiangsu) reserves the right to make changes to this document and its products and specifications at any time without notice. Customers should obtain and confirm the latest product information and specifications before final design, purchase or use.

Microdiode Electronics (Jiangsu) makes no warranty, representation or guarantee regarding the suitability of its products for any particular purpose, nor does Microdiode Electronics (Jiangsu) assume any liability for application assistance or customer product design. Microdiode Electronics (Jiangsu) does not warrant or accept any liability with products which are purchased or used for any unintended or unauthorized application.

No license is granted by implication or otherwise under any intellectual property rights of Microdiode Electronics (Jiangsu).

Microdiode Electronics (Jiangsu) products are not authorized for use as critical components in life support devices or systems without express written approval of Microdiode Electronics (Jiangsu).