

3 Volt, Low Noise High f_T Silicon Transistor

MA4T6310 Series

V 2.00

Features

- 1.5 dB Noise Figure at 0.5 mA
- 13 dB Gain at 1 GHz
- 14 GHz f_T
- Low Cost Plastic Package
- Available on Tape and Reel

Description

The MA4T6310 series of low current, high f_T silicon NPN bipolar transistors provides low noise figure at a bias of 3 volts and small collector current. These inexpensive surface mount NPN transistors are well suited for usage in portable battery operated wireless systems from 500 MHz through 2.5 GHz where low noise figure at small current is important.

The MA4T6310 transistor series has high f_T and low noise when operated with 0.3 to 2.0 milliamperes current, and 3 volt bias. The associated gain is approximately 14 dB at 1 GHz with 1 mA collector current. The MA4T6310 also has low phase noise while operating in a low power 3-5 volt battery operated VCO in the frequency range of 0.5 to 3 GHz.

The MA4T6310 transistor is useful for wireless communication systems from VHF through L-band where good noise figure and high gain at 3 volt bias and low DC current are key system requirements. Suggested uses include, 900 MHz portable phones, pagers, PCN subscriber phones and 2.4 GHz cordless and cellular hand held receivers.

The MA4T6310 is available as a chip (MA4T631000), in the SOT-23 (MA4T631033), the SOT-143 (MA4T631039), and in the Micro-X (MA4T631035) packages. Surface mount packages are available on tape and reel.

SOT-23

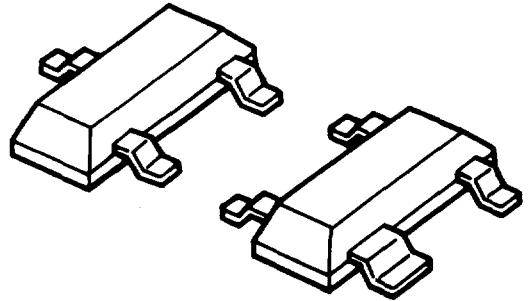

SOT-143

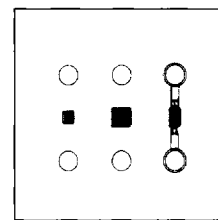

Chip

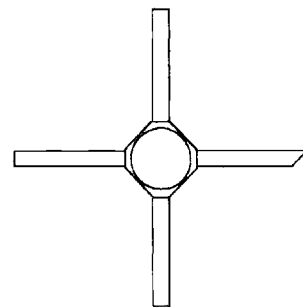

Micro-X

Maximum Ratings @ +25°C

Parameter	Symbol	Maximum Rating
Collector-Base Voltage	V_{CBO}	8 V
Collector-Emitter Voltage	V_{CEO}	6 V
Emitter-Base Voltage	V_{EBO}	1.5 V
Collector Current	I_C	10 mA
Junction Temperature	T_j	200 °C
Storage Temperature Chips or Ceramic Packages Plastic Packages	T_{STG}	-65°C to +200°C -65°C to +125°C
Power Dissipation	P_D	-60mW ¹

Note: 1. See power derating curve.

Electrical Specifications @ +25°C

MA4T6310 Series

Parameter	Condition	Symbol	Units	MA4T631035 Micro-X	MA4T631033 SOT-23	MA4T631039 SOT-143	MA4T631000 Chlp
Gain Bandwidth Product	$V_{CE} = 3\text{ V}$ $I_C = 6\text{ mA}$	f_T	GHz	14 typ.	12 typ.	12 typ.	14 typ.
Insertion Power Gain	$V_{CE} = 3\text{ V}$ $I_C = 4\text{ mA}$ $f = 1\text{ GHz}$ $f = 2\text{ GHz}$	$IS_{21E} ^2$	dB	12 typ. 8 typ.	11 typ. 7 typ.	11 typ. 7 typ.	12 typ. 8 typ.
Noise Figure	$V_{CE} = 3\text{ V}$ $I_C = 0.5\text{ mA}$ $I_C = 1\text{ mA}$ $f = 1\text{ GHz}$	NF	dB	1.5 typ.	1.5 typ.	1.5 typ.	1.5 typ.
Unilateral Gain	$V_{CE} = 3\text{ V}$ $I_C = 4\text{ mA}$ $f = 1\text{ GHz}$ $f = 2\text{ GHz}$	GTU (max)	dB	14.5 typ. 9 typ.	13 typ. 8 typ.	13 typ. 8 typ.	14.5 typ. 9 typ.
Maximum Available Gain	$V_{CE} = 3\text{ V}$ $I_C = 4\text{ mA}$ $f = 2\text{ GHz}$	MAG	dB	10 typ.	10 typ.	10 typ.	10 typ.
Power Out at 1 dB Compression	$V_{CE} = 3\text{ V}$ $I_C = 8\text{ mA}$ $f = 1\text{ GHz}$	P_{1dB}	dBm	1.5 typ.	1.5 typ.	1.5 typ.	1.5 typ.
Thermal Resistance	Junction/ Ambient	$R_{TH}(J-A)$	°C/W	600 typ. ²	700 typ. ²	700 typ. ²	75 max. ¹

Notes:

- Junction/Heat Sink R_{TH} (J-C)
- Free Air

Specifications Subject to Change Without Notice.

Electrical Specifications @ +25°C
MA4T6310 Series

Parameter	Condition	Symbol	Min	Typical	Max	Unit
Collector Cut-off Current	$V_{CB} = 3\text{ V}$ $I_E = 0$	I_{CBO}	—	—	100	nA
Emitter Cut-off Current	$V_{EB} = 1\text{ V}$ $I_C = 0$	I_{EBO}	—	—	1	μA
Forward Current Gain	$V_{CE} = 3\text{ V}$ $I_C = 3\text{ mA}$	h_{FE}	20	100	200	—
Collector-Base Junction Capacitance	$V_{CB} = 3\text{ V}$ $I_E = 0$ $f = 1\text{ MHz}$	C_{OB}	—	0.42	0.55	pF

Typical Noise Parameters in the Micro-X Package
MA4T631035

Frequency GHz	I_C (mA)	NF _o (dB)	GA (dB)	Γ_{OPT}		R _n
				(Mag)	(Angle)	
2.00	0.5	1.96	3.4	0.66	59.6	45.0
2.00	1.0	2.37	5.1	0.58	63.1	39.2
2.00	2.0	2.88	6.9	0.44	72.0	32.4
3.00	0.5	2.22	2.1	0.55	88.2	28.8
3.00	1.0	2.53	3.3	0.48	91.8	25.5
3.00	2.0	3.05	4.5	0.37	100.8	22.1

Typical Scattering Parameters in the Micro-X Package
MA4T631035

$V_{CE} = 3\text{ Volts}, I_C = 2\text{ mA}$

Frequency (MHz)	S_{11E}		S_{21E}		S_{12E}		S_{22E}	
	Mag	Angle	Mag	Angle	Mag	Angle	Mag	Angle
500	0.744	-37.9	4.174	137.0	0.088	63.8	0.841	-31.2
1000	0.524	-69.7	3.435	109.7	0.136	51.4	0.645	-48.2
1500	0.357	-94.3	2.771	89.9	0.169	45.5	0.531	-57.9
2000	0.255	-118.6	2.308	75.0	0.201	41.2	0.463	-67.5
2500	0.188	-142.6	1.977	62.3	0.228	37.3	0.415	-75.2
3000	0.139	-171.1	1.719	51.5	0.254	33.8	0.383	-81.9
3500	0.130	168.9	1.587	41.9	0.281	29.1	0.360	91.2
4000	0.133	140.6	1.448	33.1	0.299	25.8	0.342	-97.9
4500	0.156	122.4	1.369	23.1	0.323	21.8	0.324	-107.8
5000	0.180	105.0	1.296	15.5	0.342	17.9	0.308	-115.4
5500	0.204	89.7	1.239	7.9	0.362	14.3	0.299	-123.5
6000	0.228	78.9	1.194	0.7	0.379	10.7	0.292	-132.8

Specifications Subject to Change Without Notice.

M/A-COM, Inc.

North America: Tel. (800) 366-2266
Fax (800) 618-8883

■ Asia/Pacific: Tel. +81 (03) 3226-1671
Fax +81 (03) 3226-1451

■ Europe: Tel. +44 (1344) 869 595
Fax +44 (1344) 300 020

Typical Scattering Parameters in the Micro-X (Con't)

MA4T631035

 $V_{CE} = 3$ Volts, $I_C = 4$ mA

Frequency (MHz)	S_{11E}		S_{21E}		S_{12E}		S_{22E}	
	Mag	Angle	Mag	Angle	Mag	Angle	Mag	Angle
500	0.558	-54.5	6.582	127.1	0.074	61.9	0.727	-37.0
1000	0.324	-92.2	4.537	98.8	0.114	54.8	0.523	-49.9
1500	0.217	-119.0	3.299	82.1	0.149	51.4	0.437	-56.5
2000	0.169	-150.7	2.635	69.2	0.184	47.4	0.387	-65.3
2500	0.147	172.8	2.204	58.0	0.215	43.3	0.353	-72.2
3000	0.141	148.6	1.888	48.1	0.244	39.4	0.330	-78.6
3500	0.145	134.2	1.719	39.3	0.274	34.5	0.315	-88.4
4000	0.167	115.0	1.562	30.9	0.296	30.7	0.305	-95.7
4500	0.196	103.5	1.465	21.3	0.322	26.2	0.288	-106.1
5000	0.223	90.9	1.381	13.9	0.343	22.0	0.275	-114.0
5500	0.251	79.0	1.314	6.4	0.365	17.8	0.267	-122.7
6000	0.275	69.7	1.260	-1.4	0.383	14.1	0.262	-132.5

MA4T631035

 $V_{CE} = 3$ Volts, $I_C = 6$ mA

Frequency (MHz)	S_{11E}		S_{21E}		S_{12E}		S_{22E}	
	Mag	Angle	Mag	Angle	Mag	Angle	Mag	Angle
500	0.429	-67.5	7.855	120.2	0.067	62.5	0.656	-39.5
1000	0.244	-107.3	4.871	93.9	0.107	57.9	0.466	-49.4
1500	0.178	-136.4	3.445	78.8	0.144	54.7	0.397	-54.9
2000	0.160	-168.7	2.722	66.7	0.179	50.3	0.354	-63.5
2500	0.158	163.5	2.264	56.0	0.212	45.9	0.326	-70.3
3000	0.166	138.7	1.933	46.4	0.241	41.5	0.306	-76.9
3500	0.170	126.8	1.753	37.9	0.273	36.5	0.295	-87.3
4000	0.192	109.9	1.584	29.8	0.294	32.8	0.289	-94.3
4500	0.221	100.9	1.490	20.2	0.322	28.1	0.275	-106.0
5000	0.250	89.2	1.403	13.0	0.344	23.8	0.263	-114.7
5500	0.280	77.8	1.333	5.3	0.367	19.4	0.255	-124.2
6000	0.304	68.6	1.276	-2.4	0.385	15.7	0.254	-134.7

Specifications Subject to Change Without Notice.

8-12

M/A-COM, Inc.

North America: Tel. (800) 366-2266
Fax (800) 618-8883■ Asia/Pacific: Tel. +81 (03) 3226-1671
Fax +81 (03) 3226-1451■ Europe: Tel. +44 (1344) 869 595
Fax +44 (1344) 300 020

Typical Performance Curves

POWER DERATING CURVES

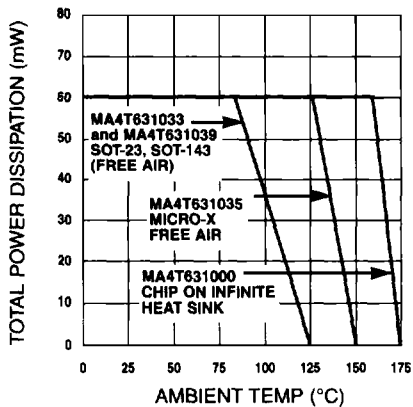

COLLECTOR-BASE CAPACITANCE (C_{OB}) vs COLLECTOR-BASE VOLTAGE (MA4T631035)

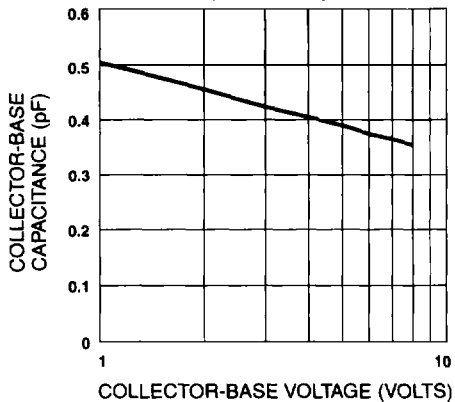

GAIN vs FREQUENCY AT $V_{CE} = 3V$ AND $I_C = 4mA$ (MA4T631035)

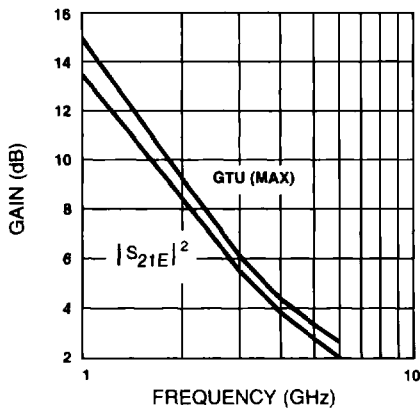

GAIN vs COLLECTOR CURRENT AT 3 GHz AND $V_{CE} = 3V$ (MA4T631035)

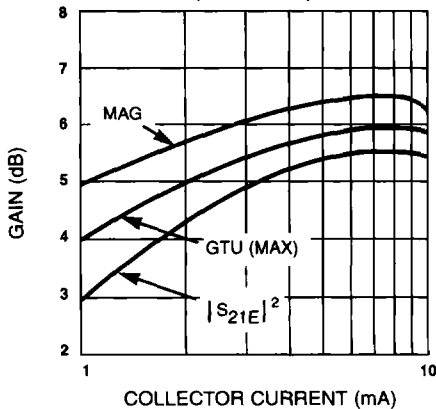

Specifications Subject to Change Without Notice.

M/A-COM, Inc.

8-13

North America: Tel. (800) 366-2266 Fax (800) 618-8883
 Asia/Pacific: Tel. +81 (03) 3226-1671 Fax +81 (03) 3226-1451
 Europe: Tel. +44 (1344) 869 595 Fax +44 (1344) 300 020

Typical Performance Curves (Con't)

GAIN BANDWIDTH PRODUCT (f_T) vs
COLLECTOR CURRENT AT $V_{CE} = 3V$
(MA4T631035)

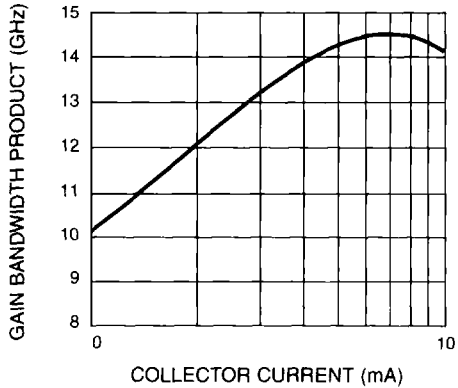

DC CURRENT GAIN (H_{FE}) vs
COLLECTOR CURRENT AT $V_{CE} = 3V$
(MA4T631035)

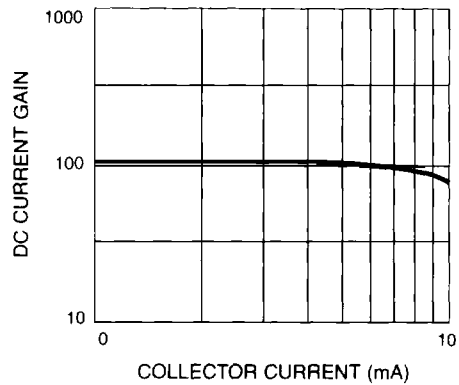

NOISE FIGURE AND ASSOCIATED
GAIN AT 1 GHz AND $V_{CE} = 3V$
vs COLLECTOR CURRENT
(MA4T631035)

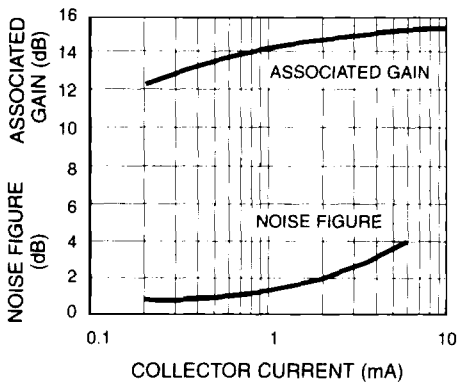

NOMINAL OUTPUT POWER AT THE
1 dB COMPRESSION POINT vs
COLLECTOR CURRENT $V_{CE} = 3V$
(MA4T631035)

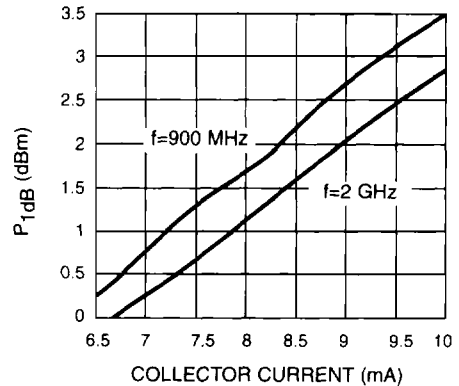

Specifications Subject to Change Without Notice.

Case Styles

Chip — MA4T631000
Case Style 1165

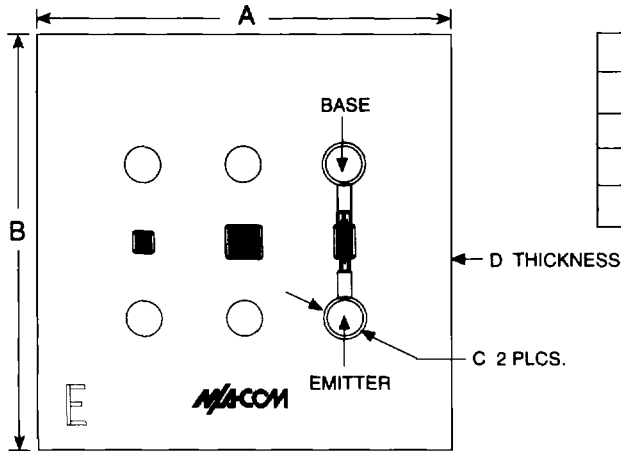

MA4T631000

DIM.	INCHES (Nominal)	MM (Nominal)
A	0.013	0.35
B	0.013	0.35
C	0.0012	0.030
D	0.0045	0.11

SOT-23 — MA4T631033
(High Profile)

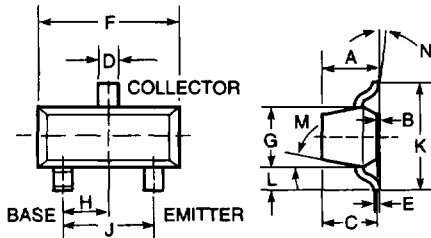

MA4T631033

DIM.	INCHES		MILLIMETERS	
	MIN.	MAX.	MIN.	MAX.
A	—	0.044	—	1.12
B	—	0.004	—	0.10
C	—	0.040	—	1.00
D	0.013	0.020	0.35	0.50
E	0.003	0.006	0.08	0.15
F	0.110	0.119	2.80	3.00
G	0.047	0.056	1.20	1.40
H	0.037 typical		0.95 typical	
J	0.075 typical		1.90 typical	
K	—	0.103	—	2.60
L	—	0.024	—	0.60

DIM.	GRADIENT
M	10° max.1
N	2°...30°

Note:
1. Applicable on all sides

Specifications Subject to Change Without Notice.

M/A-COM, Inc.

8-15

North America: Tel. (800) 366-2266 ■ Asia/Pacific: Tel. +81 (03) 3226-1671 ■ Europe: Tel. +44 (1344) 869 595
Fax (800) 618-8883 Fax +81 (03) 3226-1451 Fax +44 (1344) 300 020

Case Styles (Con't)

Micro-X — MA4T630535
Case Style 1139

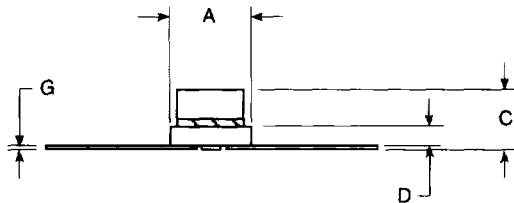
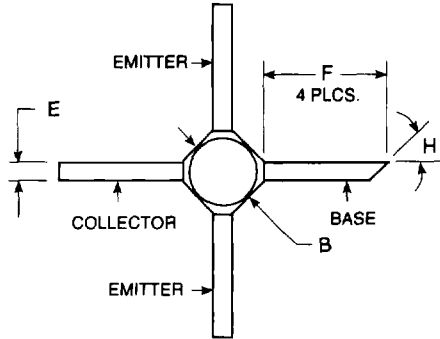

MA4T630535

DIM.	INCHES		MILLIMETERS	
	MIN.	MAX.	MIN.	MAX.
A	0.092	0.108	2.34	2.74
B	0.079	0.087	2.01	2.21
C	—	0.070	—	1.78
D	0.019	0.025	0.48	0.64
E	0.018	0.022	0.046	0.56
F	0.150	—	3.81	—
G	0.003	0.006	0.08	0.15
H	45°		45°	

MA4T630539

SOT-143 — MA4T630539

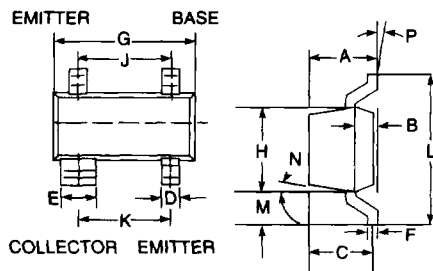

DIM.	INCHES		MILLIMETERS	
	MIN.	MAX.	MIN.	MAX.
A	—	0.044	—	1.10
B	—	0.044	—	1.10
C	—	0.040	—	1.00
D	0.030	0.035	0.75	0.90
E	0.013	0.020	0.35	0.50
F	0.003	0.006	0.08	0.15
G	0.110	0.119	2.80	3.00
H	0.047	0.056	1.20	1.40
J	0.075 TYPICAL		1.90 TYPICAL	
K	0.075 TYPICAL		1.90 TYPICAL	
L	—	0.103	—	2.6
M	—	0.024	—	0.6

DIM.	GRADIENT
N	10° max.1
P	2°...30°