

1 550 nm CW LIGHT SOURCE InGaAsP MQW-DFB LASER DIODE MODULE WITH WAVELENGTH MONITOR

DESCRIPTION

The NX8571 Series is a 1 550 nm Multiple Quantum Well (MQW) structured Distributed Feed-Back (DFB) laser diode module with wavelength monitor function. This device is temperature tunable over 4×50 GHz channels. Available at both C-band (1 530.334 to 1 565.087 nm) and L-band (1 565.496 to 1 608.760 nm) ITU-T grid wavelengths.

This device is designed as CW light source and ideal for transmission systems in which external modulators are used.

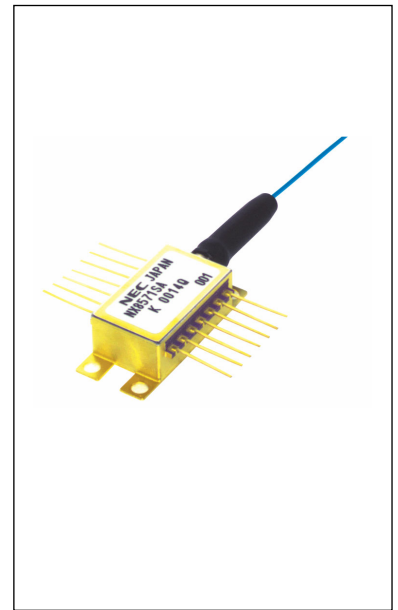

FEATURES

- Wavelength monitor function (Etalon Filter, Wavelength monitor PD)
- Optical output power : $P_f = 10$ mW MIN.
- Available for DWDM wavelengths based on ITU-T recommendations (50 GHz grid, please refer to the **ORDERING INFORMATION**)
- 4 channel wavelength tunable capability for 50 GHz-spacing (NX8571SCxxxD)
- Internal thermo-electric cooler and isolator
- Hermetically sealed 14-pin butterfly package
- Polarization maintain fiber pigtail

The information in this document is subject to change without notice. Before using this document, please confirm that this is the latest version.
Not all devices/types available in every country. Please check with local NEC Compound Semiconductor Devices representative for availability and additional information.

★ PACKAGE DIMENSIONS (UNIT : mm)

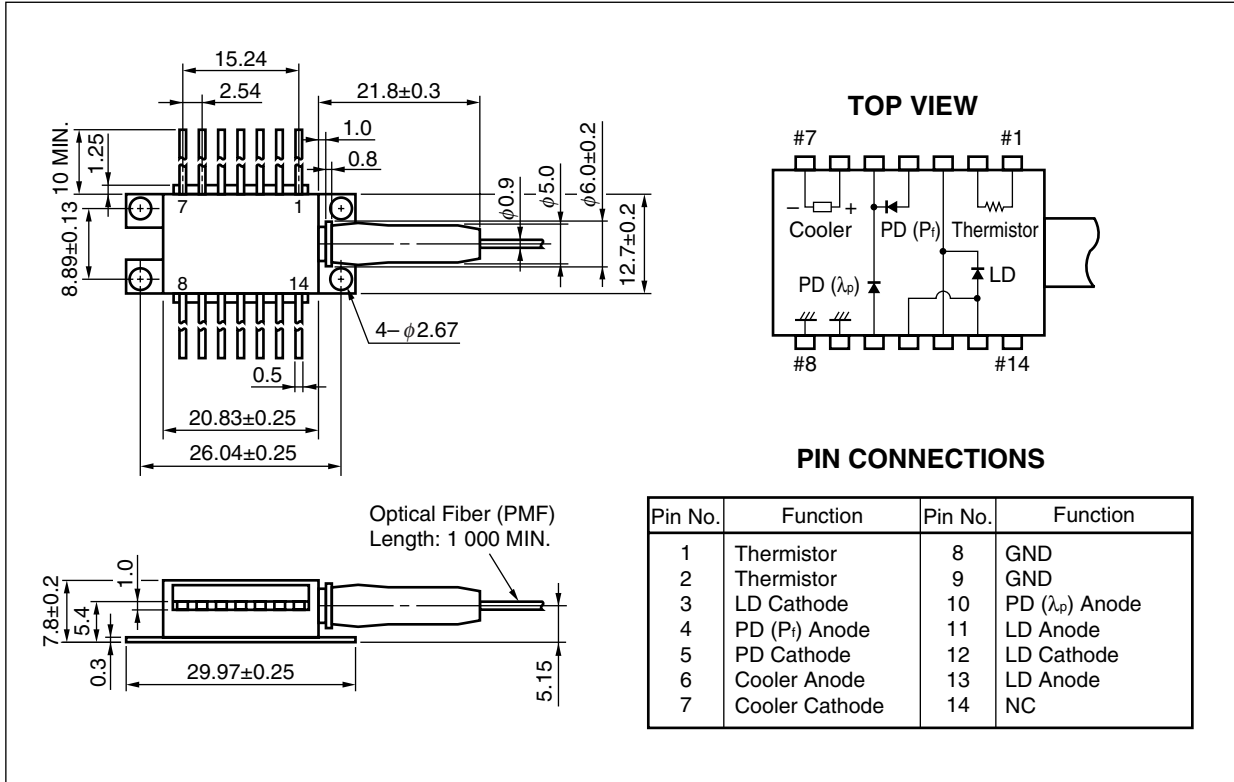

OPTICAL FIBER CHARACTERISTICS

Parameter	Specification	Unit
Outer Diameter	0.9±0.1	mm
Minimum Fiber Bending Radius	25	mm
Fiber Length	1 000 MIN.	mm

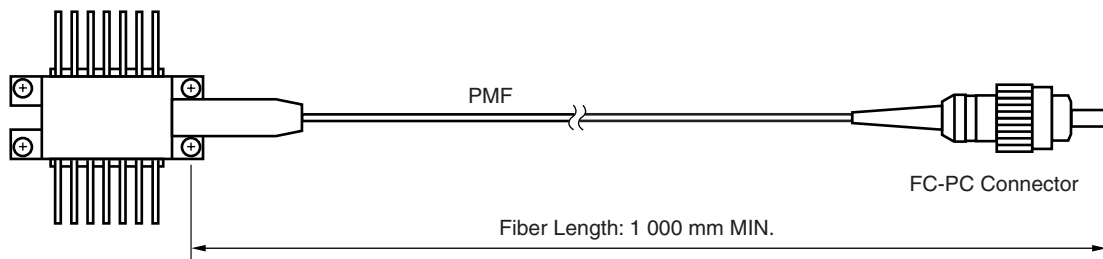

ABSOLUTE MAXIMUM RATINGS

Parameter	Symbol	Ratings	Unit
Forward Current of LD	I_F	300	mA
Reverse Voltage of LD	V_R	2.0	V
Forward Current of PD	I_F	10	mA
Reverse Voltage of PD	V_R	20	V
Operating Case Temperature	T_C	-20 to +70	°C
Storage Temperature	T_{stg}	-40 to +85	°C
Lead Soldering Temperature	T_{sld}	260 (10 sec.)	°C

ELECTRO-OPTICAL CHARACTERISTICS ($T_{LD} = T_{set}$, $T_C = -5$ to $+70^\circ\text{C}$, unless otherwise specified)

Parameter	Symbol	Conditions	MIN.	TYP.	MAX.	Unit
Laser Set Temperature	T_{set}	Single channel	20		35	°C
		4 channel tunable	10		45	
Forward Voltage	V_F	$P_f = 10$ mW	0.9	1.2	2.5	V
Threshold Current	I_{th}			20	40	mA
Operation Current	I_{op}	$P_f = 10$ mW		70	125	mA
Optical Output Power from Fiber	P_f	$I_f = 125$ mA, $T_{LD} = T_{set}$	10			mW
Peak Emission Wavelength	λ_p	$P_f = 10$ mW, CW, $T_{LD} = T_{set}$	1 530	ITU-T ^{*1}	1 609	nm
Wavelength Stability	—	$T_{LD} = T_{set}$, applicable to wavelength monitor, E.O.L	-20		+20	pm
Spectral Line Width	$\Delta\nu$	$P_f = 10$ mW, CW, 3 dB down		1	2	MHz
Side Mode Suppression Ratio	SMSR	$P_f = 10$ mW, CW	35	45		dB
Relative Intensity Noise	RIN	$P_f = 10$ mW, 20 MHz to 3 GHz			-150	dB/Hz
Optical Isolation	I_s	$P_f = 10$ mW, CW	30			dB
Polarization Extinction Ratio ^{*2}	ext	$P_f = 10$ mW, CW	20			dB

*1 Available for DWDM wavelengths based on ITU-T recommendations (50 GHz grid, please refer to the **ORDERING INFORMATION**)

*2 Polarization state of LD is aligned parallel to the slow axis.

ELECTRO-OPTICAL CHARACTERISTICS (Applicable to Monitor PD: $T_{LD} = T_{set}$, $T_c = -5$ to $+70^\circ\text{C}$)

Parameter	Symbol	Conditions	MIN.	TYP.	MAX.	Unit
Monitor Current (P_f Monitor)	$I_m (P_f)$	$P_f = 10 \text{ mW}$, $V_R = 5 \text{ V}$	20		200	μA
Monitor Current (λ_p Monitor)	$I_m (\lambda_p)$	$P_f = 10 \text{ mW}$, $V_R = 5 \text{ V}$, Locking point	10		100	μA
Operation Region ^{*1}	$I_m (\lambda)$		25		75	%
	$ \lambda_1 - \lambda_2 $		90			pm
Discrimination Slope ^{**}	η_λ		0.05			$\mu\text{A/pm}$
Dark Current	I_D	$V_R = 5 \text{ V}$		2	10	nA
Tracking Error	γ^2	$I_m = \text{const.}$			0.5	dB

*1 Operation region, Discrimination slope, Slope assignment

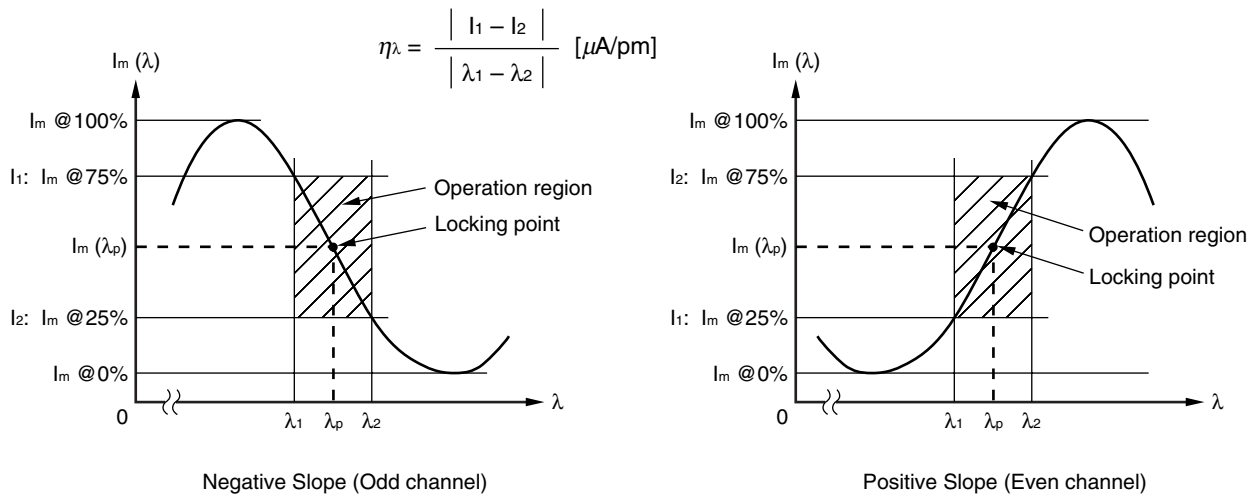

*2 Tracking Error: γ

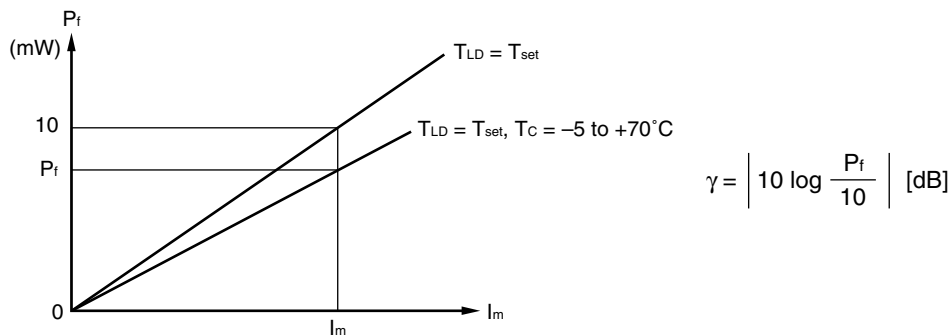

ELECTRO-OPTICAL CHARACTERISTICS (Applicable to Thermistor and TEC: $T_{LD} = T_{set}$, $T_c = -5$ to $+70^\circ\text{C}$)

Parameter	Symbol	Conditions	MIN.	TYP.	MAX.	Unit
Thermistor Resistance	R	$T_{LD} = 25^\circ\text{C}$	9.5	10.0	10.5	k Ω
B Constant	B	$T_{LD} = 25^\circ\text{C}$	3 350	3 450	3 550	K
Cooler Current	I_c	$\Delta T = 70 - T_{set}$, $P_f = 10 \text{ mW}$			1.5	A
Cooler Voltage	V_c	$\Delta T = 70 - T_{set}$, $P_f = 10 \text{ mW}$			3.0	V

ORDERING INFORMATION

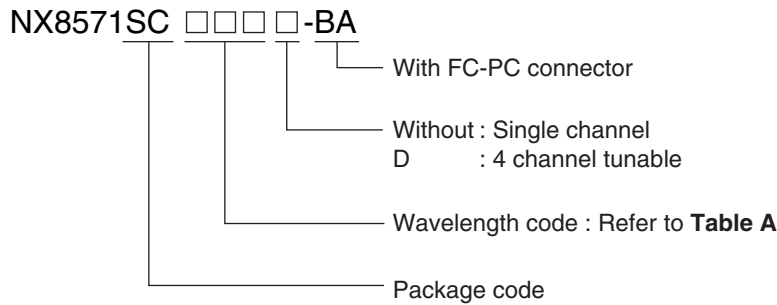

Table A: DWDM wavelength base on ITU-T recommendations (@ T_{LD} = T_{set}) (1/7)

Wavelength Code		ITU-T Wavelength *1 (nm)	Frequency (THz)	Monitor Slope
4 channel tunable	single channel			
315D	303	1 530.33	195.90	Negative
	307	1 530.72	195.85	Positive
	311	1 531.11	195.80	Negative
	315	1 531.50	195.75	Positive
330D	318	1 531.89	195.70	Negative
	322	1 532.29	195.65	Positive
	326	1 532.68	195.60	Negative
	330	1 533.07	195.55	Positive
346D	334	1 533.46	195.50	Negative
	338	1 533.85	195.45	Positive
	342	1 534.25	195.40	Negative
	346	1 534.64	195.35	Positive
362D	350	1 535.03	195.30	Negative
	354	1 535.42	195.25	Positive
	358	1 535.82	195.20	Negative
	362	1 536.21	195.15	Positive
377D	366	1 536.60	195.10	Negative
	370	1 537.00	195.05	Positive
	373	1 537.39	195.00	Negative
	377	1 537.79	194.95	Positive
393D	381	1 538.18	194.90	Negative
	385	1 538.58	194.85	Positive
	389	1 538.97	194.80	Negative
	393	1 539.37	194.75	Positive

*1 The value which omitted and computed the 3rd place below the decimal point

Table A: DWDM wavelength base on ITU-T recommendations (@ T_{LD} = T_{set}) (2/7)

Wavelength Code		ITU-T Wavelength *1 (nm)	Frequency (THz)	Monitor Slope
4 channel tunable	single channel			
409D	397	1 539.76	194.70	Negative
	401	1 540.16	194.65	Positive
	405	1 540.55	194.60	Negative
	409	1 540.95	194.55	Positive
425D	413	1 541.34	194.50	Negative
	417	1 541.74	194.45	Positive
	421	1 542.14	194.40	Negative
	425	1 542.53	194.35	Positive
441D	429	1 542.93	194.30	Negative
	433	1 543.33	194.25	Positive
	437	1 543.73	194.20	Negative
	441	1 544.12	194.15	Positive
457D	445	1 544.52	194.10	Negative
	449	1 544.92	194.05	Positive
	453	1 545.32	194.00	Negative
	457	1 545.72	193.95	Positive
473D	461	1 546.11	193.90	Negative
	465	1 546.51	193.85	Positive
	469	1 546.91	193.80	Negative
	473	1 547.31	193.75	Positive
489D	477	1 547.71	193.70	Negative
	481	1 548.11	193.65	Positive
	485	1 548.51	193.60	Negative
	489	1 548.91	193.55	Positive
505D	493	1 549.31	193.50	Negative
	497	1 549.71	193.45	Positive
	501	1 550.11	193.40	Negative
	505	1 550.51	193.35	Positive
521D	509	1 550.91	193.30	Negative
	513	1 551.31	193.25	Positive
	517	1 551.72	193.20	Negative
	521	1 552.12	193.15	Positive

*1 The value which omitted and computed the 3rd place below the decimal point

Table A: DWDM wavelength base on ITU-T recommendations (@ T_{LD} = T_{set}) (3/7)

Wavelength Code		ITU-T Wavelength *1 (nm)	Frequency (THz)	Monitor Slope
4 channel tunable	single channel			
537D	525	1 552.52	193.10	Negative
	529	1 552.92	193.05	Positive
	533	1 553.32	193.00	Negative
	537	1 553.73	192.95	Positive
553D	541	1 554.13	192.90	Negative
	545	1 554.53	192.85	Positive
	549	1 554.94	192.80	Negative
	553	1 555.34	192.75	Positive
569D	557	1 555.74	192.70	Negative
	561	1 556.15	192.65	Positive
	565	1 556.55	192.60	Negative
	569	1 556.95	192.55	Positive
585D	573	1 557.36	192.50	Negative
	577	1 557.76	192.45	Positive
	581	1 558.17	192.40	Negative
	585	1 558.57	192.35	Positive
602D	589	1 558.98	192.30	Negative
	593	1 559.38	192.25	Positive
	597	1 559.79	192.20	Negative
	602	1 560.20	192.15	Positive
618D	606	1 560.60	192.10	Negative
	610	1 561.01	192.05	Positive
	614	1 561.41	192.00	Negative
	618	1 561.82	191.95	Positive
634D	622	1 562.23	191.90	Negative
	626	1 562.64	191.85	Positive
	630	1 563.04	191.80	Negative
	634	1 563.45	191.75	Positive
650D	638	1 563.86	191.70	Negative
	642	1 564.27	191.65	Positive
	646	1 564.67	191.60	Negative
	650	1 565.08	191.55	Positive

*1 The value which omitted and computed the 3rd place below the decimal point

Table A: DWDM wavelength base on ITU-T recommendations (@ T_{LD} = T_{set}) (4/7)

Wavelength Code		ITU-T Wavelength *1 (nm)	Frequency (THz)	Monitor Slope
4 channel tunable	single channel			
667D	654	1 565.49	191.50	Negative
	659	1 565.90	191.45	Positive
	663	1 566.31	191.40	Negative
	667	1 566.72	191.35	Positive
683D	671	1 567.13	191.30	Negative
	675	1 567.54	191.25	Positive
	679	1 567.95	191.20	Negative
	683	1 568.36	191.15	Positive
700D	687	1 568.77	191.10	Negative
	691	1 569.18	191.05	Positive
	695	1 569.59	191.00	Negative
	700	1 570.00	190.95	Positive
716D	704	1 570.41	190.90	Negative
	708	1 570.82	190.85	Positive
	712	1 571.23	190.80	Negative
	716	1 571.65	190.75	Positive
733D	720	1 572.06	190.70	Negative
	724	1 572.47	190.65	Positive
	728	1 572.88	190.60	Negative
	733	1 573.30	190.55	Positive
749D	737	1 573.71	190.50	Negative
	741	1 574.12	190.45	Positive
	745	1 574.54	190.40	Negative
	749	1 574.95	190.35	Positive
766D	753	1 575.36	190.30	Negative
	757	1 575.78	190.25	Positive
	761	1 576.19	190.20	Negative
	766	1 576.61	190.15	Positive
782D	770	1 577.02	190.10	Negative
	774	1 577.44	190.05	Positive
	778	1 577.85	190.00	Negative
	782	1 578.27	189.95	Positive

*1 The value which omitted and computed the 3rd place below the decimal point

Table A: DWDM wavelength base on ITU-T recommendations (@ T_{LD} = T_{set}) (5/7)

Wavelength Code		ITU-T Wavelength *1 (nm)	Frequency (THz)	Monitor Slope
4 channel tunable	single channel			
799D	786	1 578.68	189.90	Negative
	791	1 579.10	189.85	Positive
	795	1 579.51	189.80	Negative
	799	1 579.93	189.75	Positive
816D	803	1 580.35	189.70	Negative
	807	1 580.76	189.65	Positive
	811	1 581.18	189.60	Negative
	816	1 581.60	189.55	Positive
832D	820	1 582.01	189.50	Negative
	824	1 582.43	189.45	Positive
	828	1 582.85	189.40	Negative
	832	1 583.27	189.35	Positive
849D	836	1 583.69	189.30	Negative
	841	1 584.10	189.25	Positive
	845	1 584.52	189.20	Negative
	849	1 584.94	189.15	Positive
866D	853	1 585.36	189.10	Negative
	857	1 585.78	189.05	Positive
	862	1 586.20	189.00	Negative
	866	1 586.62	188.95	Positive
883D	870	1 587.04	188.90	Negative
	874	1 587.46	188.85	Positive
	878	1 587.88	188.80	Negative
	883	1 588.30	188.75	Positive
899D	887	1 588.72	188.70	Negative
	891	1 589.14	188.65	Positive
	895	1 589.56	188.60	Negative
	899	1 589.98	188.55	Positive
916D	904	1 590.41	188.50	Negative
	908	1 590.83	188.45	Positive
	912	1 591.25	188.40	Negative
	916	1 591.67	188.35	Positive

*1 The value which omitted and computed the 3rd place below the decimal point

Table A: DWDM wavelength base on ITU-T recommendations (@ T_{LD} = T_{set}) (6/7)

Wavelength Code		ITU-T Wavelength *1 (nm)	Frequency (THz)	Monitor Slope
4 channel tunable	single channel			
933D	921	1 592.10	188.30	Negative
	925	1 592.52	188.25	Positive
	929	1 592.94	188.20	Negative
	933	1 593.36	188.15	Positive
950D	937	1 593.79	188.10	Negative
	942	1 594.21	188.05	Positive
	946	1 594.64	188.00	Negative
	950	1 595.06	187.95	Positive
967D	954	1 595.48	187.90	Negative
	959	1 595.91	187.85	Positive
	963	1 596.33	187.80	Negative
	967	1 596.76	187.75	Positive
984D	971	1 597.18	187.70	Negative
	976	1 597.61	187.65	Positive
	980	1 598.04	187.60	Negative
	984	1 598.46	187.55	Positive
6001D	988	1 598.89	187.50	Negative
	993	1 599.32	187.45	Positive
	997	1 599.74	187.40	Negative
	6001	1 600.17	187.35	Positive
6018D	6006	1 600.60	187.30	Negative
	6010	1 601.02	187.25	Positive
	6014	1 601.45	187.20	Negative
	6018	1 601.88	187.15	Positive
6035D	6023	1 602.31	187.10	Negative
	6027	1 602.74	187.05	Positive
	6031	1 603.16	187.00	Negative
	6035	1 603.59	186.95	Positive
6053D	6040	1 604.02	186.90	Negative
	6044	1 604.45	186.85	Positive
	6048	1 604.88	186.80	Negative
	6053	1 605.31	186.75	Positive

*1 The value which omitted and computed the 3rd place below the decimal point

Table A: DWDM wavelength base on ITU-T recommendations (@ T_{LD} = T_{set}) (7/7)

Wavelength Code		ITU-T Wavelength *1 (nm)	Frequency (THz)	Monitor Slope
4 channel tunable	single channel			
6070D	6057	1 605.74	186.70	Negative
	6061	1 606.17	186.65	Positive
	6066	1 606.60	186.60	Negative
	6070	1 607.03	186.55	Positive
6087D	6074	1 607.46	186.50	Negative
	6078	1 607.89	186.45	Positive
	6083	1 608.32	186.40	Negative
	6087	1 608.76	186.35	Positive

*1 The value which omitted and computed the 3rd place below the decimal point

TYPICAL CHARACTERISTICS (T_{LD} = 25°C, unless otherwise specified)

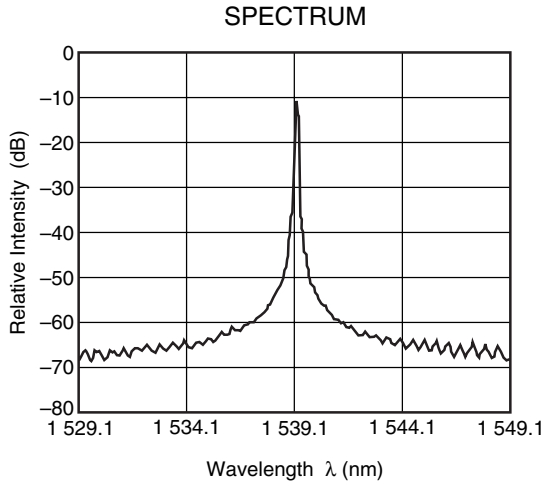

OPTICAL OUTPUT POWER FROM FIBER, MONITOR CURRENT (P_f MONITOR) vs. FORWARD CURRENT

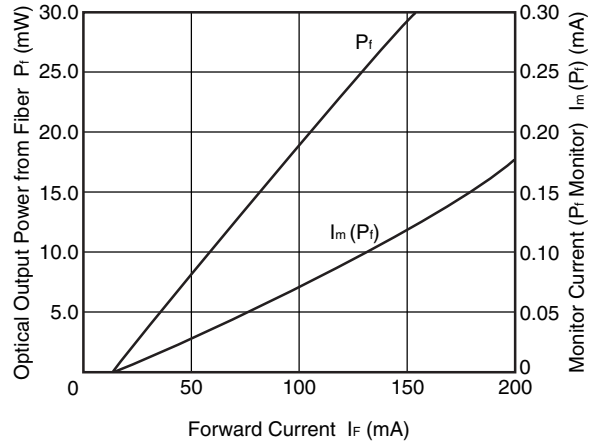

THERMISTOR RESISTANCE vs. AMBIENT TEMPERATURE

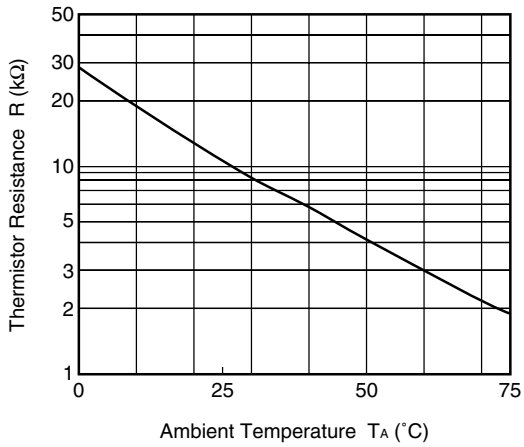

COOLER ELECTRIC POWER CONSUMPTION vs. LASER SET TEMPERATURE

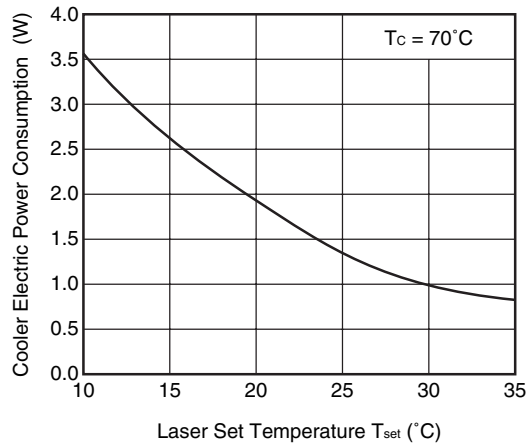

Remark The graphs indicate nominal characteristics.

REFERENCE

Document Name	Document No.
OPTICAL SEMICONDUCTOR DEVICES FOR FIBEROPTIC COMMUNICATIONS SELECTION GUIDE	PL10161E
Opto-Electronics Devices Pamphlet	PX10160E

When the product(s) listed in this document is subject to any applicable import or export control laws and regulation of the authority having competent jurisdiction, such product(s) shall not be imported or exported without obtaining the import or export license.

- **The information in this document is current as of September, 2005. The information is subject to change without notice. For actual design-in, refer to the latest publications of NEC's data sheets or data books, etc., for the most up-to-date specifications of NEC semiconductor products. Not all products and/or types are available in every country. Please check with an NEC sales representative for availability and additional information.**
 - No part of this document may be copied or reproduced in any form or by any means without prior written consent of NEC. NEC assumes no responsibility for any errors that may appear in this document.
 - NEC does not assume any liability for infringement of patents, copyrights or other intellectual property rights of third parties by or arising from the use of NEC semiconductor products listed in this document or any other liability arising from the use of such products. No license, express, implied or otherwise, is granted under any patents, copyrights or other intellectual property rights of NEC or others.
 - Descriptions of circuits, software and other related information in this document are provided for illustrative purposes in semiconductor product operation and application examples. The incorporation of these circuits, software and information in the design of customer's equipment shall be done under the full responsibility of customer. NEC assumes no responsibility for any losses incurred by customers or third parties arising from the use of these circuits, software and information.
 - While NEC endeavours to enhance the quality, reliability and safety of NEC semiconductor products, customers agree and acknowledge that the possibility of defects thereof cannot be eliminated entirely. To minimize risks of damage to property or injury (including death) to persons arising from defects in NEC semiconductor products, customers must incorporate sufficient safety measures in their design, such as redundancy, fire-containment, and anti-failure features.
 - NEC semiconductor products are classified into the following three quality grades:
 "Standard", "Special" and "Specific". The "Specific" quality grade applies only to semiconductor products developed based on a customer-designated "quality assurance program" for a specific application. The recommended applications of a semiconductor product depend on its quality grade, as indicated below. Customers must check the quality grade of each semiconductor product before using it in a particular application.
 "Standard": Computers, office equipment, communications equipment, test and measurement equipment, audio and visual equipment, home electronic appliances, machine tools, personal electronic equipment and industrial robots
 "Special": Transportation equipment (automobiles, trains, ships, etc.), traffic control systems, anti-disaster systems, anti-crime systems, safety equipment and medical equipment (not specifically designed for life support)
 "Specific": Aircraft, aerospace equipment, submersible repeaters, nuclear reactor control systems, life support systems and medical equipment for life support, etc.
- The quality grade of NEC semiconductor products is "Standard" unless otherwise expressly specified in NEC's data sheets or data books, etc. If customers wish to use NEC semiconductor products in applications not intended by NEC, they must contact an NEC sales representative in advance to determine NEC's willingness to support a given application.
- (Note)
- (1) "NEC" as used in this statement means NEC Corporation, NEC Compound Semiconductor Devices, Ltd. and also includes its majority-owned subsidiaries.
 - (2) "NEC semiconductor products" means any semiconductor product developed or manufactured by or for NEC (as defined above).

M8E 00.4-0110

SAFETY INFORMATION ON THIS PRODUCT

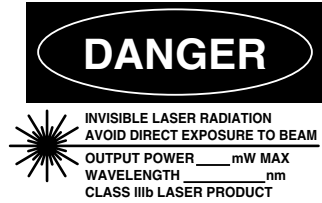

SEMICONDUCTOR LASER

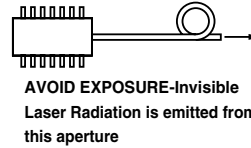

<p>Warning Laser Beam</p>	<p>A laser beam is emitted from this diode during operation. The laser beam, visible or invisible, directly or indirectly, may cause injury to the eye or loss of eyesight.</p> <ul style="list-style-type: none"> Do not look directly into the laser beam. Avoid exposure to the laser beam, any reflected or collimated beam.
<p>Caution GaAs Products</p>	<p>This product uses gallium arsenide (GaAs). GaAs vapor and powder are hazardous to human health if inhaled or ingested, so please observe the following points.</p> <ul style="list-style-type: none"> Follow related laws and ordinances when disposing of the product. If there are no applicable laws and/or ordinances, dispose of the product as recommended below. <ol style="list-style-type: none"> Commission a disposal company able to (with a license to) collect, transport and dispose of materials that contain arsenic and other such industrial waste materials. Exclude the product from general industrial waste and household garbage, and ensure that the product is controlled (as industrial waste subject to special control) up until final disposal. Do not burn, destroy, cut, crush, or chemically dissolve the product. Do not lick the product or in any way allow it to enter the mouth.
<p>Caution Optical Fiber</p>	<p>A glass-fiber is attached on the product. Handle with care.</p> <ul style="list-style-type: none"> When the fiber is broken or damaged, handle carefully to avoid injury from the damaged part or fragments.

► For further information, please contact

NEC Compound Semiconductor Devices, Ltd. <http://www.ncsd.necel.com/>
 E-mail: salesinfo@ml.ncsd.necel.com (sales and general)
 techinfo@ml.ncsd.necel.com (technical)
 Sales Division TEL: +81-44-435-1573 FAX: +81-44-435-1579

NEC Compound Semiconductor Devices Hong Kong Limited
 E-mail: ncsd-hk@elhk.nec.com.hk (sales, technical and general)
 Hong Kong Head Office TEL: +852-3107-7303 FAX: +852-3107-7309
 Taipei Branch Office TEL: +886-2-8712-0478 FAX: +886-2-2545-3859
 Korea Branch Office TEL: +82-2-558-2120 FAX: +82-2-558-5209

NEC Electronics (Europe) GmbH <http://www.ee.nec.de/>
 TEL: +49-211-6503-0 FAX: +49-211-6503-1327

California Eastern Laboratories, Inc. <http://www.cel.com/>
 TEL: +1-408-988-3500 FAX: +1-408-988-0279