

EMSL12L2H-120.000M TR

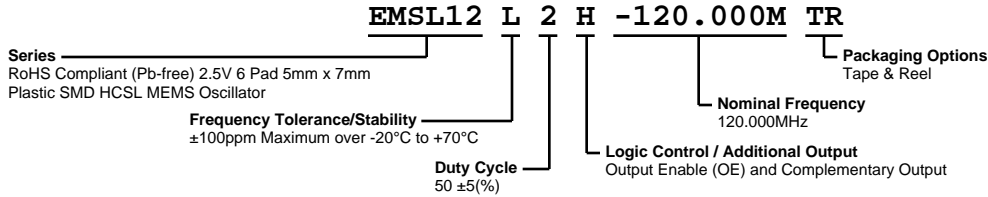

ELECTRICAL SPECIFICATIONS

| | |
|--|---|
| Nominal Frequency | 120.000MHz |
| Frequency Tolerance/Stability | ± 100 ppm Maximum over -20°C to $+70^{\circ}\text{C}$ (Inclusive of all conditions: Calibration Tolerance at 25°C , Frequency Stability over the Operating Temperature Range, Supply Voltage Change, Output Load Change, 1st Year Aging at 25°C , Reflow, Shock, and Vibration) |
| Aging at 25°C | ± 1 ppm First Year Maximum |
| Supply Voltage | +2.5Vdc ± 0.125 Vdc |
| Input Current | 65mA Maximum (Excluding Load Termination Current) |
| Output Voltage Logic High (Voh) | 750mVdc Typical, 600mVdc Minimum |
| Output Voltage Logic Low (Vol) | 25mVdc Typical, 50mVdc Maximum |
| Rise/Fall Time | 300pSec Typical, 350pSec Maximum (Measured over 20% to 80% of waveform) |
| Duty Cycle | 50 ± 5 (%) (Measured at 50% of waveform) |
| Load Drive Capability | 50 Ohms to ground (Output and Complementary Output) |
| Output Logic Type | HCSSL |
| Logic Control / Additional Output | Output Enable (OE) and Complementary Output |
| Output Control Input Voltage | Vih of 70% of Vcc Minimum or No Connect to Enable Output and Complementary Output, Vil of 30% of Vcc Maximum to Disable Output and Complementary Output (High Impedance) |
| Output Enable Current | 60mA Maximum (OE) Without Load |
| Period Jitter (Deterministic) | 0.2pSec Typical |
| Period Jitter (Random) | 2.0pSec Typical |
| Period Jitter (RMS) | 1.5pSec Typical, 3.0pSec Maximum |
| Period Jitter (pk-pk) | 20pSec Typical, 25pSec Maximum |
| Period Jitter (Cycle to Cycle) | 10pSec Typical |
| RMS Phase Jitter (Fj = 637kHz to 10MHz; Random) | 1.6pSec Typical |
| RMS Phase Jitter (Fj = 1.5MHz to 22MHz; Random) | 0.6pSec Typical |
| RMS Phase Jitter (Fj = 1.875MHz to 20MHz; Random) | 0.5pSec Typical |
| Start Up Time | 10mSec Maximum |
| Storage Temperature Range | -55°C to $+125^{\circ}\text{C}$ |

ENVIRONMENTAL & MECHANICAL SPECIFICATIONS

| | |
|-------------------------------------|---|
| ESD Susceptibility | MIL-STD-883, Method 3015, Class 2, HBM 2000V |
| Flammability | UL94-V0 |
| Mechanical Shock | MIL-STD-883, Method 2002, Condition G, 30,000G |
| Moisture Resistance | MIL-STD-883, Method 1004 |
| Moisture Sensitivity Level | J-STD-020, MSL 1 |
| Resistance to Soldering Heat | MIL-STD-202, Method 210, Condition K |
| Resistance to Solvents | MIL-STD-202, Method 215 |
| Solderability | MIL-STD-883, Method 2003 (Six I/O Pads on bottom of package only) |
| Temperature Cycling | MIL-STD-883, Method 1010, Condition B |
| Thermal Shock | MIL-STD-883, Method 1011, Condition B |
| Vibration | MIL-STD-883, Method 2007, Condition A, 20G |

EMSL12L2H-120.000M TR

MECHANICAL DIMENSIONS (all dimensions in millimeters)

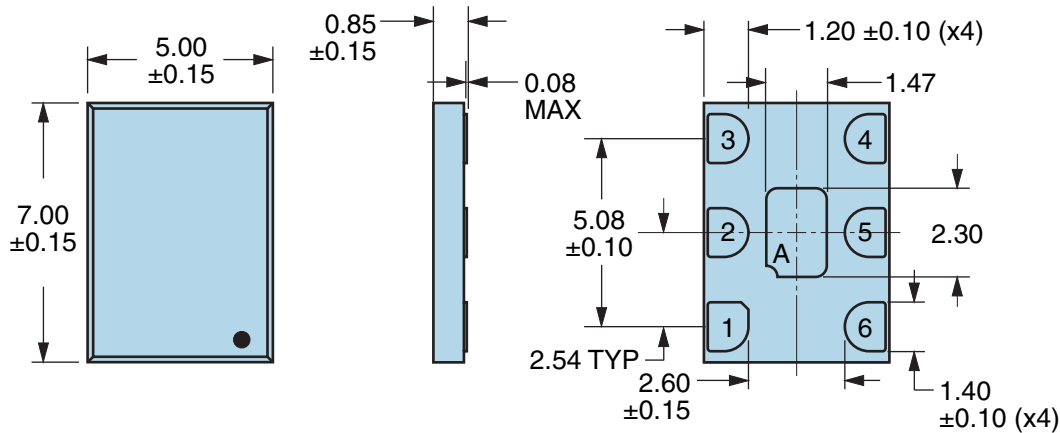

| PIN | CONNECTION |
|-----|----------------------|
| 1 | Output Enable (OE) |
| 2 | No Connect |
| 3 | Case Ground |
| 4 | Output |
| 5 | Complementary Output |
| 6 | Supply Voltage |

| LINE | MARKING |
|------|---|
| 1 | XXXX or XXXXX XXXX or XXXXX=Ecliptek Manufacturing Lot Code |

Note A: Center paddle is connected internally to oscillator ground (Pad 3).

Suggested Solder Pad Layout

All Dimensions in Millimeters

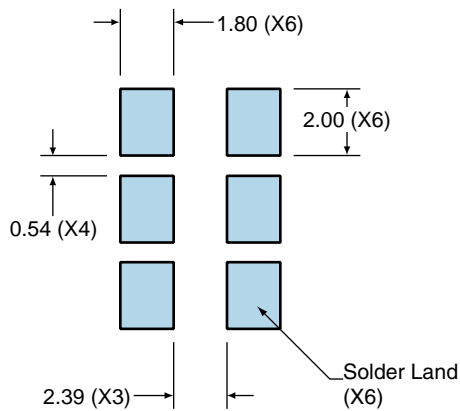

All Tolerances are ± 0.1

EMSL12L2H-120.000M TR

OUTPUT WAVEFORM & TIMING DIAGRAM

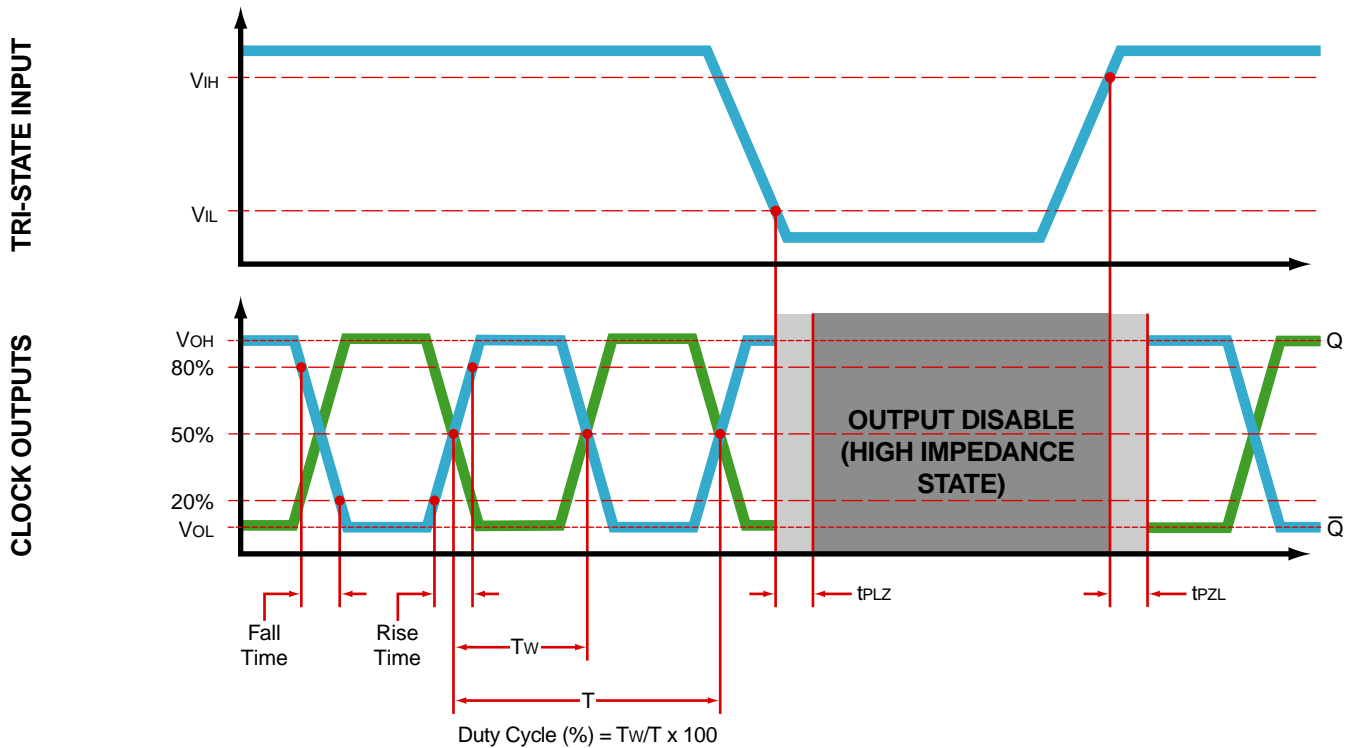

Test Circuit for Tri-State and Complementary Output

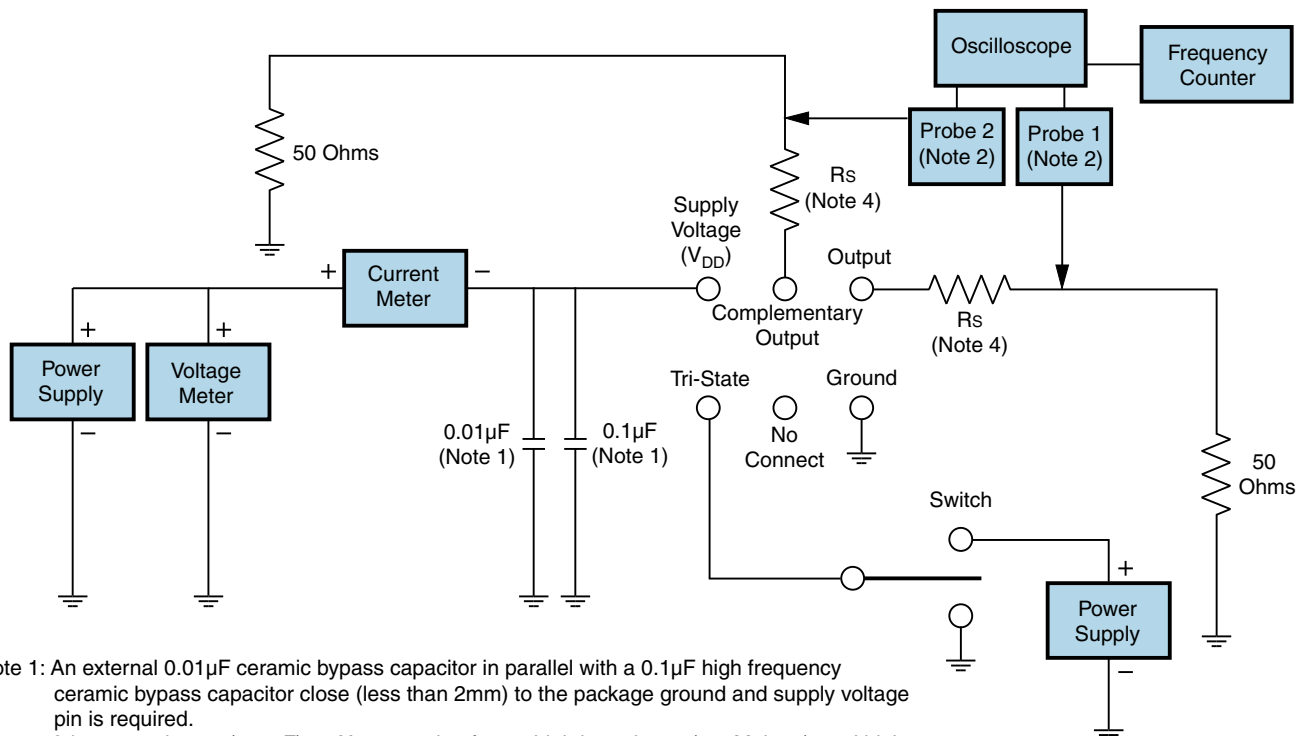

- Note 1: An external 0.01 μ F ceramic bypass capacitor in parallel with a 0.1 μ F high frequency ceramic bypass capacitor close (less than 2mm) to the package ground and supply voltage pin is required.
- Note 2: A low capacitance (<12pF), 10X attenuation factor, high impedance (>10Mohms), and high bandwidth (>500MHz) passive probe is recommended.
- Note 3: Test circuit PCB traces need to be designed for a characteristic line impedance of 50 ohms.
- Note 4: A 10 ohm to 33 ohm series resistor is required to limit overshoot. Rs value is circuit layout dependant.

EMSL12L2H-120.000M TR

Tape & Reel Dimensions

Quantity Per Reel: 1,000 units

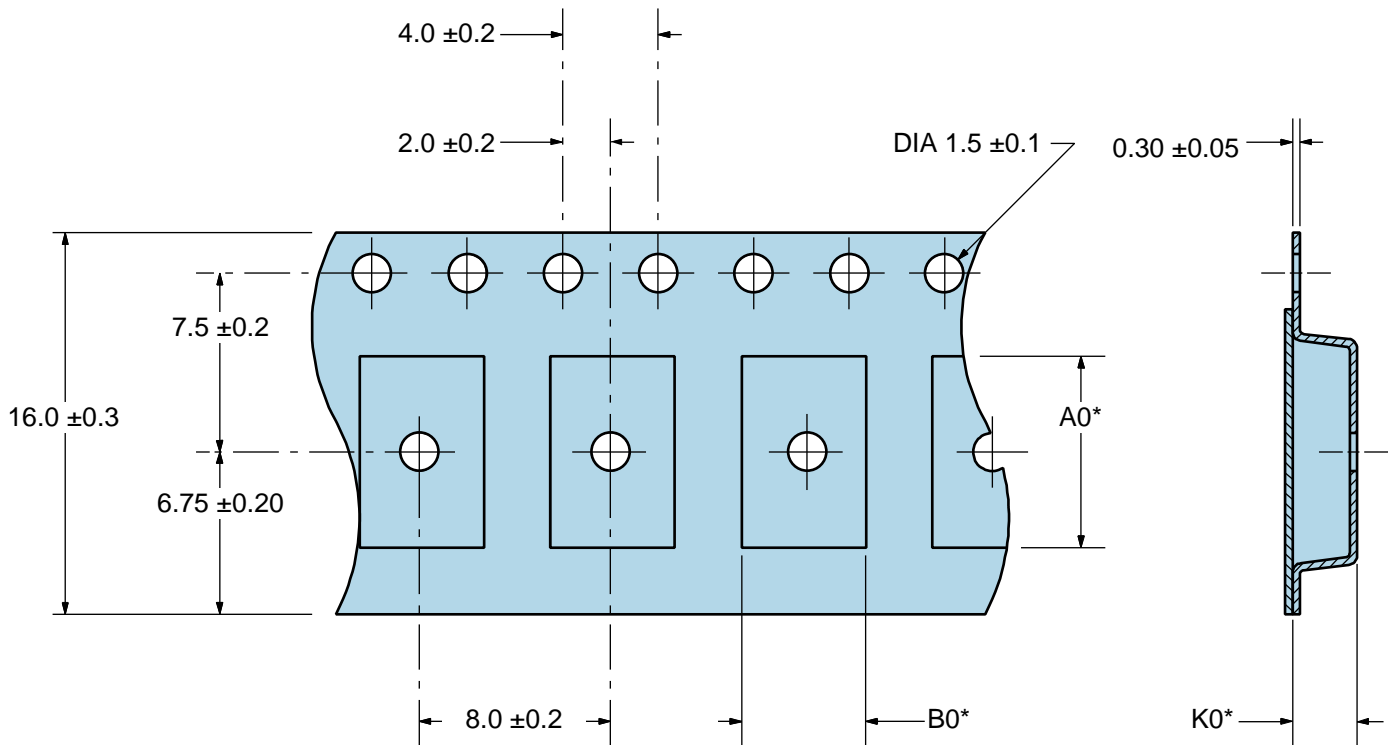

*Compliant to EIA 481A

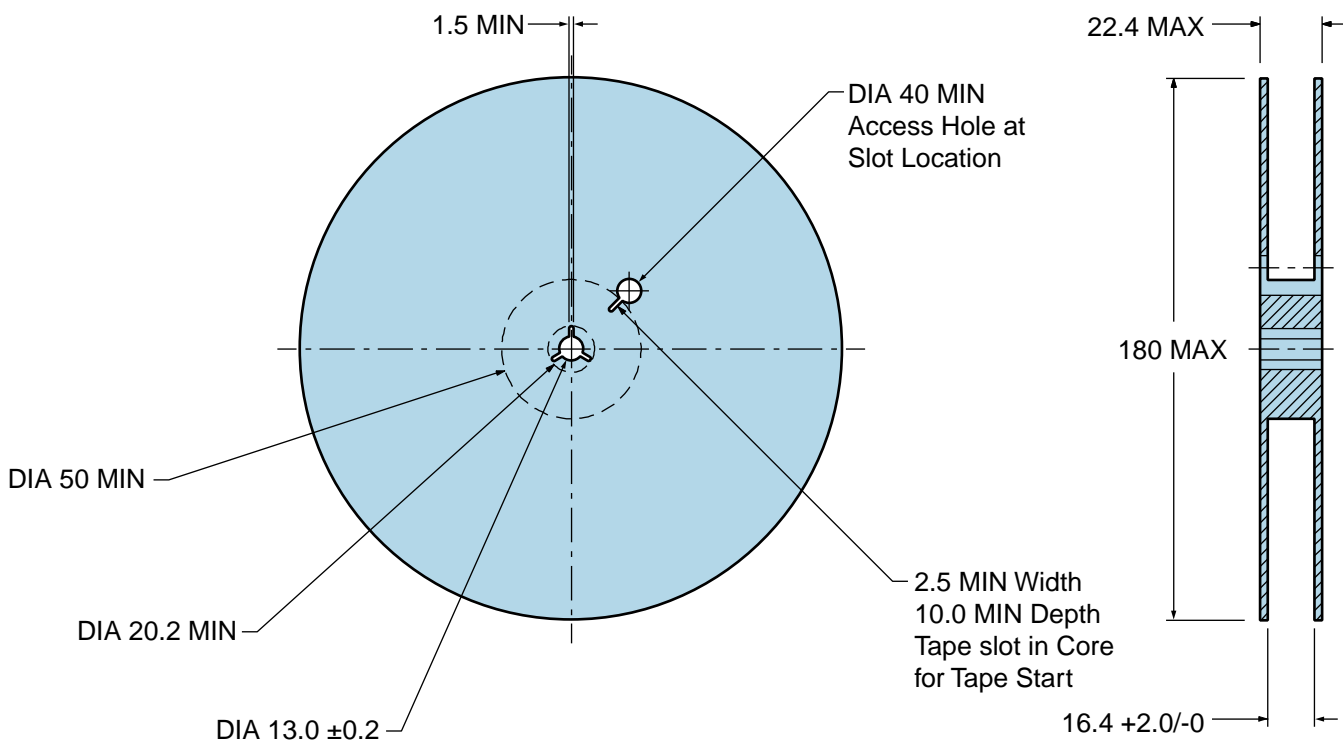

EMSL12L2H-120.000M TR



Recommended Solder Reflow Methods



High Temperature Infrared/Convection

| | |
|--|--------------------------------------|
| T_s MAX to T_L (Ramp-up Rate) | 3°C/second Maximum |
| Preheat | |
| - Temperature Minimum (T _s MIN) | 150°C |
| - Temperature Typical (T _s TYP) | 175°C |
| - Temperature Maximum (T _s MAX) | 200°C |
| - Time (t _s MIN) | 60 - 180 Seconds |
| Ramp-up Rate (T_L to T_p) | 3°C/second Maximum |
| Time Maintained Above: | |
| - Temperature (T _L) | 217°C |
| - Time (t _L) | 60 - 150 Seconds |
| Peak Temperature (T_p) | 260°C Maximum for 10 Seconds Maximum |
| Target Peak Temperature (T_p Target) | 250°C +0/-5°C |
| Time within 5°C of actual peak (t_p) | 20 - 40 seconds |
| Ramp-down Rate | 6°C/second Maximum |
| Time 25°C to Peak Temperature (t) | 8 minutes Maximum |
| Moisture Sensitivity Level | Level 1 |

EMSL12L2H-120.000M TR

Recommended Solder Reflow Methods



Low Temperature Infrared/Convection 240°C

| | |
|--|--|
| T_S MAX to T_L (Ramp-up Rate) | 5°C/second Maximum |
| Preheat | |
| - Temperature Minimum (T_S MIN) | N/A |
| - Temperature Typical (T_S TYP) | 150°C |
| - Temperature Maximum (T_S MAX) | N/A |
| - Time (t_S MIN) | 60 - 120 Seconds |
| Ramp-up Rate (T_L to T_P) | 5°C/second Maximum |
| Time Maintained Above: | |
| - Temperature (T_L) | 150°C |
| - Time (t_L) | 200 Seconds Maximum |
| Peak Temperature (T_P) | 240°C Maximum |
| Target Peak Temperature (T_P Target) | 240°C Maximum 1 Time / 230°C Maximum 2 Times |
| Time within 5°C of actual peak (t_p) | 10 seconds Maximum 2 Times / 80 seconds Maximum 1 Time |
| Ramp-down Rate | 5°C/second Maximum |
| Time 25°C to Peak Temperature (t) | N/A |
| Moisture Sensitivity Level | Level 1 |

Low Temperature Manual Soldering

185°C Maximum for 10 seconds Maximum, 2 times Maximum.

High Temperature Manual Soldering

260°C Maximum for 5 seconds Maximum, 2 times Maximum.