Solid-State Optical Mouse Sensor with PS/2 and Quadrature Outputs

Technical Data

HDNS-2000

Features

- **Optical Navigation Technology**
 - Superior precision and smooth navigation optimized for desktop and portable mouse applications
 - No moving parts, provides high reliability and needs no maintenance
- **Complete Compact 2-D Motion Sensor**
 - Easy implementation and design flexibility
 - Replaces mechanical ball system in traditional mice
- **Two Selectable Output Modes**
 - Standard 3-Button PS/2 Output Mode
 - Two Channel Quadrature Output Mode (X and Y Direction) which emulates encoder phototransistors
- **High Speed Motion Detection**
 - Accurately measures up to 12 inches per second at 400 cpi

- **Accurate Navigation over a Wide Range of Surfaces**
 - Enables mouse to be used with or without a mouse pad
- **Power Conservation Mode during No Motion**
- **Compatible with High Volume Manufacturing Processes**
 - Requires no precision optical alignment
 - Wave solderable

Applications

- **Computer Mice for Desktop PCs, Workstations and Portable Computers**
- **Integrated Input Devices**

Description

The HDNS-2000 is a low-cost reflective optical sensor that provides a non-mechanical tracking engine for implementing a computer mouse.

It is based on optical navigation technology which measures changes in position by optically acquiring sequential surface images (frames) and mathematically determining the direction



and magnitude of movement. The sensor is mounted in a plastic optical package and designed to be used with the HDNS-2100 (Lens), HDNS-2200 (LED Assembly Clip), and HLMP-ED80-XXXXX (High Light Output 639 nm LED), providing a complete and compact tracking engine. This optical tracking engine has no moving parts and requires no precision optical alignment enabling high volume system assembly. The HDNS-2000 offers a PS/2 or quadrature output mode for interface flexibility. Resolution is specified as 400 cpi at rates of motion up to 12 inches per second.

CAUTION: It is advised that normal static precautions be taken in handling and assembly of this component to prevent damage and/or degradation which may be induced by ESD.

Theory of Operation

The HDNS-2000 is based on Optical Navigation Technology. It contains an Image Acquisition System (IAS), Digital Signal Processor (DSP), and a mode selectable PS/2 or quadrature output converter. The IAS acquires images of microscopic

surface images via the lens and illumination system provided by the HDNS-2100, HDNS-2200 and the HLMP-ED80-XXXXX. These images are further processed by the DSP to determine direction and distance of motion. The DSP generates a stream of Δx and Δy relative displacement values

which are then communicated to the output converter. This converter provides a PS/2 3-Button output, replacing existing mouse microcontrollers, or two channel quadrature output, for direct interface to existing mouse microcontrollers.

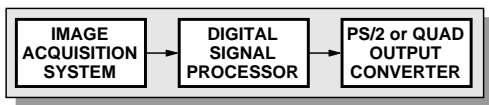

Figure 1. HDNS-2000 Block Diagram.

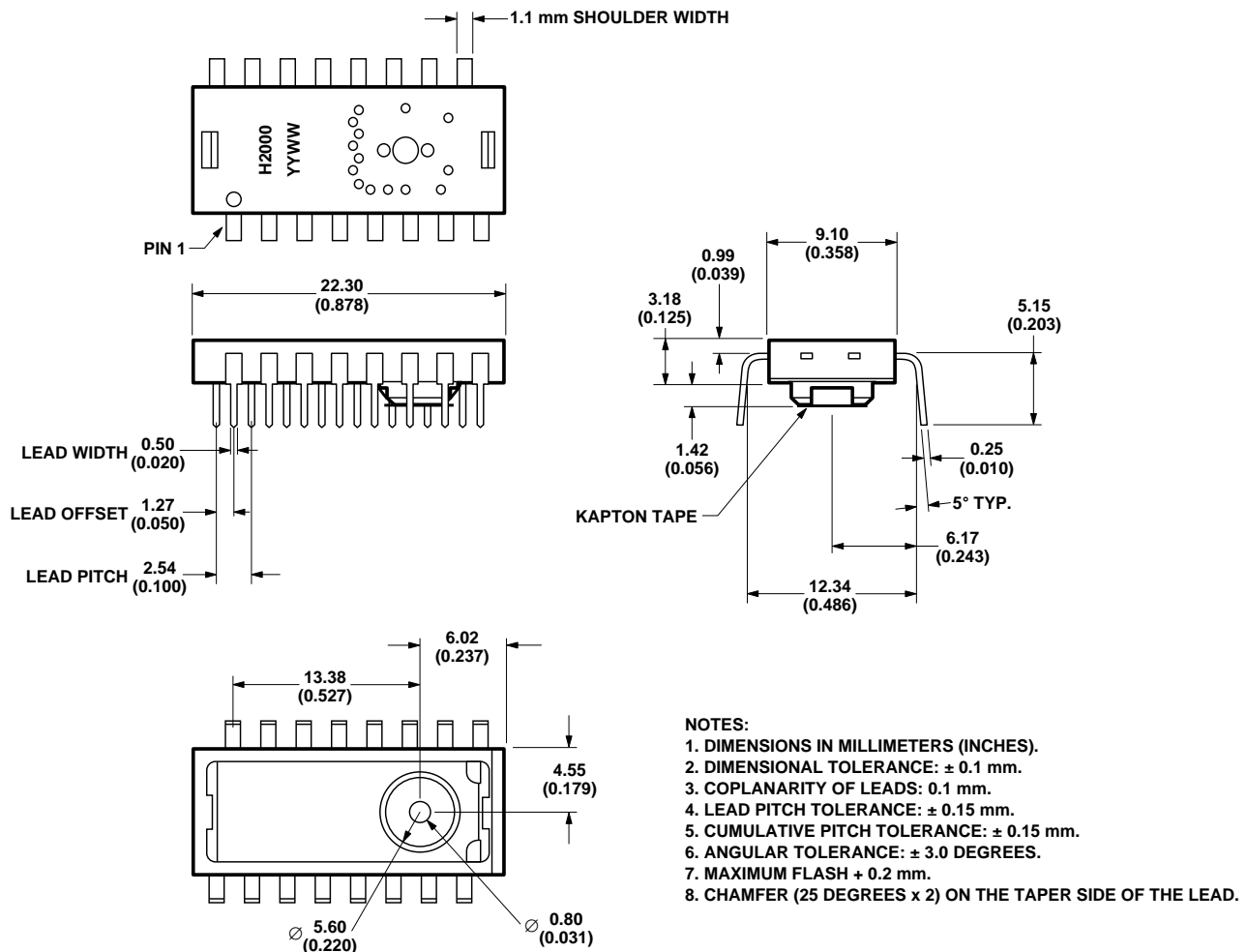

Figure 2. HDNS-2000 Sensor Package Outline Drawing.

Pinout

| Pin | Name | PS/2 mode | Quadrature mode |
|-----|------------------|----------------------|----------------------|
| 1 | PS2_C | PS/2 Interface Clock | PS/2 Interface Clock |
| 2 | MODE/XA | Select PS/2 mode | XA output |
| 3 | RB/XB | Right Button input | XB output |
| 4 | MB/YB | Middle Button input | YB output |
| 5 | LB/YA | Left Button input | YA output |
| 6 | XY_LED | LED control output | LED control output |
| 7 | V _{DD3} | 3.3 VDC input | 3.3 VDC input |
| 8 | REFB | Internal reference | Internal reference |
| 9 | OSC1 | Oscillator input | Oscillator input |
| 10 | GND | Ground | Ground |
| 11 | OSC2 | Oscillator output | Oscillator output |
| 12 | GND | Ground | Ground |
| 13 | V _{DD5} | 5 VDC input | 5 VDC input |
| 14 | V _{DD5} | 5 VDC input | 5 VDC input |
| 15 | NRESET | NRESET | NRESET |
| 16 | PS2_D | PS/2 Interface Data | PS/2 Interface Data |

2D Assembly Drawing of HDNS-2000

Shown with HDNS-2100, HDNS-2200, and HLMP-ED80-XXXXX.

Agilent provides an IGES file drawing describing the base plate molding features for lens and PCB alignment. See HDNS-2100 Technical Data Sheet for more information.

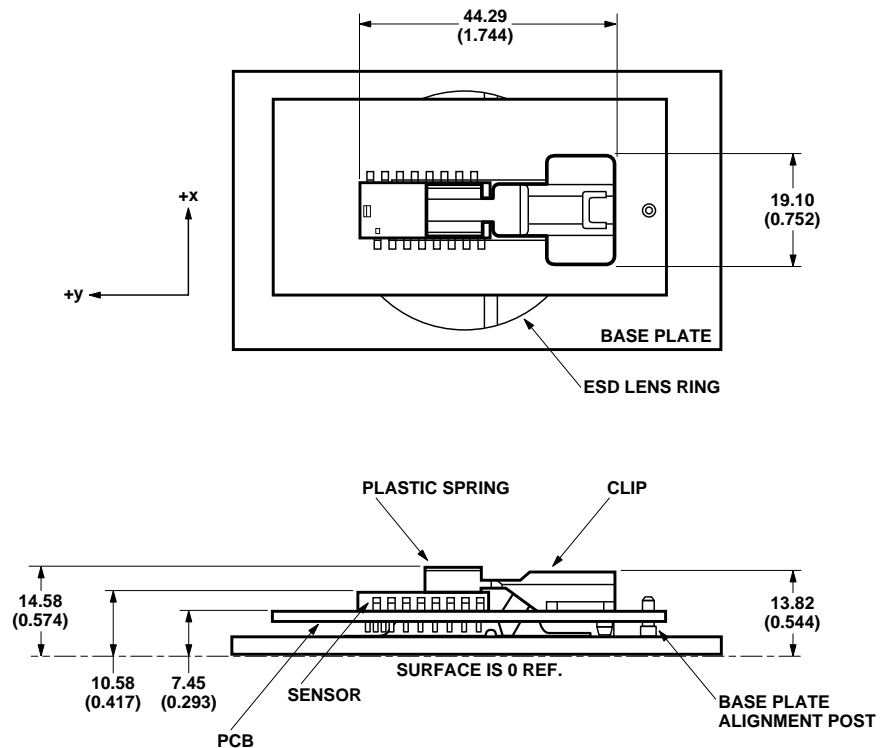

DIMENSIONS IN MILLIMETERS (INCHES)

Figure 3.

Exploded View Drawing

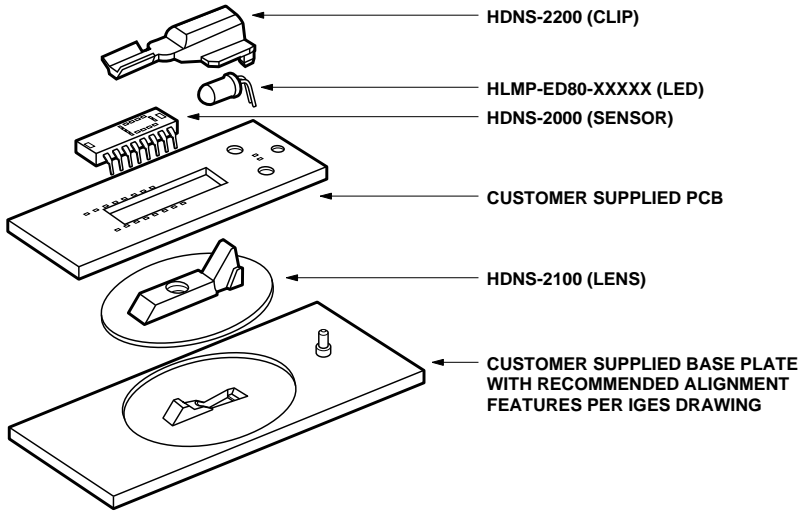
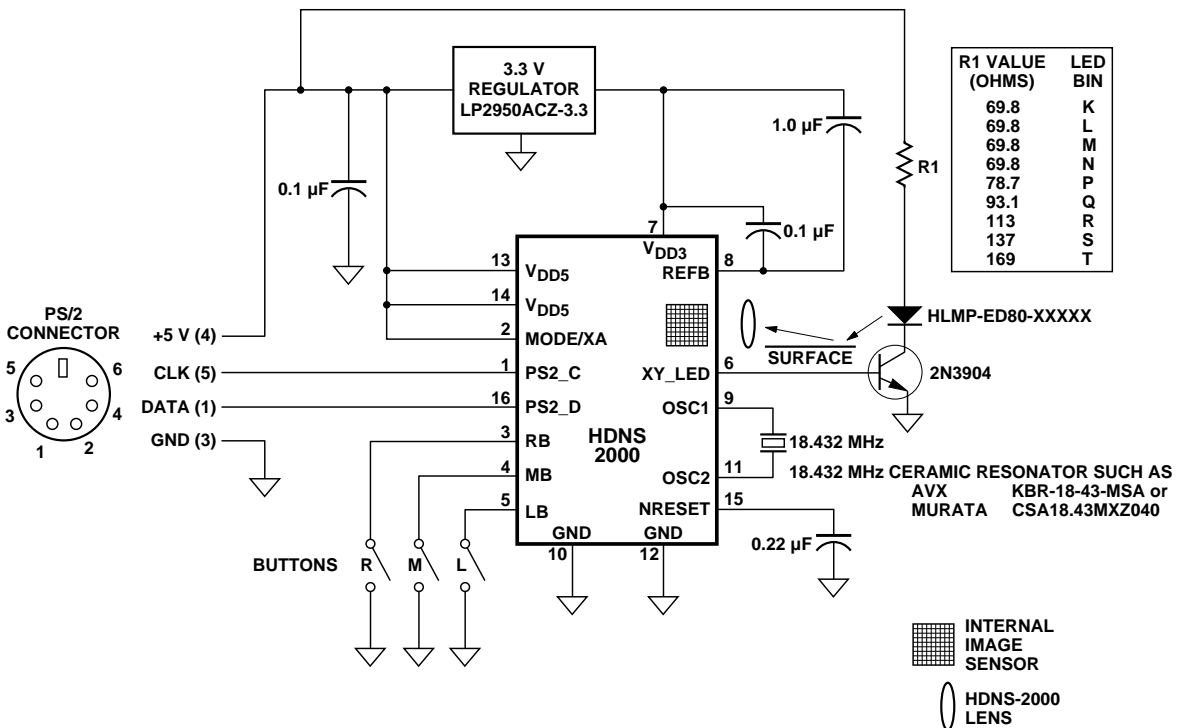

Figure 4.

Typical Application using PS/2 Output



NOTE: 0.1 μF BETWEEN PINS 7 AND 8 MUST BE CERAMIC AND MUST BE TRACE LENGTHS LESS THAN 5 mm.

Recommended Operating Conditions

| Parameter | Symbol | Min. | Typ. | Max. | Units | Notes |
|--|--------------------|-------|--------|-------|------------------|-------------------------------------|
| Operating Temperature | T _A | 0 | | 40 | C | |
| Supply Voltage | V _{DD3} | 3.15 | 3.3 | 3.45 | V | |
| Supply Voltage | V _{DD5} | 4.25 | 5.0 | 5.5 | V | |
| Clock Frequency | CLK | 17.4 | 18.432 | 18.7 | MHz | Set by ceramic resonator |
| Resonator Impedance | X _{RES} | | | 40 | Ω | |
| Reset Capacitor | C _{RESET} | 0.001 | 0.22 | 10.0 | μF | |
| Distance from lens foot reference plane to surface | A | 2.3 | 2.4 | 2.5 | mm | Dimension A on HDNS-2100 data sheet |
| Speed | S | 0 | | 12 | in/sec | |
| | | 0 | | 30 | cm/sec | |
| Acceleration | ACC | 0 | | 0.15 | g | |
| Light level onto IC | IRR _{INC} | 40 | | 25000 | mWm ² | λ = 639 nm |

DC Electrical Specifications

Electrical Characteristics over recommended operating conditions. Typical values at 25°C, V_{DD3}=3.3, V_{DD5}=5.0

| Parameter | Symbol | Min. | Typ. | Max. | Units | Notes |
|-----------------------------------|--------------------|------|------|------|-------|----------------------------|
| Supply Current (mouse moving) | I _{DD3} | | 9.3 | 15.5 | mA | |
| Supply Current (mouse moving) | I _{DD5} | | 4.7 | 9.5 | mA | Pin 6=0.6 V |
| Supply Current (mouse not moving) | I _{DD5} | | 1.9 | | mA | Pin 6=0.6 V |
| Input Low Voltage | V _{IL} | | | 0.8 | V | |
| Input High Voltage | V _{IH} | 2 | | | V | |
| Output Low Voltage (LED) | V _{OL} | | 0.3 | 0.5 | V | I _{OL} =2 mA |
| Output Low Voltage (XA,XB,YA,YB) | V _{OL} | | | 0.5 | V | I _{OL} =4 mA |
| Output High Current (XA,XB,YA,YB) | I _{OH} | 100 | 300 | 600 | μA | V _{OH} =2.1 V |
| Output High Current (LED) | I _{OHBD} | 1.5 | 3.1 | 6 | mA | V _{BE} =0.6 V |
| Input Pull-up (RB,MB,LB) | I _{PU} | 100 | 300 | 600 | μA | V _{IN} =0.8 V |
| Output Low Voltage (PS/2) | V _{OL} | | 0.41 | 0.5 | V | V _{OL} =20 mA |
| Output Pullup Current (PS/2) | I _{OH} | 300 | 625 | 1500 | μA | V _{OH} =2.0 V |
| Reset Pullup Current | I _{RESET} | 5 | 10 | 20 | μA | V _{NRESET} =2.0 V |

I/O Specifications

PS/2 Command Set Implementation

The following commands are implemented. All other commands will cause an FE (resend) response from the HDNS-2000. A second invalid command will cause an FC (error) response from the HDNS-2000.

| Mnemonic for Command | (HEX COMMAND) and Response Bytes | Mnemonics for Command and Response Bytes | Description | Valid Values and Default Value after Software or Hardware Reset |
|----------------------|----------------------------------|--|--|--|
| RESET | FF FA AA 00 | FF ACK ID DT | Soft reset ID=AA DT=0 | |
| RESEND | FE nn.. | FE nn.. | Resend last byte (i.e. ACK) or Packet | |
| SET_DFS | F6 FA | F6 ACK | Default Setting | |
| DISABLE | F5 FA | F5 ACK | Disable stream mode | {default mode} |
| ENABLE | F4 FA | F4 ACK | Enable stream mode | |
| SET_SAMPLING | F3 FA nn FA | F3 ACK nn ACK | Set sampling rate | {0A 14 28 3C 50 64 C8} 10 20 40 60 80 100 200 reports/second |
| READ_DT | F2 FA 00 | F2 ACK DT | Responds with DT=00 | |
| ECHO | EE FA | EE ACK | Echo all further commands until NO_ECHO or RESET | |
| NO_ECHO | EC FA | EC ACK | Respond to following commands normally | |
| READ_DATA | EB FA nn nn nn | EB ACK nn nn nn | Request a data packet | See IBM PS/2 Mouse Technical Reference |
| SET_STREAM | EA FA | EA ACK | Respond with data packets at the sample rate | {default mode} |
| SET_PROMPT | F0 FA | F0 ACK | Data only sent on READ_DATA | |
| STATUS | E9 FA nn nn nn | E9 ACK nn nn nn | Request status packet | See IBM PS/2 Mouse Technical Reference |
| SET_SCALE | E7 FA | E7 ACK | Pseudo Log | |
| LIN_SCALE | E6 FA | E6 ACK | Linear | {default mode} |
| SET_RES | E8 FA nn FA | E8 ACK nn ACK | Set resolution | {00 01 02 03} 2 4 8 16 Counts/mm |
| DISABLE_TEST | E8 FA AA FE | E8 ACK AA RESEND | For test purposes only | Default mode after hardware reset. |

PS/2 Mode Output Waveforms

Host Sending Data Timing Diagram

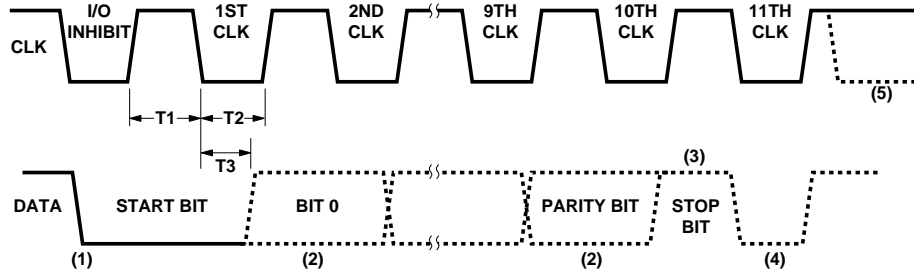

NOTES:

- 1) THE MOUSE CHECKS THE DATA LINE. IF THE LINE IS LOW, THE SYSTEM HAS DATA TO TRANSMIT. THE DATA LINE IS SET INACTIVE WHEN THE START BIT (ALWAYS 0) IS PLACED ON THE DATA LINE.
- 2) THE MOUSE SAMPLES THE DATA LINE FOR EACH BIT WHILE THE CLK LINE IS HIGH. DATA MUST BE STABLE WITHIN 1 MICROSECOND AFTER THE RISING EDGE OF THE CLK LINE.
- 3) THE MOUSE CHECKS FOR A HIGH STOP BIT AFTER THE 10TH CLK. IF THE DATA LINE IS LOW, THE MOUSE CONTINUES TO CLOCK UNTIL THE DATA LINE BECOMES HIGH, THEN CLOCKS THE LINE-CONTROL BIT, AND AT THE NEXT OPPORTUNITY SENDS A RESEND COMMAND TO THE SYSTEM.
- 4) THE MOUSE PULLS THE DATA LINE LOW, PRODUCING THE LINE-CONTROL BIT.
- 5) THE HOST CAN PULL THE CLK LINE LOW, INHIBITING THE MOUSE.

| TIMING PARAMETER | DESCRIPTION | MIN. TIME | MAX. TIME |
|------------------|--|--------------|--------------|
| T1 | DURATION OF CLK HIGH | 30 μ SEC | 50 μ SEC |
| T2 | DURATION OF CLK LOW | 30 μ SEC | 50 μ SEC |
| T3 | TIME FROM FALLING CLK TRANSITION, TO DATA TRANSITION | 0 μ SEC | 30 μ SEC |

HOST SENDING DATA TIMING

Host Receiving Data Timing Diagram

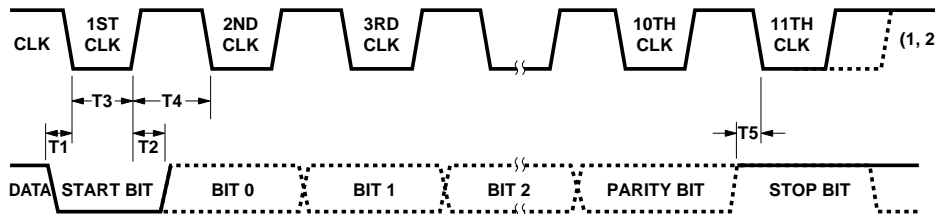

NOTES:

- 1) THE HOST CAN HOLD THE CLOCK SIGNAL LOW TO INHIBIT THE NEXT TRANSMISSION.
- 2) THE HOST RAISES THE CLOCK LINE TO ALLOW THE NEXT TRANSMISSION.
- 3) ALL TIMES GIVEN BELOW ASSUME AN 18.432 MHz RESONATOR AND ARE DEPENDENT UPON ITS ACCURACY.

| TIMING PARAMETER | DESCRIPTION | MIN. TIME | MAX. TIME |
|------------------|--|--------------|--------------|
| T1 | TIME FROM DATA TRANSITION TO FALLING EDGE OF CLK | 5 μ SEC | 25 μ SEC |
| T2 | TIME FROM RISING EDGE OF CLK TO DATA TRANSITION | 5 μ SEC | 25 μ SEC |
| T3 | DURATION OF CLK LOW | 30 μ SEC | 50 μ SEC |
| T4 | DURATION OF CLK HIGH | 30 μ SEC | 50 μ SEC |
| T5 | TIME TO MOUSE INHIBIT AFTER CLOCK 11 TO ENSURE THE MOUSE DOES NOT START ANOTHER TRANSMISSION | 0 μ SEC | 50 μ SEC |

HOST RECEIVING DATA TIMING

Quadrature Output Mode Waveform

The 2 channel quadrature outputs are 5 V CMOS outputs. The Delta X count is used to generate the XA and XB quadrature signals. The Delta Y count is used to generate the YA and YB quadrature signals. Delta X,Y counts are in the range of +7 to -7 counts of motion and new Delta X,Y values are generated at a rate of 1500 Hz. The quadrature signals can change at a maximum rate of 12.5 kHz.

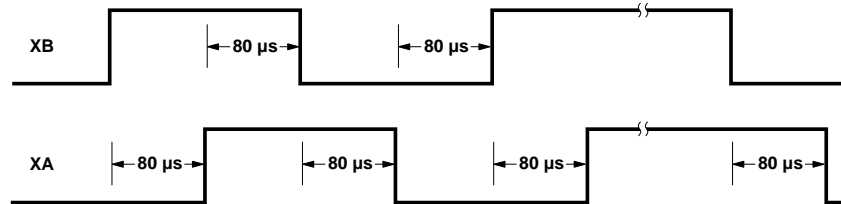

EXAMPLE QUADRATURE OUTPUT WAVEFORM (+X MOTION)

AC Electrical Specifications

Electrical characteristics over recommended operating conditions. Typical values at 25°C, $V_{DD3}=3.3$, $V_{DD5}=5.0$, $A=2.4$ mm, $CLK=18.432$ MHz

| Parameter | Symbol | Min. | Typ. | Max. | Units | Notes |
|---|--------|------|------|------|-------------|---------------------------|
| PS/2 baud rate | Fps2 | 10 | 12.5 | 15 | Kbaud | |
| PS/2 data transition delay after PS/2_C rising edge | T2 | 10 | 20 | 25 | μs | See PS/2 Timing Diagrams |
| PS/2 motion report rates | | | 100 | | reports/sec | See PS/2 command settings |
| Motion scale factor | | | 400 | | counts/inch | |
| Power up delay | | | | 100 | ms | $C_{RESET}=0.22$ μF |

Typical Performance Characteristics

Typical Performance of HDNS-2000 assembled as shown in Figure 3 with HDNS-2100 Lens, HNDS-2200 LED Assembly Clip, and HLMP-ED80-XXXXX.

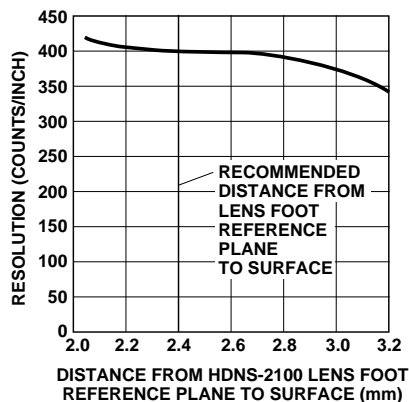

Figure 5. Typical Resolution vs. Assembly Height.

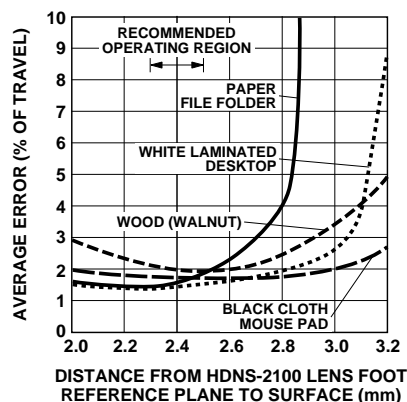

Figure 6. Typical Error vs. Assembly Height.

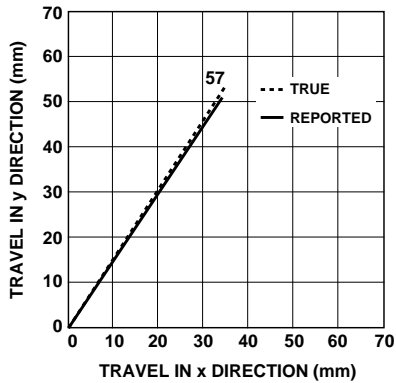

Figure 7. Typical Reported Path vs. True Path.

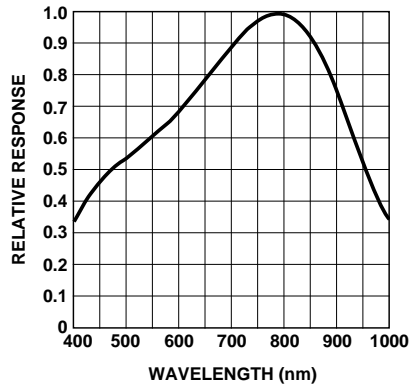

Figure 8. Typical Responsivity vs. Wavelength.

Ordering Information

Specify Part Number as follows:

- HDNS-2000 = Sensor IC in a 16-pin plastic optical package,
20 per tube, 1000 pcs in a box.
- HDNS-2100 = Optical mouse round lens.
- HDNS-2100-001 = Optical mouse trimmed lens.
- HDNS-2200 = LED assembly clip (back).
- HDNS-2200-001 = LED clip (clear).
- HDNK-2000 = Solid-state optical mouse sample kit.
- ADNB-2010 = HDNS-2000 sensor and HDNS-2100 round lens
bundle kit, 1000 pcs incremental.
- ADNB-2011 = HDNS-2000 sensor and HDNS-2100-001 trimmed
lens bundle kit, 1000 pcs incremental.
- HLMP-ED80-XXXXX = LED.

www.agilent.com/semiconductors

For product information and a complete list of distributors, please go to our web site.

For technical assistance call:

Americas/Canada: +1 (800) 235-0312 or
(408) 654-8675

Europe: +49 (0) 6441 92460

China: 10800 650 0017

Hong Kong: (+65) 6756 2394

India, Australia, New Zealand: (+65) 6755 1939

Japan: (+81 3) 3335-8152(Domestic/International),
or 0120-61-1280(Domestic Only)

Korea: (+65) 6755 1989

Singapore, Malaysia, Vietnam, Thailand,
Philippines, Indonesia: (+65) 6755 2044

Taiwan: (+65) 6755 1843

Data subject to change.

Copyright © 2003 Agilent Technologies, Inc.

Obsoletes 5988-4073EN

May 5, 2003

5988-9329EN