

7/16-3200B-1/2A

7/16 Plug Clamp

50Ω

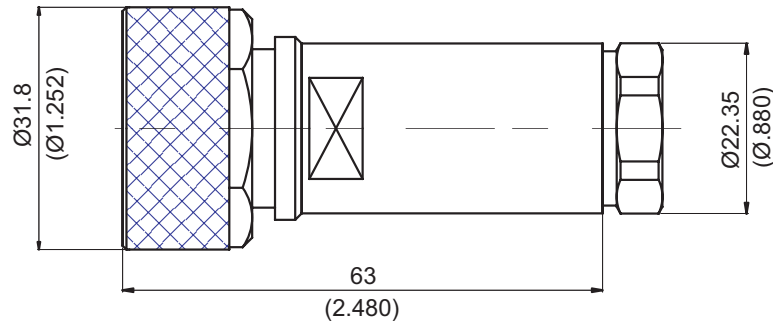

Parts	Material	Plating(Micro-inch)
Nut	Brass	Tin-Zinc-Copper-Alloy 100 Over Copper 50
Gasket	Silicon	
Contact Body	Brass	Tin-Zinc-Copper-Alloy 100 Over Copper 50
Contact Pin	Phosphor Bronze	Silver 150 Over Copper 50
Contact Pin	Brass	Silver 150 Over Copper 50
Insulator	Teflon	
Body	Brass	Tin-Zinc-Copper-Alloy 100 Over Copper 50
Coupling Nut	Brass	Tin-Zinc-Copper-Alloy 100 Over Copper 50

Weight: 145.29 g

Suitable Cables: LDF4-50A; RF1/2"BHF

**This part number complies with RoHS.**

**Notice: JYEBAO reserves the right to make modifications deemed appropriate.**

## CABLE ASSEMBLY INSTRUCTION

7/16-3200B-1/2A

JYE BAO CO., LTD.

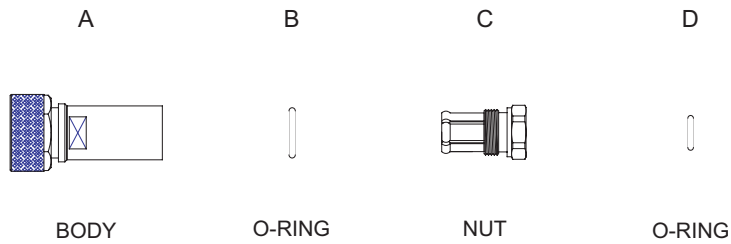
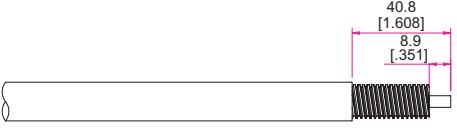
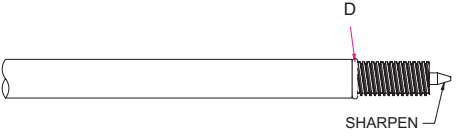
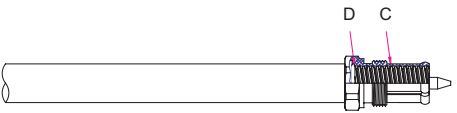
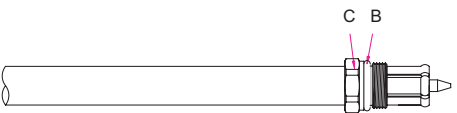
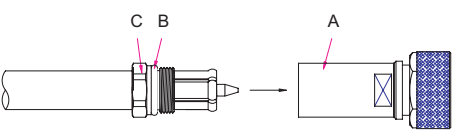

DIAGRAM	ASSEMBLY INSTRUCTION
	<p>Step 1: STRIP AS SHOWN .</p>
	<p>Step 2: PUT VASELINE ON " D " AND SLIDE O-RING " D " OVER CABLE .</p> <p>Step 3: SHARPEN CENTER CONDUCTOR TIP.</p>
	<p>Step 4: SLIDE NUT " C " OVER CABLE.</p>
	<p>Step 5: PUT VASELINE ON " B " AND SLIDE O-RING " B " OVER THE NUT " C " .</p>
	<p>Step 6: FINALLY SCREW " C " ON THE CONNECTOR BODY " A " .</p>

**This part number complies with RoHS.**

**Notice: JYEBAO reserves the right to make modifications deemed appropriate.**