

### Applications

- 3G / 4G Wireless Infrastructure
- CDMA, WCDMA, LTE, TD-LTE

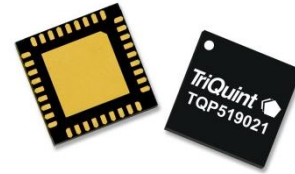

36-pin 6 x 6 mm Leadless Package

### Product Features

- High dynamic range
- Integrated LO/IF amplifiers and LO Switch
- Dual Channels for diversity
- RF Frequency Range : 680 – 920 MHz
- IF Frequency Range : 70 – 280 MHz
- 9 dB Conversion Gain
- +25.5 dBm Input IP3
- 10.8 dB Noise Figure
- +11.8 dBm Input P1dB
- Built-in high isolation LO Switch
- Power Shut-down Mode
- Optional Low Current Mode for IF amplifiers

### Functional Block Diagram

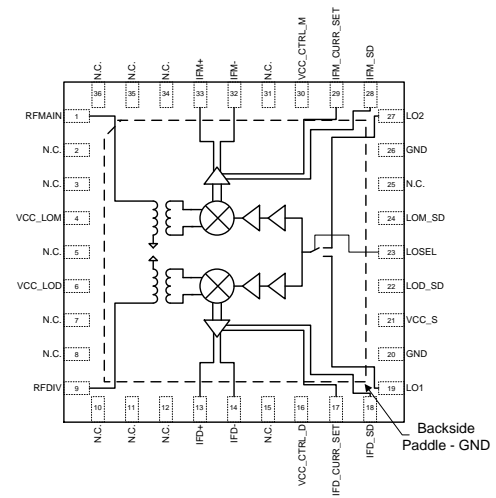

### General Description

The TQP519021 is a high-linearity dual-channel down-converter designed to meet the demanding performance, functionality, and cost goals of current and next generation mobile infrastructure base-stations. It provides high dynamic range performance in a low profile lead-free/RoHS-compliant surface-mount leadless package that measures 6x6 mm square.

The TQP519021 is a fully integrated diversity mixer that includes LO switch, two stage LO drivers, high-linearity mixers, RF balun and IF amplifiers. The IF amplifiers can be set to standard current or low current mode through logic input pins. The TQP519021 also integrates power down feature controlled by separate logic pin.

The TQP519021 is designed to provide 9 dB conversion gain, +25.5 dBm Input IP3, +11.8 dBm Input P1dB and a noise figure of 10.8 dB over the 680 – 920MHz frequency range for diversity receiver applications. TQP519021 is optimized for low side LO application but also works for High-side LO applications with slightly degraded linearity performance. The TQP519021 is footprint and pin compatible with TriQuint’s 1.7 – 2.2 GHz TQP569022 mixer for high band applications.

### Pin Configuration

Pin #	Symbol	Pin #	Symbol
1	RFMAIN	22	LOD_SD
4	VCC_LOM	23	LOSEL
6	VCC_LOD	24	LOM_SD
9	RFDIV	27	LO2
13, 14	IFD+, IFD-	28	IFM_SD
16	VCC_CTRL_D	29	IFM_CURR_SET
17	IFD_CURR_SET	30	VCC_CTRL_M
18	IFD_SD	32,33	IFM+, IFM-
19	LO1	20, 26	RF GND
21	VCC_S	All Others	NC or GND

### Ordering Information

Part No.	Description
TQP519021	Dual-channel Downconverter
TQP519021-PCB	Assembled Evaluation Board

Standard T/R size = 2500 pieces on a 13” reel.

## Absolute Maximum Ratings

Parameter	Rating
Storage Temperature	-55 to 150 °C
RF Input Power, CW, 50Ω, T=+25°C	+15 dBm
LO Input Power CW, 50Ω, T=+25°C	+5 dBm
V <sub>cc</sub> (pins 4, 6, 21) V <sub>ctrl</sub> (pins 16, 30)	+5.5 V

Operation of this device outside the parameter ranges given above may cause permanent damage.

## Recommended Operating Conditions

Parameter	Min	Typ	Max	Units
V <sub>cc</sub> (pins 4, 6, 21)	+3.3	+5	+5.25	V
T <sub>CASE</sub>	-40		+85	°C
T <sub>J</sub> (for >10 <sup>6</sup> hours MTTF)			190	°C
LO Power	-3	0	+3	dBm

Electrical specifications are measured at specified test conditions. Specifications are not guaranteed over all recommended operating conditions.

## Electrical Specifications

Test conditions unless otherwise noted: V<sub>cc</sub> = +5 V, Temp. = +25 °C, LSLO, Both Channels, LO power = 0 dBm  
RF = 820 MHz, LO = 680 MHz, IF = 140 MHz

Parameter	Conditions	Min	Typ	Max	Units
RF Frequency Range		680		920	MHz
LO Frequency Range		600		1100	MHz
IF Frequency Range		70	140	280	MHz
Conversion Gain	Standard Current Mode	7.5	9	11.5	dB
	Low Current Mode	6.5	8	10.5	dB
Gain Flatness			± 0.5		dB
Gain Variation over temp	-40 to +85 °C, referenced to +25 °C		±1.0		dB
Input IP3	Pin = -10 dBm/tone, Δf = 1 MHz	Standard Current Mode	+22.5	+25.5	dBm
		Low Current Mode	+16	+20	dBm
Input IP3 Variation Over Temp.	-40 to +85 °C, referenced to +25 °C		±1.0		dB
Input IP2	Pin = -10 dBm/tone	Standard Current Mode		+65	dBm
		Low Current Mode		+65	dBm
Input P1dB	Standard Current Mode		+11.8		dBm
	Low Current Mode		+7.3		dBm
SSB Noise Figure			10.8		dB
SSB Noise Figure Over Temp.	-40 to +85 °C, referenced to +25 °C		±1.3		dB
Noise Figure with Blocker	Pblocker = +8 dBm, RF = 860 MHz		18.6		dB
2LO – 2RF Spur Rejection	Pin = -10 dBm/tone		75		dBc
3LO – 3RF Spur Rejection	Pin = -10 dBm/tone	Standard Current Mode		90	dBc
		Low Current Mode		80	dBc
LO Leakage at RF port			-33		dBm
LO Leakage at IF port			-50		dBm
LO2 – LO1 Isolation		40	48		dB
Channel to Channel Isolation			53		dB
RF-IF Isolation			25		dB
RF Return Loss			12		dB
LO Return Loss			10		dB
IF Return Loss	With ext. IF balun TC4-1W-17LN+		15		dB

## Electrical Specifications (contd.)

Test conditions unless otherwise noted:  $V_{cc} = +5\text{ V}$ , Temp. =  $+25\text{ }^\circ\text{C}$ , LSLO, Both Channels, LO power = 0 dBm  
 $RF = 820\text{ MHz}$ ,  $LO = 680\text{ MHz}$ ,  $IF = 140\text{ MHz}$

Parameter	Conditions	Min	Typ	Max	Units
IF differential port impedance			200		Ohms
Total Supply Current	Standard Current Mode	240	295	350	mA
	Low Current Mode	150	195	250	mA
	Shut Down Mode		3.5		mA
Logic Low Voltage		0		+0.4	V
Logic High Voltage		+1.4		$V_{cc}$	V
LO Switching Time			100		ns
Logic Input Current	At 5V Logic High		50		$\mu\text{A}$
Thermal Resistance, $\theta_{jc}$	Junction to Case		23.4		$^\circ\text{C/W}$

## Application Circuit - TQP519021-PCB

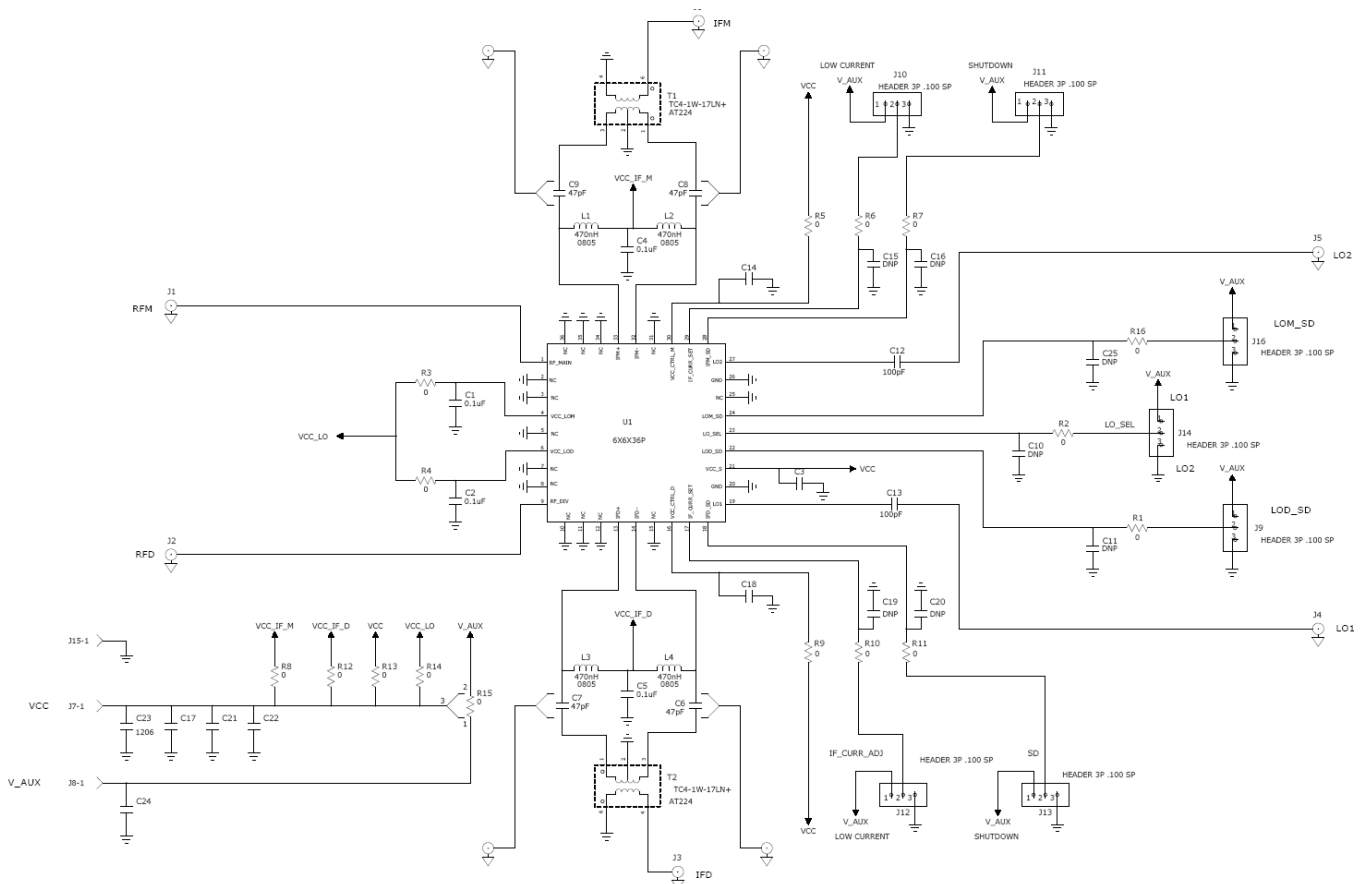

## TQP519021-PCB Evaluation Board

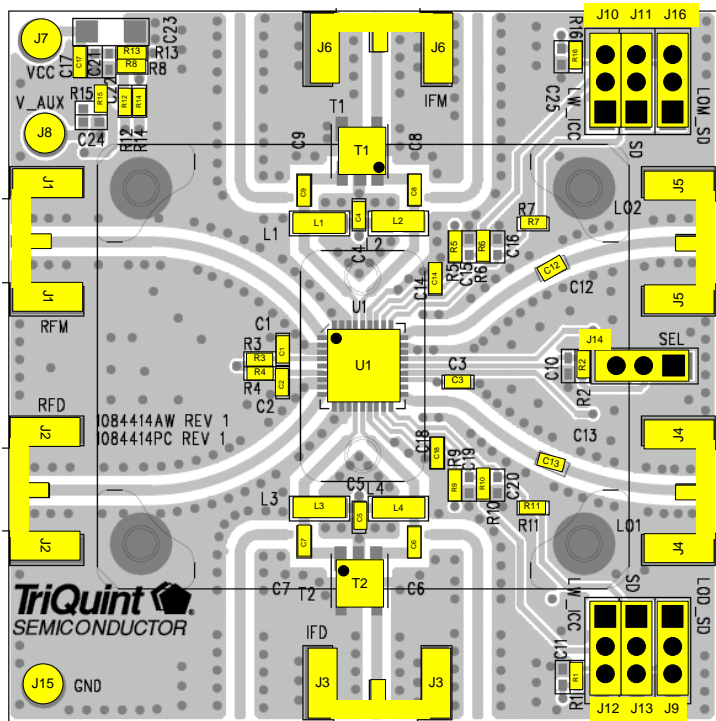

### PCB Material and Stack-up

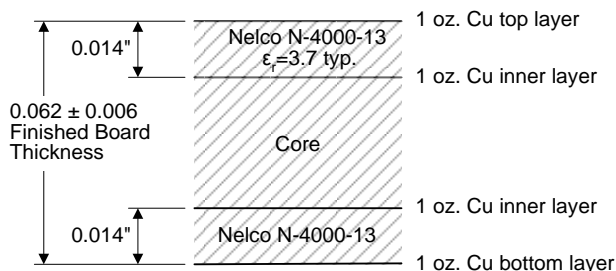

## Bill of Material - TQP519021-PCB

Reference Des.	Value	Description	Manuf.	Part Number
U1		Downconverter	TriQuint	TQP519021
R1 through R16	0 Ω	RES, 0402, 5%, 1/16W, Chip	Various	
C1–C5, C14, C17, C18	0.1 uF	CAP, 0402, 5%, 50V, NPO	Various	
C6, C7, C8, C9	47 pF	CAP, 0402, 5%, 50V, NPO	Various	
C12, C13	100 pF	CAP, 0402, 5%, 50V, NPO/COG	Various	
T1, T2		RF Transformer	Mini-Circuits	TC4-1W-17LN+
L1, L2, L3, L4	470 nH	IND, 0805, 5%, Ceramic Core	Coilcraft	0805CS-471XJL
C10, C11, C15, C16, C19–C25		Do Not Place		

## Jumper Settings - TQP519021-PCB

Jumper	Pin No.	Function	Low	High
J9	22	LOD_SD	Operation Mode	Shutdown Mode
J10	29	IFM_CURR_SET	Standard Current Mode	Low Current Mode
J11	28	IFM_SD	Operation Mode	Shutdown Mode
J12	17	IFD_CURR_SET	Standard Current Mode	Low Current Mode
J13	18	IFD_SD	Operation Mode	Shutdown Mode
J14	23	LOSEL	LO2	LO1
J16	24	LOM_SD	Operation Mode	Shutdown Mode

### Typical Performance Plots: Low-side LO with Standard Current Mode

Test conditions unless otherwise noted:  $V_{cc} = +5\text{ V}$ , Temp. =  $+25\text{ }^\circ\text{C}$ , Both Channels, LO power = 0 dBm  
 $R_F = 820\text{ MHz}$ , LO = 680 MHz, IF = 140 MHz

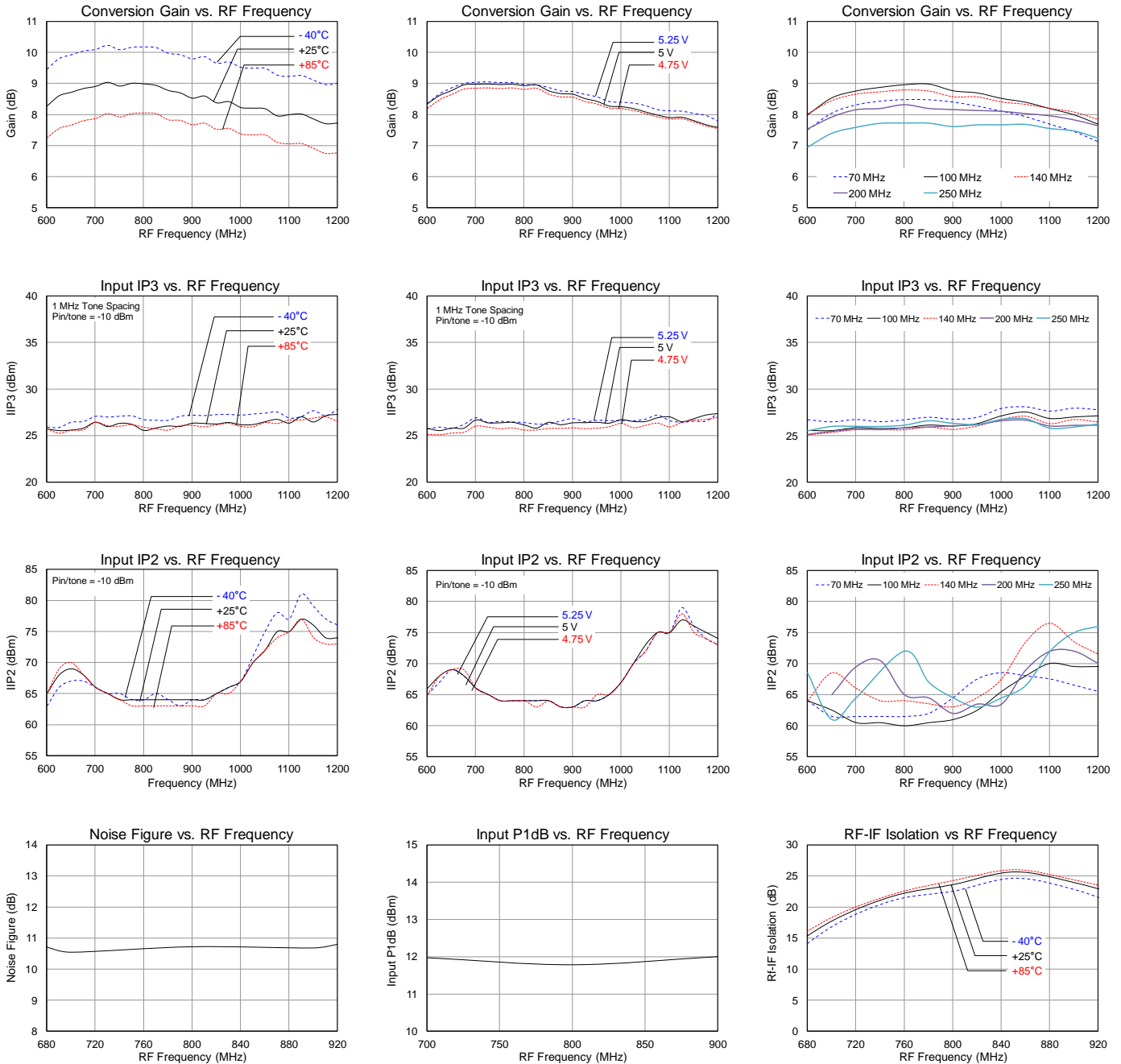

## Typical Performance Plots: Low-side LO with Standard Current Mode (cont.)

Test conditions unless otherwise noted:  $V_{cc} = +5\text{ V}$ , Temp. =  $+25\text{ }^\circ\text{C}$ , Both Channels, LO power = 0 dBm  
 $RF = 820\text{ MHz}$ ,  $LO = 680\text{ MHz}$ ,  $IF = 140\text{ MHz}$

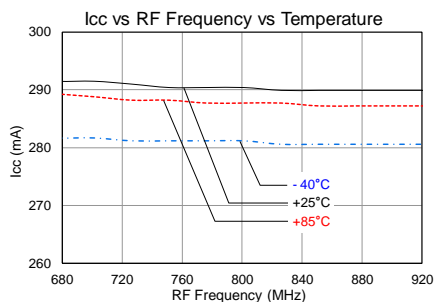
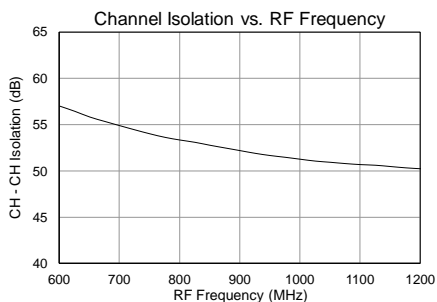
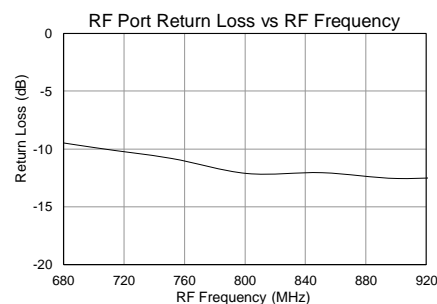
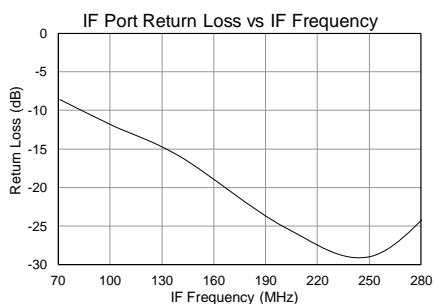
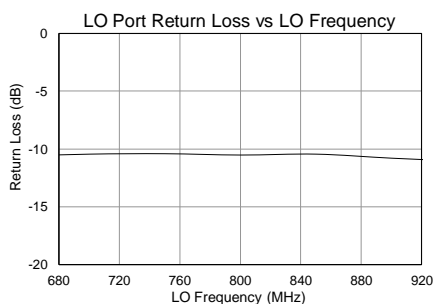
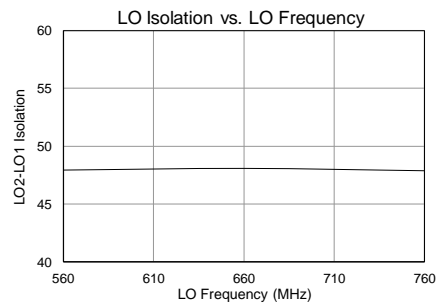
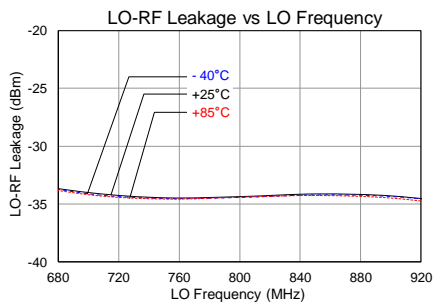
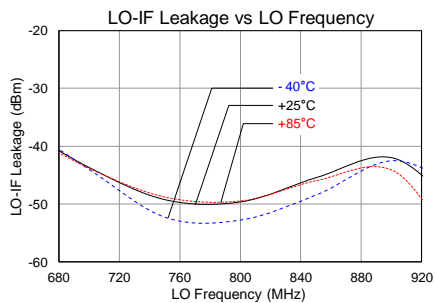

### Typical Performance Plots: Low-side LO with Low Current Mode

Test conditions unless otherwise noted:  $V_{cc} = +5\text{ V}$ , Temp. =  $+25\text{ }^\circ\text{C}$ , Both Channels, LO power = 0 dBm  
 $RF = 820\text{ MHz}$ , LO = 680 MHz, IF = 140 MHz

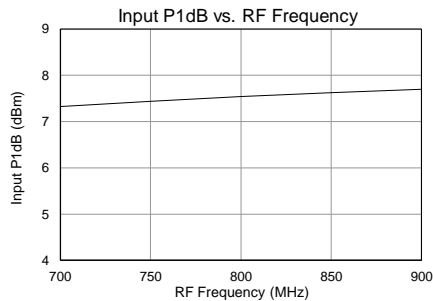
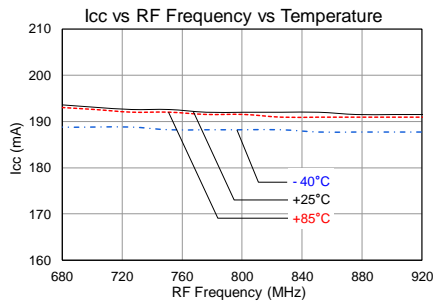
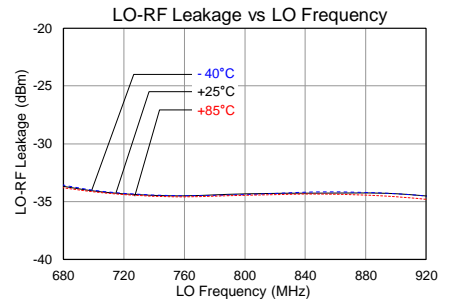
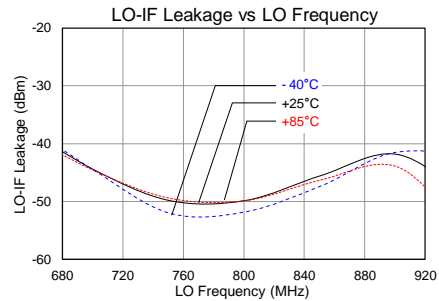
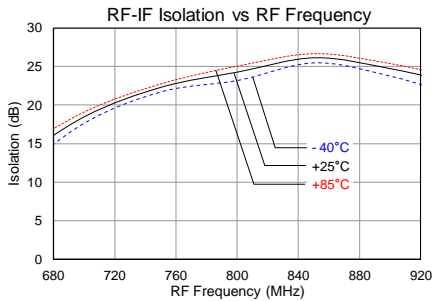
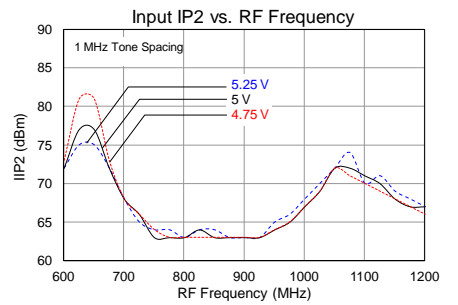
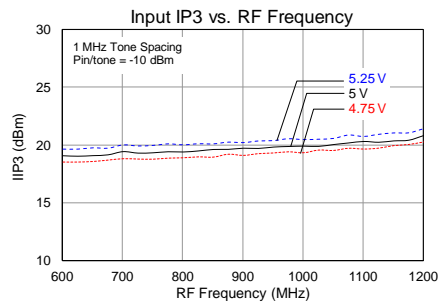
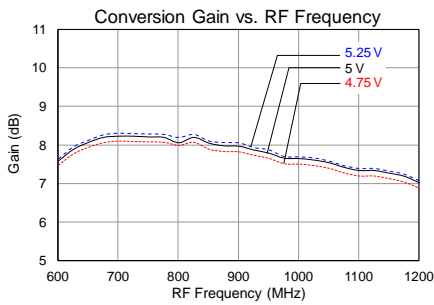
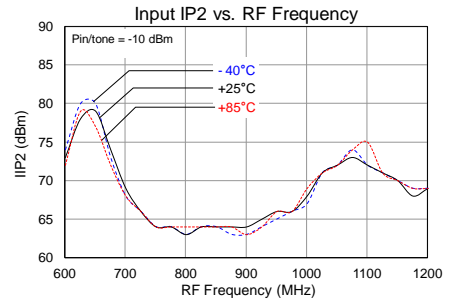
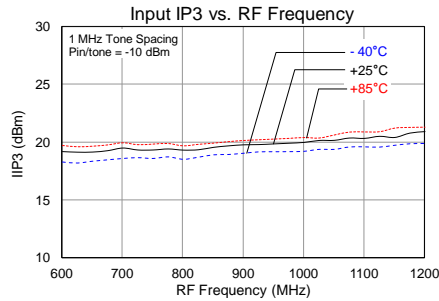
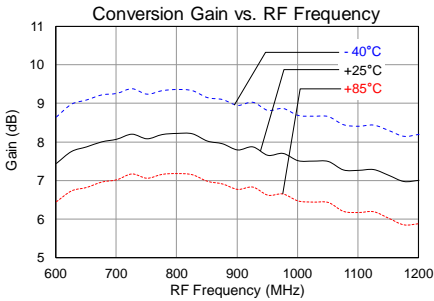

**Typical Performance Plots: High-side LO with Standard Current Mode**

Test conditions unless otherwise noted:  $V_{cc} = +5\text{ V}$ , Temp. =  $+25\text{ }^\circ\text{C}$ , Both Channels, LO power = 0 dBm  
RF = 820 MHz, LO = 960 MHz, IF = 140 MHz

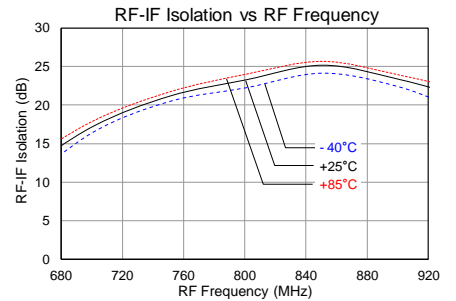
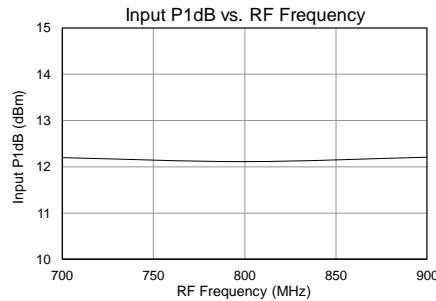
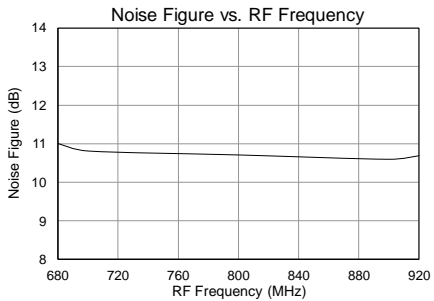
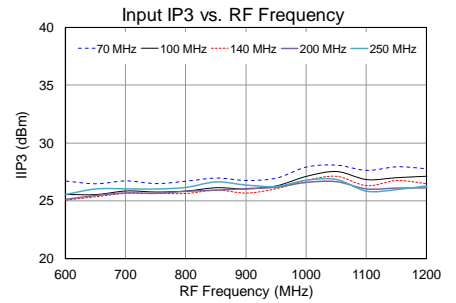
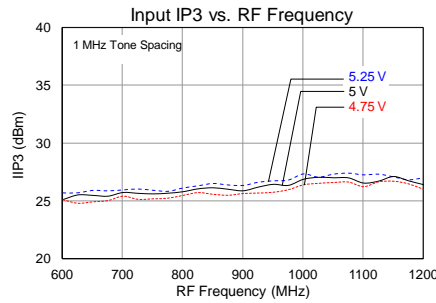
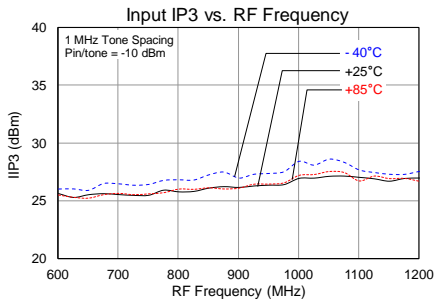
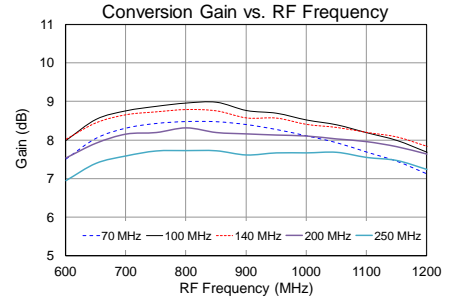
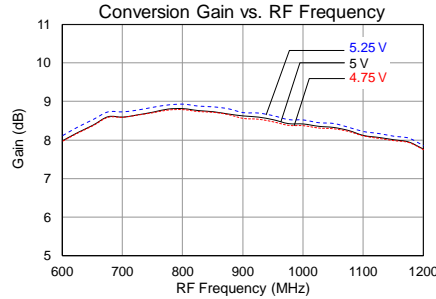
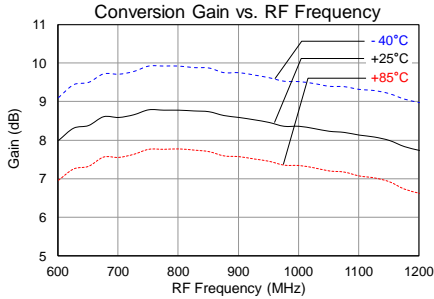

**Typical Performance Plots: High-side LO with Standard Current Mode**

Test conditions unless otherwise noted:  $V_{cc} = +5\text{ V}$ , Temp. =  $+25\text{ }^\circ\text{C}$ , Both Channels, LO power = 0 dBm  
 RF = 820 MHz, LO = 920 MHz, IF = 140 MHz

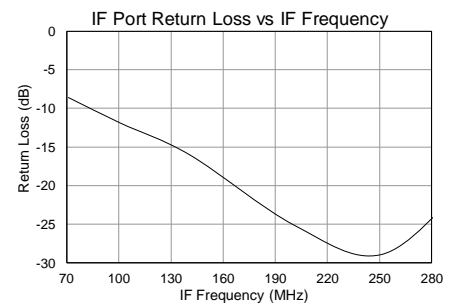
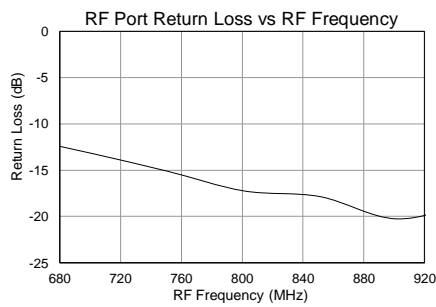
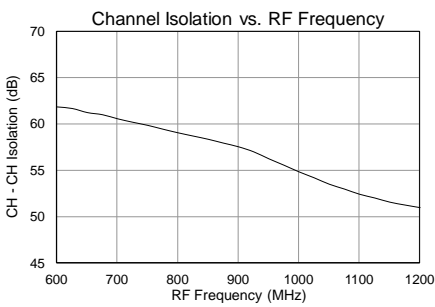
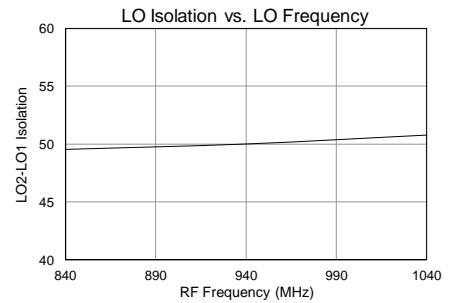
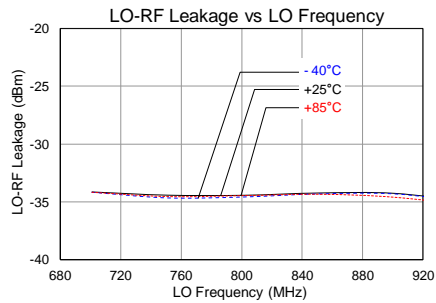
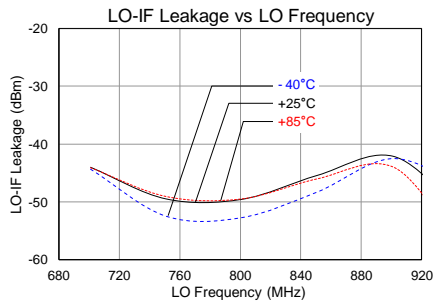

### Typical Performance Plots: High-side LO with Low Current Mode

Test conditions unless otherwise noted:  $V_{cc} = +5\text{ V}$ , Temp. =  $+25\text{ }^\circ\text{C}$ , HSLO, Both Channels, LO power = 0 dBm  
 RF = 820 MHz, LO = 920 MHz, IF = 140 MHz

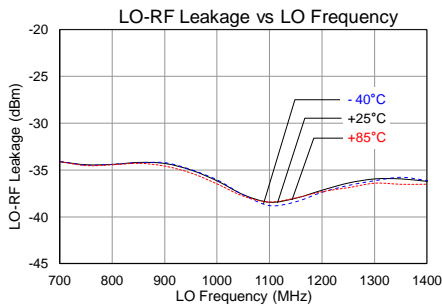
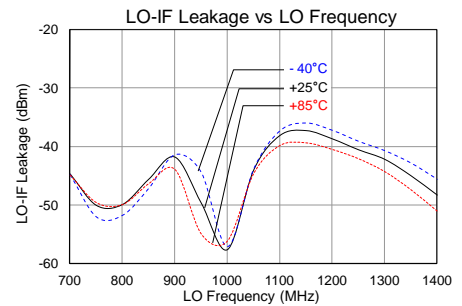
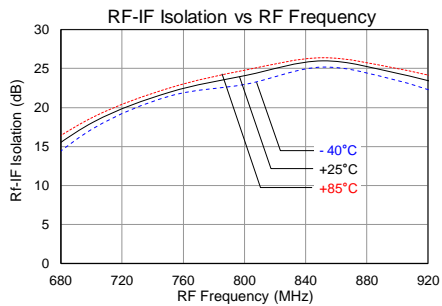
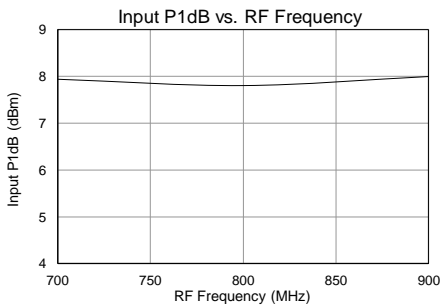
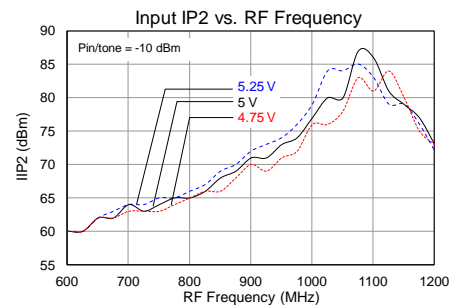
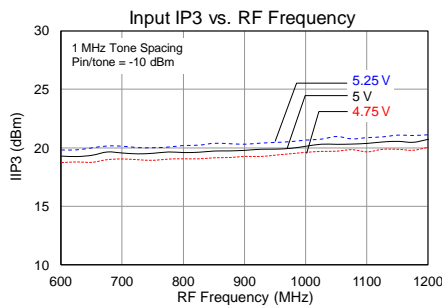
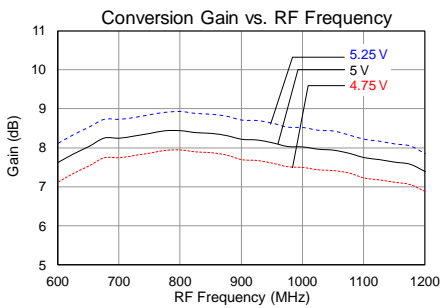
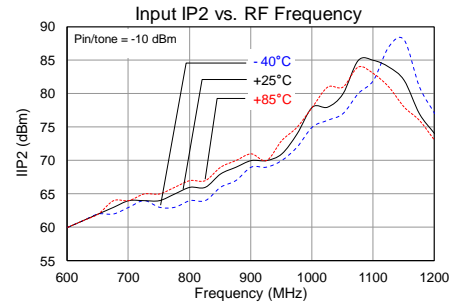
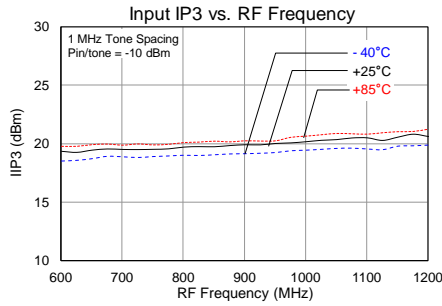
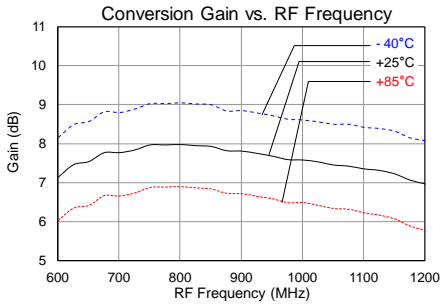

## Detailed Device Description

The TQP519021 is a high-linearity diversity dual-channel down-converter designed to meet the demanding performance, functionality, and cost goals of current and next generation mobile infrastructure base stations. This device is fully integrated diversity mixer that includes LO switch, two stage LO drivers, high-linearity mixers, RF balun and IF amplifiers. A single pole double throw (SPDT) high isolation switch has been included to select between two different LO inputs for frequency hopping applications. IF amplifiers can be set to standard current or low current mode through logic input pins. The TQP519021 also integrates power down feature controlled by separate logic pin.

### RF Port

The single-ended RF input ports of both the main and diversity channels are internally matched to 50 $\Omega$ , requiring no external matching components and DC-blocking capacitor. The RF input is internally transformed to a balanced signal using an internal, on-chip unbalanced-to-balanced (balun) transformer. The RF balun can support an RF input frequency range of 600-1200 MHz.

### LO Drivers and LO switch

The TQP519021 is optimized for a 600MHz to 1100MHz LO frequency range. The two stage LO drivers allow the LO input power to be in the range of  $\pm 3$  dBm. The LO section is optimized for low-side LO injection but also works for high-side LO applications with slightly degraded linearity performance.

As an added feature, a single pole double throw (SPDT) switch has been included to select between two different LO inputs for frequency hopping applications. The SPDT switch selects one of the two single-ended LO ports providing greater than 50 dB of LO1 to LO2 isolation. LO switching time is typically 100ns. The switch is controlled by a digital input (LOSEL), where logic-high selects LO1 and logic-low selects LO2. LO1 and LO2 inputs are internally matched to 50 $\Omega$ , requiring only 100pF DC-blocking capacitors.

### Passive Double-Balanced Mixer

The TQP519021 consists of a passive, double balanced, high-performance mixer that provides a very low conversion loss and high IIP3. Additionally, the balanced nature of the mixer provides for high channel to channel isolation.

### IF Amplifiers

The TQP519021 has an IF frequency range of 70 – 280 MHz, where the low-end frequency depends on the frequency response of the external IF components. The IF amplifiers follow the passive mixers in the signal path and can be operated outside of this range, but with a slight degradation in performance. The outputs require a supply voltage connection using inductive chokes. The differential output impedance of the IF amplifier is approximately 200  $\Omega$ . If operation in a 50  $\Omega$  system is desired, the output can be transformed to 50  $\Omega$  by using a 4:1 transformer. One can use a differential IF amplifier on the mixer IF ports, but a DC block is required on both IFD+/IFD- and IFM+/IFM- ports to keep external DC from entering the IF ports of the mixer. These differential ports are ideal for providing better IIP2 performance.

### Standard Current Mode and Low Current Mode

IF amplifiers can be set to standard current or low current mode through logic input pins. The IFD\_CURR\_SET and IFM\_CURR\_SET pins (17 and 29, respectively) are used to reduce the IF amplifier bias current. On the evaluation board, this is achieved by setting jumpers J10 and J12 as explained under Application Board section. The low current mode degrades IIP3 performance. The total current draw with low current mode is about 100mA lower than standard current mode. The IFD\_CURR\_SET and IFM\_CURR\_SET pins can be left either NC or GND for the applications not using low current mode.

### Shutdown Mode

The TQP519021 has additional integrated feature of power shut down for IF amplifiers and LO amplifier. The IFD\_SD and IFM\_SD pins (18 and 28, respectively) are used for IF amplifier shut down. The LOD\_SD and LOM\_SD pins (22 and 24, respectively) are used for LO amplifier shut down. On the evaluation board, this is achieved by setting jumpers J11, J13, J16 and J9 as explained under Application Board section. The total current draw during shut down mode is 3.5mA. The IFD\_SD and IFM\_SD pins can be left either NC or GND for the applications not using shutdown mode.

For any further technical questions, please email to [sjcappliations.engineering@tqs.com](mailto:sjcappliations.engineering@tqs.com).

## Pin Configuration and Description

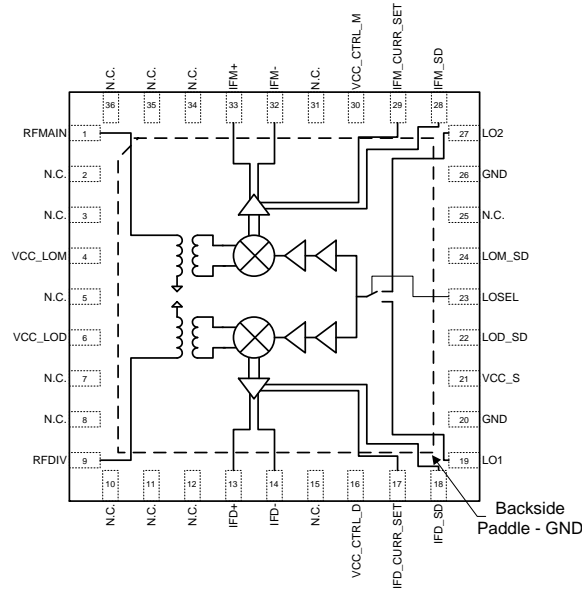

Pin No.	Symbol	Description
1	RFMAIN	Main Channel RF Input. Internally matched to 50Ω. No external DC block required.
4	VCC_LOM	DC Supply, +5V for LO amplifier. Bypass to GND with capacitor (0.1 uF) as close as possible to the pin.
6	VCC_LOD	
9	RFDIV	Diversity Channel RF Input. Internally matched to 50Ω. Internal DC block.
13	IFD+	Diversity mixer differential IF Output. Pull up inductors connected to Vcc from each pin.
14	IFD-	
16	VCC_CTRL_D	DC Supply, +5V for IF diversity amp. Bypass to GND with capacitor as close as possible to the pin.
17	IFD_CURR_SET	IF diversity amp bias control.
18	IFD_SD	IF diversity amp current shut down
19	LO1	Local oscillator input 1. Internally matched to 50Ω. External DC block required.
21	Vcc	DC Supply, +5V for LO Switch. Bypass to GND with capacitor as close as possible to the pin.
22	LOD_SD	LO diversity amp current shut down
23	LOSEL	Local oscillator select.
24	LOM_SD	LO main amp current shut down
27	LO2	Local oscillator input 2. Internally matched to 50Ω. External DC block required.
28	IFM_SD	IF main amp current shut down
29	IFM_CURR_SET	IF main amp bias control.
30	VCC_CTRL_M	DC Supply, +5V for IF main amp. Bypass to GND with capacitor as close as possible to the pin.
32	IFM+	Main mixer differential IF Output. Pull up inductors connected to Vcc from each pin.
33	IFM-	
2, 3, 5, 7, 8, 10, 11, 12, 15, 25, 31, 34, 35, 36	NC	No electrical connection. Provide land pads for PCB mounting integrity.
20, 26	GND	RF ground. These pins must be grounded to achieve the noted RF performance.

---

Backside Paddle	RF/DC GND	RF/DC Ground. Follow recommended via pattern and ensure good solder attach for best thermal and electrical performance.
-----------------	-----------	---

---

## Mechanical Information

### Package Marking and Dimensions

Marking: Part number – TQP519021  
 Year, week, country code - YYWW CCCC  
 Assembly code – AaXXXX

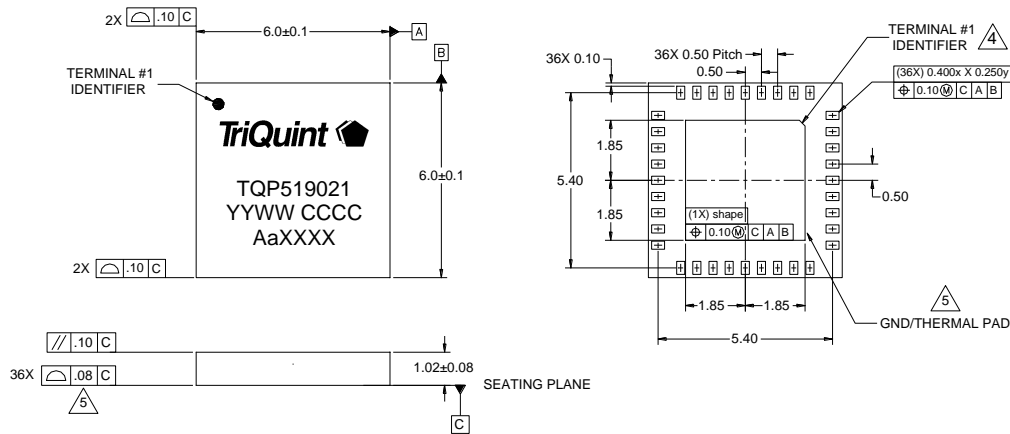

#### Notes:

1. All dimensions are in millimeters. Angles are in degrees.
2. Except where noted, this part outline conforms to JEDEC standard MO-270, Issue B (Variation DAE) for extra thin profile, fine pitch, internal stacking module (ISM).
3. Dimension and tolerance formats conform to ASME Y14.4M-1994.
4. The contact pin numbering convention and pin 1 identifier conform to JESD 95-1 SPP-012.
5. Co-planarity applies to the exposed ground/thermal pad as well as the contact pins.

## PCB Mounting Pattern

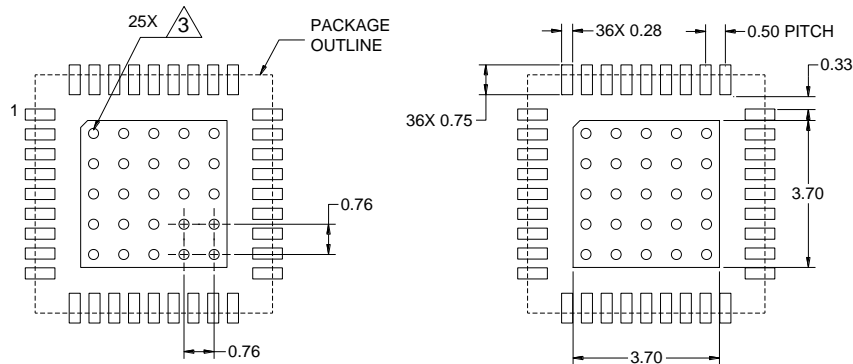

#### Notes:

1. All dimensions are in millimeters. Angles are in degrees.
2. Use 1 oz. copper minimum for top and bottom layer metal.
3. Vias are required under the backside paddle of this device for proper RF/DC grounding and thermal dissipation. We recommend a  $0.35$  mm ( $\#80/.0135$ " ) diameter bit for drilling via holes and a final plated thru diameter of  $0.25$  mm ( $0.10$ " ).
4. Ensure good package backside paddle solder attach for reliable operation and best electrical performance.

## Product Compliance Information

### ESD Sensitivity Ratings



Caution! ESD-Sensitive Device

ESD Rating: Class 1B  
Range:  $\geq 500$  V to  $< 1000$  V  
Test: Human Body Model (HBM)  
Standard: ESDA/JEDEC Standard JS-001-2012

ESD Rating: Class C3  
Range:  $\geq 1000$  V  
Test: Charged Device Model (CDM)  
Standard: JEDEC Standard JESD22-C101F

### MSL Rating

MSL Rating: Level 3  
Test: 260 °C convection reflow  
Standard: JEDEC Standard IPC/JEDEC J-STD-020

### Solderability

Compatible with both lead-free (260 °C max. reflow temperature) and tin/lead (245 °C max. reflow temperature) soldering processes.

Package contact plating: Electrolytic plated Au over Ni

### RoHs Compliance

This part is compliant with EU 2002/95/EC RoHS directive (Restrictions on the Use of Certain Hazardous Substances in Electrical and Electronic Equipment).

This product also has the following attributes:

- Lead Free
- Halogen Free (Chlorine, Bromine)
- Antimony Free
- TBBP-A (C<sub>15</sub>H<sub>12</sub>Br<sub>4</sub>O<sub>2</sub>) Free
- PFOS Free
- SVHC Free

## Contact Information

For the latest specifications, additional product information, worldwide sales and distribution locations, and information about TriQuint:

**Web:** [www.triquint.com](http://www.triquint.com)      **Tel:** +1.503.615.9000  
**Email:** [info-sales@triquint.com](mailto:info-sales@triquint.com)      **Fax:** +1.503.615.8902

For technical questions and application information:

**Email:** [sjcapplications.engineering@triquint.com](mailto:sjcapplications.engineering@triquint.com)

## Important Notice

The information contained herein is believed to be reliable. TriQuint makes no warranties regarding the information contained herein. TriQuint assumes no responsibility or liability whatsoever for any of the information contained herein. TriQuint assumes no responsibility or liability whatsoever for the use of the information contained herein. The information contained herein is provided "AS IS, WHERE IS" and with all faults, and the entire risk associated with such information is entirely with the user. All information contained herein is subject to change without notice. Customers should obtain and verify the latest relevant information before placing orders for TriQuint products. The information contained herein or any use of such information does not grant, explicitly or implicitly, to any party any patent rights, licenses, or any other intellectual property rights, whether with regard to such information itself or anything described by such information.

TriQuint products are not warranted or authorized for use as critical components in medical, life-saving, or life-sustaining applications, or other applications where a failure would reasonably be expected to cause severe personal injury or death.