

DESIGNED AND DIMENSIONED IN INCHES[MILLIMETERS]
ALL DIMENSIONS REFERENCE

DO NOT
SCALE FROM
THIS PRINT

PRFM0-J-C-HG-047A-SD

SERIES
-M0: SMPM

GENDER
-J: JACK

TYPE
-C: CABLE

FINISH
-HG: 30μ" HEAVY GOLD CENTER CONTACT,
10μ" GOLD OUTER CONTACT

TERMINATION
-D: DIRECT SOLDER

ORIENTATION
-S: STRAIGHT

CABLE CALLOUT
-047A: .047 STANDARD
CCA-047-PFA

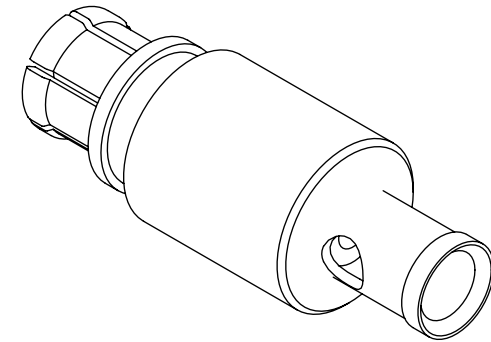
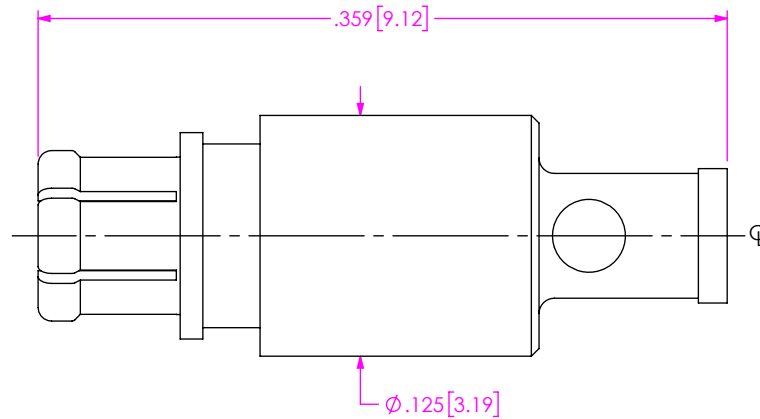

NOTES:
1. TRAYS TO BE STANDARD PACKAGING

<p>PROPRIETARY NOTE</p> <p>THIS DOCUMENT CONTAINS CONFIDENTIAL AND PROPRIETARY INFORMATION AND ALL DESIGN, MANUFACTURING, REPRODUCTION, USE, PATENT RIGHTS AND SALES RIGHTS ARE EXPRESSLY RESERVED BY SAMTEC, INC. THIS DOCUMENT SHALL NOT BE DISCLOSED, IN WHOLE OR PART, TO ANY UNAUTHORIZED PERSON OR ENTITY NOR REPRODUCED, TRANSFERRED OR INCORPORATED IN ANY OTHER PROJECT IN ANY MANNER WITHOUT THE EXPRESS WRITTEN CONSENT OF SAMTEC, INC.</p>		<p>samtec</p> <p>520 PARK EAST BLVD., NEW ALBANY, IN 47150 PHONE: 812-944-6733 FAX: 812-948-5047 e-Mail info@SAMTEC.com code 55322</p>	
<p>MATERIAL: DO NOT SCALE DRAWING SHEET SCALE: 10:1</p>		<p>DESCRIPTION: SMPM JACK ASSEMBLY</p>	
<p>SHELL, SOCKET, BUSHING & BACK BODY: BeCu BEAD: VICTREX® POLYMER</p>		<p>DWG. NO. PRFM0-J-C-HG-047A-SD</p>	
<p>F:\DWG\MISC\MKTG\PRFM0-J-C-HG-047A-SD-MKT.SLDDRW</p>		<p>BY: SHERRY W 2/5/2018 SHEET 1 OF 2</p>	

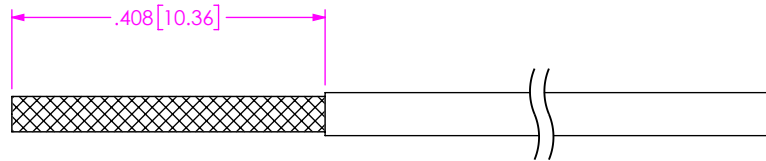

IN PROCESS 1
STRIP CONDUCTOR

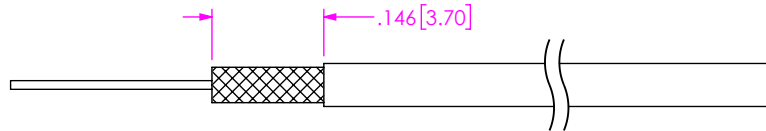

IN PROCESS 2
TRIM BRAID AND DIELECTRIC

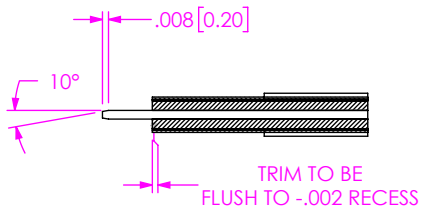

SECTION "A"-"A"

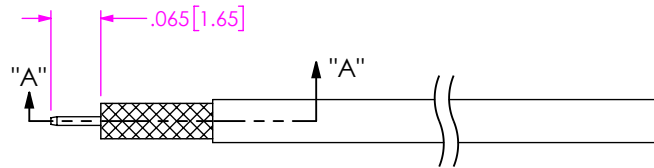

IN PROCESS 3
TRIM CENTER CONDUCTOR

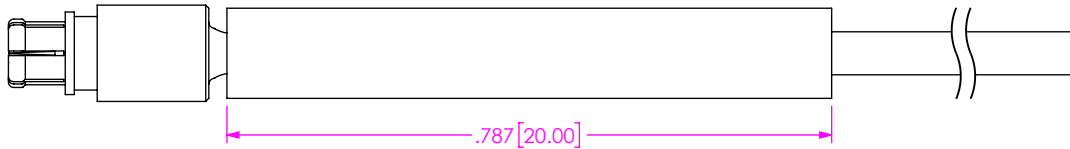

IN PROCESS 4
ADD HEAT SHRINK & SUB ASSEMBLY
SOLDER CABLE TO BACK BODY

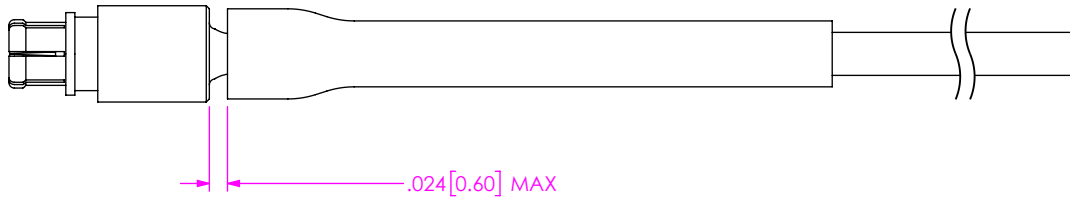

IN PROCESS 5
APPLY HEAT TO SHRINK TUBING

PROPRIETARY NOTE
THIS DOCUMENT CONTAINS CONFIDENTIAL AND PROPRIETARY INFORMATION AND ALL DESIGN, MANUFACTURING, REPRODUCTION, USE, PATENT RIGHTS AND SALES RIGHTS ARE EXPRESSLY RESERVED BY SAMTEC, INC. THIS DOCUMENT SHALL NOT BE DISCLOSED, IN WHOLE OR PART, TO ANY UNAUTHORIZED PERSON OR ENTITY NOR REPRODUCED, TRANSFERRED OR INCORPORATED IN ANY OTHER PROJECT IN ANY MANNER WITHOUT THE EXPRESS WRITTEN CONSENT OF SAMTEC, INC.



520 PARK EAST BLVD, NEW ALBANY, IN 47150
PHONE: 812-944-6733 FAX: 812-948-5047
e-Mail info@SAMTEC.com code 55322

DO NOT SCALE DRAWING
SHEET SCALE: 4:1

DESCRIPTION: SMPM JACK ASSEMBLY

DWG. NO. PRFM0-J-C-HG-047A-SD

BY: SHERRY W 2/5/2018 SHEET 2 OF 2