

# PNZ108CL (PN108CL)

## Silicon planar type

For optical control systems

### ■ Features

- High sensitivity:  $I_L = 3.5 \text{ mA (min.)}$
- Narrow directivity characteristics for effective use of light input
- Fast response:  $t_r = 5 \text{ } \mu\text{s (typ.)}$
- Signal mixing capability using base pin
- Small size (low in height) package

### ■ Absolute Maximum Ratings $T_a = 25^\circ\text{C}$

Parameter	Symbol	Rating	Unit
Collector-emitter voltage (Base open)	$V_{CEO}$	20	V
Collector-base voltage (Emitter open)	$V_{CBO}$	30	V
Emitter-collector voltage (Base open)	$V_{ECO}$	3	V
Emitter-base voltage (Collector open)	$V_{EBO}$	5	V
Collector current	$I_C$	20	mA
Collector power dissipation	$P_C$	100	mW
Operating ambient temperature	$T_{opr}$	-25 to +85	$^\circ\text{C}$
Storage temperature	$T_{stg}$	-30 to +100	$^\circ\text{C}$

### ■ Electrical-Optical Characteristics $T_a = 25^\circ\text{C} \pm 3^\circ\text{C}$

Parameter	Symbol	Conditions	Min	Typ	Max	Unit
Photocurrent *1	$I_L$	$V_{CE} = 10 \text{ V}, L = 500 \text{ lx}$	3.5			mA
Collector-emitter cutoff current (Base open)	$I_{CEO}$	$V_{CE} = 10 \text{ V}$		0.05	2.0	$\mu\text{A}$
Collector-emitter saturation voltage *1	$V_{CE(sat)}$	$I_L = 1 \text{ mA}, L = 1000 \text{ lx}$		0.3	0.6	V
Peak sensitivity wavelength	$\lambda_{PD}$	$V_{CE} = 10 \text{ V}$		900		nm
Half-power angle	$\theta$	The angle when the photocurrent is halved		80		$^\circ$
Rise time *2	$t_r$	$V_{CC} = 10 \text{ V}, I_L = 5 \text{ mA}, R_L = 100 \text{ } \Omega$		5		$\mu\text{s}$
Fall time *2	$t_f$			6		$\mu\text{s}$

Note) 1. Measuring methods are based on JAPANESE INDUSTRIAL STANDARD JIS C 7030 measuring methods for transistors.

2. Spectral sensitivity characteristics: Sensitivity for wave length over 400 nm maximum sensitivity ratio is 100%.
3. This device is designed by disregarding radiation.
4. \*1:Source: Tungsten lamp (color temperature 2 856K)

\*2: Switching time measurement circuit

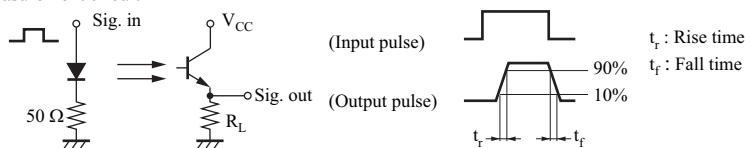

Note) The part number in the parenthesis shows conventional part number.

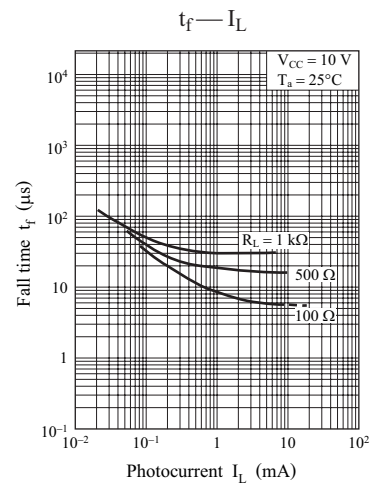
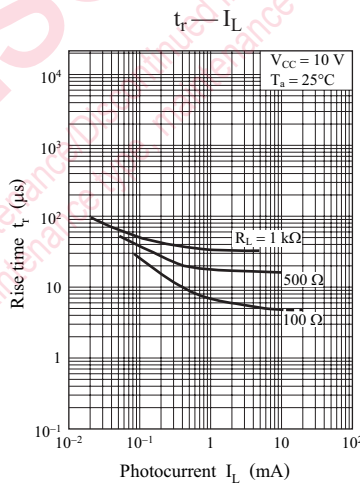
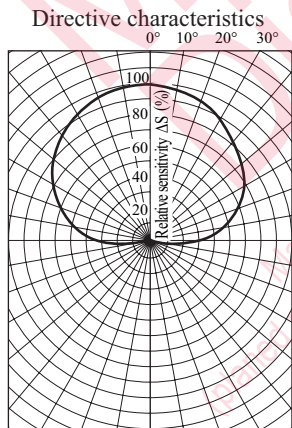
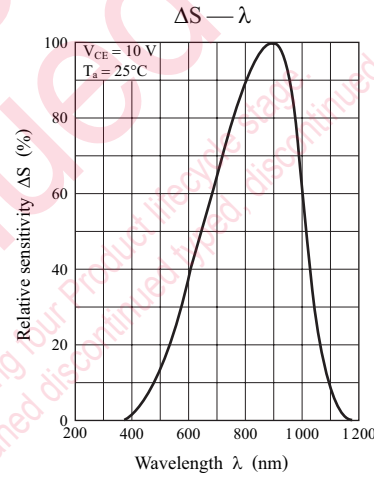
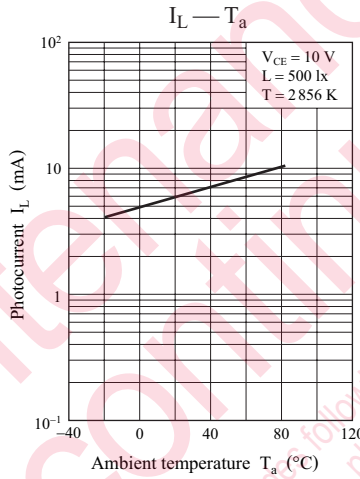
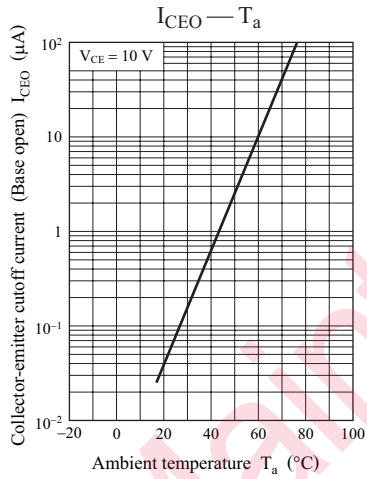
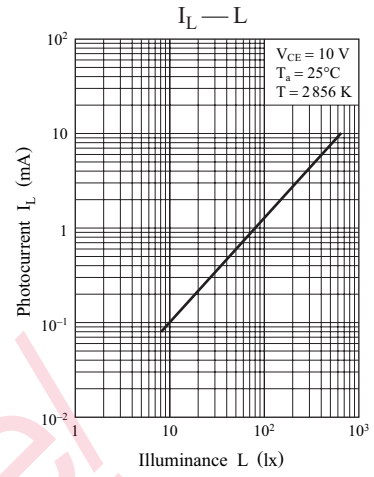
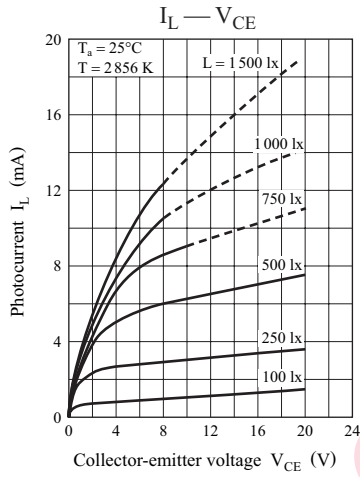
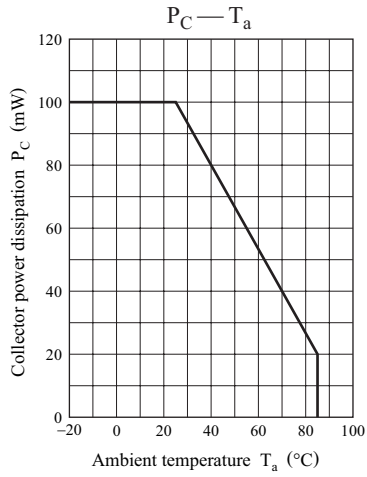

■ Package (Unit: mm)

MPDLTN3S0001

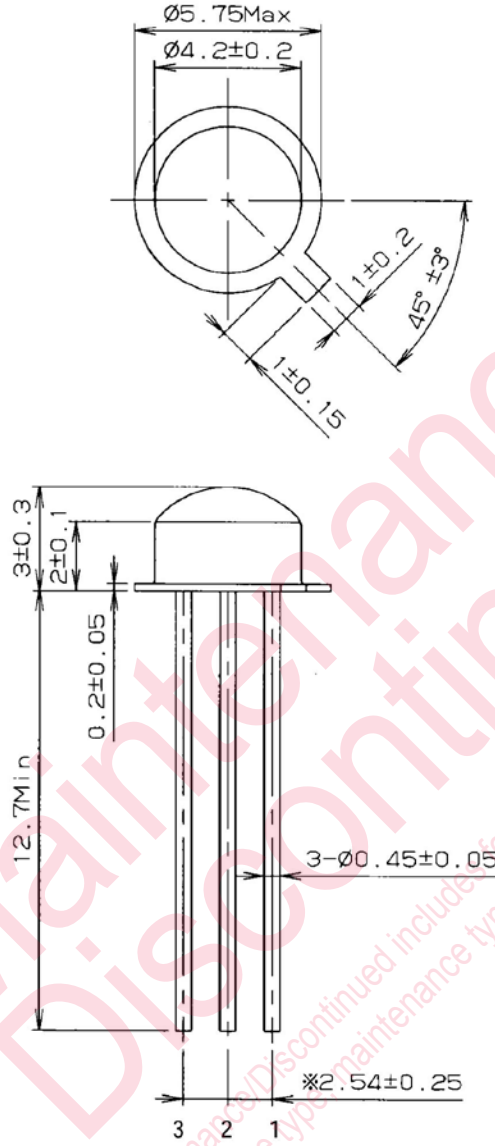

- Pin name
- 1: Emitter
- 2: Base
- 3: Collector

## Request for your special attention and precautions in using the technical information and semiconductors described in this book

- (1) If any of the products or technical information described in this book is to be exported or provided to non-residents, the laws and regulations of the exporting country, especially, those with regard to security export control, must be observed.
- (2) The technical information described in this book is intended only to show the main characteristics and application circuit examples of the products. No license is granted in and to any intellectual property right or other right owned by Panasonic Corporation or any other company. Therefore, no responsibility is assumed by our company as to the infringement upon any such right owned by any other company which may arise as a result of the use of technical information described in this book.
- (3) The products described in this book are intended to be used for standard applications or general electronic equipment (such as office equipment, communications equipment, measuring instruments and household appliances).  
Consult our sales staff in advance for information on the following applications:
  - Special applications (such as for airplanes, aerospace, automobiles, traffic control equipment, combustion equipment, life support systems and safety devices) in which exceptional quality and reliability are required, or if the failure or malfunction of the products may directly jeopardize life or harm the human body.
  - Any applications other than the standard applications intended.
- (4) The products and product specifications described in this book are subject to change without notice for modification and/or improvement. At the final stage of your design, purchasing, or use of the products, therefore, ask for the most up-to-date Product Standards in advance to make sure that the latest specifications satisfy your requirements.
- (5) When designing your equipment, comply with the range of absolute maximum rating and the guaranteed operating conditions (operating power supply voltage and operating environment etc.). Especially, please be careful not to exceed the range of absolute maximum rating on the transient state, such as power-on, power-off and mode-switching. Otherwise, we will not be liable for any defect which may arise later in your equipment.
  - Even when the products are used within the guaranteed values, take into the consideration of incidence of break down and failure mode, possible to occur to semiconductor products. Measures on the systems such as redundant design, arresting the spread of fire or preventing glitch are recommended in order to prevent physical injury, fire, social damages, for example, by using the products.
- (6) Comply with the instructions for use in order to prevent breakdown and characteristics change due to external factors (ESD, EOS, thermal stress and mechanical stress) at the time of handling, mounting or at customer's process. When using products for which damp-proof packing is required, satisfy the conditions, such as shelf life and the elapsed time since first opening the packages.
- (7) This book may be not reprinted or reproduced whether wholly or partially, without the prior written permission of our company.