



## DRH SERIES

DIN RAIL MOUNT SOLID STATE CONTACTORS



### Features

- Ratings up to 18 & 20 Amps at 600 VAC
- Fits standard 35 mm DIN Rail
- Integrated over-temperature protection
- Alarm output in case of over-temperature
- Multicolor LED with input status and alarm indicator
- AC or DC control
- Zero Voltage (resistive loads) or instantaneous (inductive loads) turn-on output
- C-UL-US Listed, IEC Rated, CE & RoHS Compliant, Horsepower Rated
- Built-in Overvoltage Protection
- Fan controlled through thermistor and microprocessor to optimize fan operation



### PRODUCT SELECTION

Control Voltage	18 A	20 A
90-280 VAC/VDC	DRH3P60A18	DRH3P60A20
4-32 VDC	DRH3P60D18	DRH3P60D20

Output <sup>(1)</sup>

Description	18 A	20 A
Operating Voltage (47-63Hz) [Vrms]	48-600	48-600
Transient Overvoltage [Vpk] <sup>(2)</sup>	1200	1200
Maximum Off-State Leakage Current @ Rated Voltage [mArms]	3	3
Minimum Off-State dV/dt @ Maximum Rated Voltage [V/μsec]	500	500
Load Current, General Use UL508/IEC62314 @ 40°C [Arms] <sup>(3)</sup>	18	20
Load Current, Motor Starting UL508 FLA/IEC62314 @ 40°C [Arms] <sup>(3)</sup>	7.6	7.6
Minimum Load Current [Arms]	0.15	0.15
Maximum Surge Current [Apk] 1Cycle 60Hz	750	750
Maximum Surge Current [Apk] 1Cycle 50Hz	716	716
Maximum I <sup>2</sup> t for Fusing (8.33 msec) [A <sup>2</sup> sec]	2330	2330
Maximum I <sup>2</sup> t for Fusing (10 msec) [A <sup>2</sup> sec]	2560	2560
Maximum On-State Voltage Drop @ Rated Current [Vpk]	1.35 per channel	1.35 per channel
Minimum Power Factor (with Maximum Load)	0.5	0.5
Motor Rating UL 508/ IEC60947-4-2 [HP/kW] :240 VAC	2/1.5	2/1.5
Motor Rating UL 508/ IEC60947-4-2 [HP/kW] :380 VAC	3/2.2	3/2.2
Motor Rating UL 508/ IEC60947-4-2 [HP/kW] :480 VAC	5/3.7	5/3.7

Input <sup>(1)</sup>

Description	DRH3P60Dx	DRH3P60Ax
Control Voltage Range	4-32 VDC	90-280 VAC/VDC
Minimum Turn-On Voltage	4 VDC	90 VAC/VDC
Must Turn-Off Voltage	1 VDC	10 VAC
Minimum Input Current (for on-state)	2 mA	1 mA
Maximum Input Current	17 mA	3 mA
Nominal Input Resistance [Ohms]	2k	100k
Maximum Turn-On Time [msec]	1 Cycle <sup>(4)</sup>	30
Maximum Turn-Off Time [msec]	1 Cycle	40

Power Supply <sup>(1)</sup>

Description	DRH3P60Dx	DRH3P60Ax
Voltage Range	8-32 VDC	90-265 VAC/VDC
Minimum Turn-On Voltage	8 VDC	90 VAC/VDC
Must Turn-Off Voltage	3 VDC	5 VAC/VDC
Maximum Source Current [mA]	125	40
Maximum Start Up Time [msec]	20	50
Maximum Shut Off Time [msec]	40	500

## Alarm Output <sup>(1)</sup>

Description	DRH3P60xxx
Maximum Contact Switching Voltage [Volts]	200 VDC, 120 VAC
Rated Current Resistive [A] <sup>(5)</sup>	0.5
Minimum Recommended Contact Load [mA]	10
Static Contact Resistance (max. init.) [Ohms]	0.2
Turn-On / Off Condition	See Status Chart

## General <sup>(1)</sup>

Description	Parameters
Dielectric Strength, Input/Output/Base (50/60Hz) <sup>(6)</sup>	3750 Vrms
Minimum Insulation Resistance (@ 500 VDC)	10 <sup>9</sup> Ohm
Maximum Capacitance, Input/Output	20 pF
Ambient Operating Temperature Range <sup>(7)</sup>	-10 to 70 °C
Ambient Storage Temperature Range	-40 to 70 °C
Weight (typical)	2 Controlled Legs (7.4 oz [210 g]) / 3 Controlled Legs (8.5 oz [242 g])
Housing Material	UL94 V-0
Housing Color	Black and Light Gray
LED Status Indicator (color)	See Status Chart
Short Circuit Current Rating <sup>(8)</sup>	100kA
Pollution Degree	2
Protection Degree <sup>(9)</sup>	IP20
Humidity	85% non-condensing
Control and Auxiliary Contact Terminal Screw Torque Range (lb-in/Nm)	12 / 1.36
Load Terminal Screw Torque Range (lb-in/Nm)	15 / 1.7
Input Terminal Wire Capacity	18-12 AWG (IEC 1-4 mm2) (stranded /solid)
Output Terminal Wire Capacity	18-10 AWG (IEC 1-6 mm2) (stranded /solid)



## MECHANICAL SPECIFICATIONS

Tolerance:  $\pm 0.02$  in / 0.5 mm

All dimensions are in: inches [millimeters]

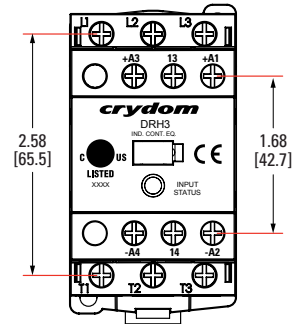
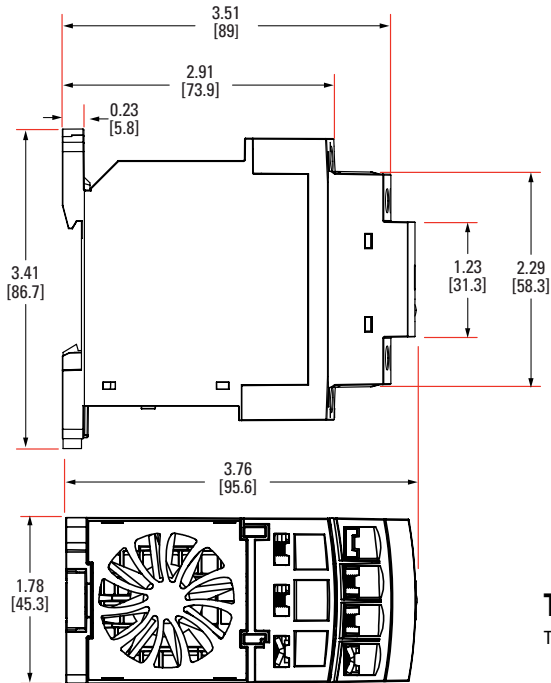

### TERMINAL SCREW TYPE

Top/Bottom view (Fig. 1)

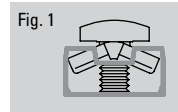

## THERMAL DERATE INFORMATION

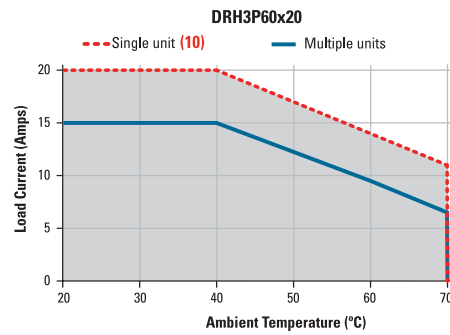
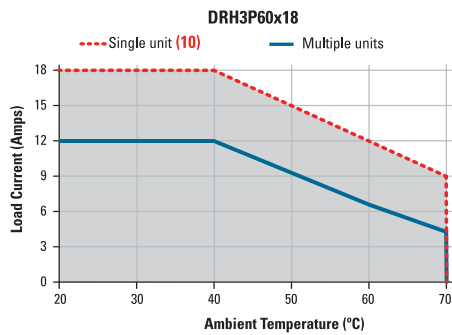



# WIRING AND BLOCK DIAGRAM

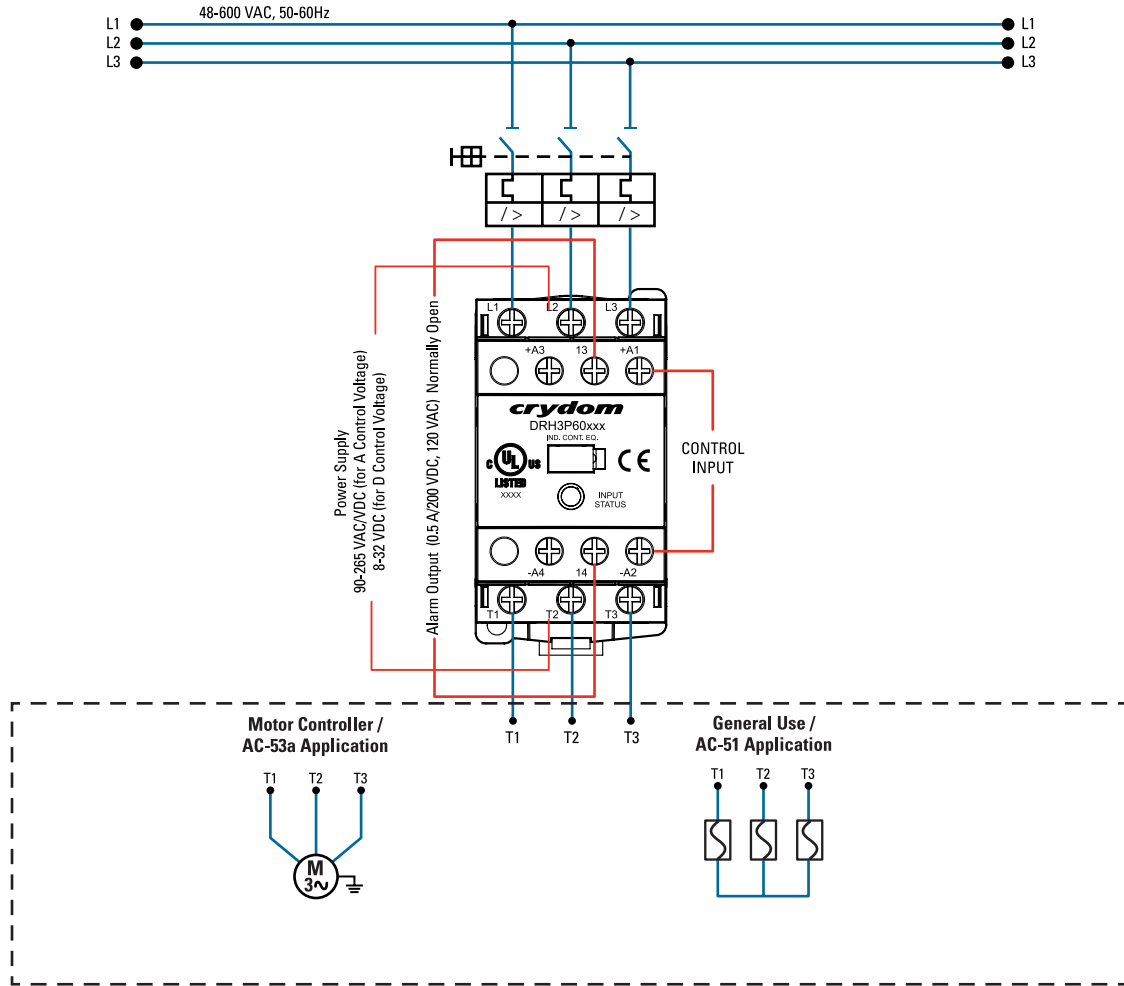

**DRHP60x18**  
(3 controlled legs model)  
Main Circuit

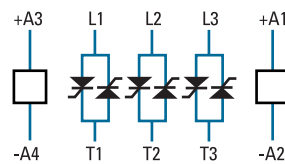

**Alarm Output**  
(DRHP60x18 & DRHP60x20)



**DRHP60x20**  
(2 controlled legs model)  
Main Circuit

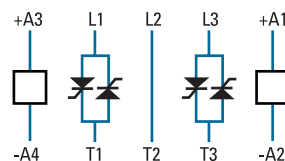



# SHORT CIRCUIT AND OVERLOAD PROTECTION FOR ALL DEVICES

**IEC standard 60947-4-1** make a distinction between two different types of protection, (called “coordination”), which are designated types “1” and “2”. Any short-circuit that occurs is cleared safely by either type of coordination. The only difference between the 2 categories concerns the extent of the SSR damage caused by the short-circuit.

**Type “1”** coordination requires that in the event of a short-circuit, the Solid State Contactor does not endanger personnel or installations, but permanent damage to the SSC is permissible. In this case the SSC may need to be replaced. For this type of co-ordination, the use of fusing or circuit breakers adequate to protect the system and wiring from short circuits, (but not specifically considering SSC protection), can be used.

**Type “2”** coordination requires that under a short-circuit condition, the circuit is interrupted, the SSC does not endanger persons or installations, and in addition the SSR will be able to operate after the fault condition is repaired.

## Type of coordination 1

For resistive loads:

Protection by Thermal Magnetic Circuit Breaker or by Fuse (11)			
Nominal Current	Class gG fuses (example from Littelfuse)	Solid State Contactor 2 controlled legs	Solid State Contactor 3 controlled legs
0.15-20 A	CY14X51G25	DRH3P60x20	DRH3P60x18 (up to 18A)

For motor loads:

Protection by Thermal Magnetic Circuit Breaker or by Fuse (11)				
Nominal Motor Current	Thermal Magnetic Circuit Breaker (Schneider Electric)	Class gG fuses (example from Littelfuse)	Solid State Contactor 2 controlled legs	Solid State Contactor 3 controlled legs
0.40-0.63 A	GV2ME04 / GV2P04	CY14X51G16	DRH3P60x20	DRH3P60x18
0.63-1 A	GV2ME05 / GV2P05	CY14X51G16	DRH3P60x20	DRH3P60x18
1-1.6 A	GV2ME06 / GV2P06	CY14X51G25	DRH3P60x20	DRH3P60x18
1.6-2.5 A	GV2ME07 / GV2P07	CY14X51G25	DRH3P60x20	DRH3P60x18
2.5-4 A	GV2ME08 / GV2P08	CY14X51G25	DRH3P60x20	DRH3P60x18
4-6.3 A	GV2ME10 / GV2P10	CY14X51G40	DRH3P60x20	DRH3P60x18
6.3-10 A	GV2ME14 / GV2P14	CY14X51G40	DRH3P60x20 (up to 7.6A)	DRH3P60x18 (up to 7.6A)

## Type of coordination 2

For resistive loads:

Protection by Fuse (11)					
Nominal Current	Semiconductor fuses with less than 2330 A <sup>2</sup> s			Solid State Contactor 2 controlled legs	Solid State Contactor 3 controlled legs
	Littelfuse	SIBA1 (Cylindric)	Ferraz (Cylindric)		
0.15-20 A	LA50QS35-4	50 058 06.32	Z093908	DRH3P60x20	DRH3P60x18 (up to 18A)

For motor loads:

Protection by Fuse (11)					
Nominal Motor Current	Semiconductor fuses with less than 2330 A <sup>2</sup> s			Solid State Contactor 2 controlled legs	Solid State Contactor 3 controlled legs
	Littelfuse	SIBA1 (Cylindric)	Ferraz (Cylindric)		
0.15-7.6 A	LA50QS40-4	50 058 06.40	A093909	DRH3P60x20	DRH3P60x18



# STATUS CHART

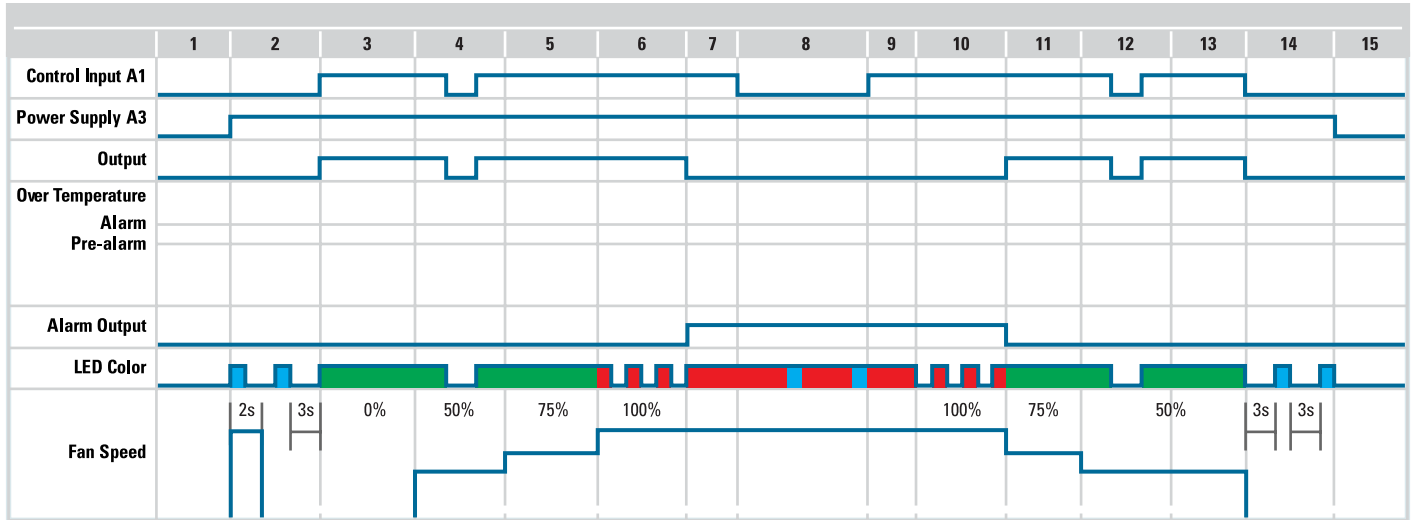

Step	Description
1, 15	Initial Condition
2, 14	Stand by condition. LED is blinking Blue. Fan is activated at full speed for 2 seconds after power is applied to A3
3	A1 is On, Output is activated, temperature rises. LED is Green
4, 12	Fan is activated at 50% speed. If A1 is disabled, LED changes to blinking Blue
5, 11	Fan is at 75% speed
6, 10	LED changes to blinking Red, fan is at full speed
7	Output is Off, Alarm Output is On, LED changes to solid Red
8	If A1 is disabled while alarm output is active, LED alternates between Blue and Red
9	LED is solid Red, temperature starts to fall
13	Fan is activated at 50% speed, temperature is steady

### LED Color

■ Blue    
 ■ Green    
 ■ Red



# ORDERING OPTIONS

Example : DRH3P60A18R

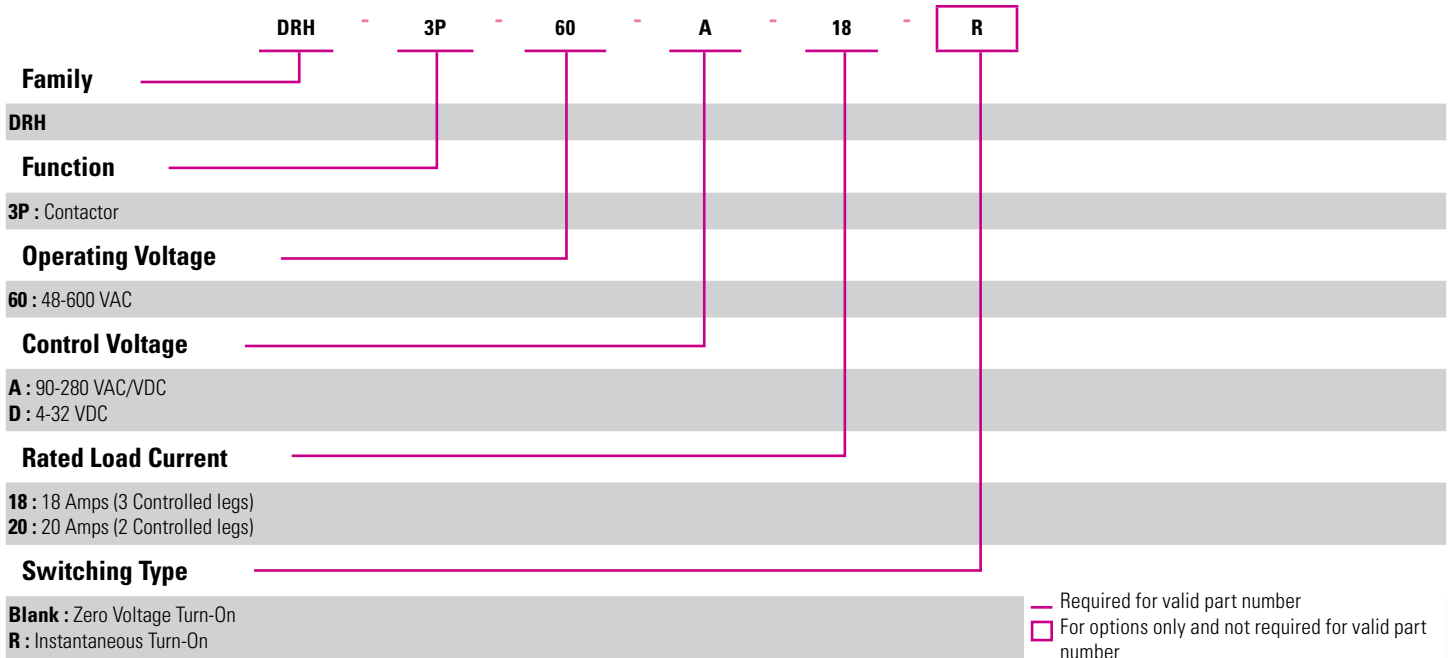

# GENERAL NOTES

- (1) All parameters at 25°C unless otherwise specified.
- (2) Relay will self trigger between 950-1200V, Not suitable for capacitive loads.
- (3) Mounted in the Vertical position.
- (4) Turn-on time for Instantaneous turn-on version is 4 msec.
- (5) Decrease Maximum Current 15mA/°C above 40°C ambient temperature.
- (6) For input to alarm output the dielectric strength is 1.5kV.
- (7) UL approval up to 40°C surrounding temperature.
- (8) 100kA, 480 VAC, when protected with CC class fuses rated 600VAC, 20 A or equivalent.
- (9) IP20 rating is not associated with the UL approval.
- (10) Minimum spacing to obtain max. current is 22mm between adjacent units.
- (11) Combination of these Protective Devices and Solid State Contactor have not been evaluated by UL.

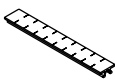

# ACCESSORIES

ID Marker	
	Package of 10 plastic strip comprising 10 individual markers which can be placed for easy identification during the use of multiple units.
<b>ID Marker</b>	
CNLB	
CNLN	
CNL2	

# AGENCY APPROVALS & CERTIFICATIONS



## Certification in accordance with:

United States Standard for Industrial Control Equipment - UL 508 and  
Canadian Standard Association for Industrial Control Equipment – C22.2 No. 14.

DRH series conforms to the harmonized EN standard EN/IEC 60947-4-2

## Electromagnetic Compatibility:

IEC 61000-4-2 : Electrostatic Discharge – Level 3  
IEC 61000-4-4 : Electrically Fast Transients – Level 3  
IEC 61000-4-5 : Electrical Surges – Level 3

## Vibration Resistance:

IEC 60068-2-6: Amplitude Range 10-55 Hz, Displacement 0.75mm

## Shock Resistance:

IEC 60068-2-27: Peak Acceleration 15g, Duration 11msec.

# WARNINGS



## RISK OF MATERIAL DAMAGE AND HOT ENCLOSURE

- The product's side panels may be hot, allow the product to cool before touching
- Follow proper mounting instructions including torque values
- Do not allow liquids or foreign objects to enter this product

**Failure to follow these instructions can result in serious injury, or equipment damage.**



## HAZARD OF ELECTRIC SHOCK, EXPLOSION OR ARC FLASH

- Disconnect all power before installing or working with this equipment
- Verify all connections and replace all covers before turning on power

**Failure to follow these instructions will result in death or serious injury.**

Sensata Technologies, Inc. ("Sensata") data sheets are solely intended to assist designers ("Buyers") who are developing systems that incorporate Sensata products (also referred to herein as "components"). Buyer understands and agrees that Buyer remains responsible for using its independent analysis, evaluation and judgment in designing Buyer's systems and products. Sensata data sheets have been created using standard laboratory conditions and engineering practices. Sensata has not conducted any testing other than that specifically described in the published documentation for a particular data sheet. Sensata may make corrections, enhancements, improvements and other changes to its data sheets or components without notice.

Buyers are authorized to use Sensata data sheets with the Sensata component(s) identified in each particular data sheet. HOWEVER, NO OTHER LICENSE, EXPRESS OR IMPLIED, BY ESTOPPEL OR OTHERWISE TO ANY OTHER SENSATA INTELLECTUAL PROPERTY RIGHT, AND NO LICENSE TO ANY THIRD PARTY TECHNOLOGY OR INTELLECTUAL PROPERTY RIGHT, IS GRANTED HEREIN. SENSATA DATA SHEETS ARE PROVIDED "AS IS". SENSATA MAKES NO WARRANTIES OR REPRESENTATIONS WITH REGARD TO THE DATA SHEETS OR USE OF THE DATA SHEETS, EXPRESS, IMPLIED OR STATUTORY, INCLUDING ACCURACY OR COMPLETENESS. SENSATA DISCLAIMS ANY WARRANTY OF TITLE AND ANY IMPLIED WARRANTIES OF MERCHANTABILITY, FITNESS FOR A PARTICULAR PURPOSE, QUIET ENJOYMENT, QUIET POSSESSION, AND NON-INFRINGEMENT OF ANY THIRD PARTY INTELLECTUAL PROPERTY RIGHTS WITH REGARD TO SENSATA DATA SHEETS OR USE THEREOF.

All products are sold subject to Sensata's terms and conditions of sale supplied at [www.sensata.com](http://www.sensata.com) SENSATA ASSUMES NO LIABILITY FOR APPLICATIONS ASSISTANCE OR THE DESIGN OF BUYERS' PRODUCTS. BUYER ACKNOWLEDGES AND AGREES THAT IT IS SOLELY RESPONSIBLE FOR COMPLIANCE WITH ALL LEGAL, REGULATORY AND SAFETY-RELATED REQUIREMENTS CONCERNING ITS PRODUCTS, AND ANY USE OF SENSATA COMPONENTS IN ITS APPLICATIONS, NOTWITHSTANDING ANY APPLICATIONS-RELATED INFORMATION OR SUPPORT THAT MAY BE PROVIDED BY SENSATA.

Mailing Address: Sensata Technologies, Inc., 529 Pleasant Street, Attleboro, MA 02703, USA.

## CONTACT US

### Americas

+1 (877) 502 5500  
sales.crydom@sensata.com  
**Europe, Middle East & Africa**  
+44 (1202) 416170  
ssr-info.eu@sensata.com

### Asia Pacific

sales.isasia@list.sensata.com  
China +86 (21) 2306 1500  
Japan +81 (45) 277 7117  
Korea +82 (31) 601 2004  
India +91 (80) 67920890  
Rest of Asia +886 (2) 27602006  
ext 2808