

LLSD103A~LLSD103C

SMALL SIGNAL SCHOTTKY BARRIES SWITCHING DIODES

VOLTAGE 20 to 40 Volt **CURRENT** 0.35 Ampere

MINI-MELF / LL34 Unit : inch(mm)

FEATURES

- Low Forward Voltage Drop
- Guard Ring Construction for Transient Protection
- Low Reverse Recovery Time
- Low Reverse Capacitance
- Lead free in compliance with EU RoHS 2011/65/EU directive

MECHANICAL DATA

- Case: Molded Glass MINI MELF
- Terminals: Solderable per MIL-STD-750, Method 2026
- Polarity: See Diagram Below
- Approx. Weight: 0.001 ounces, 0.03 grams

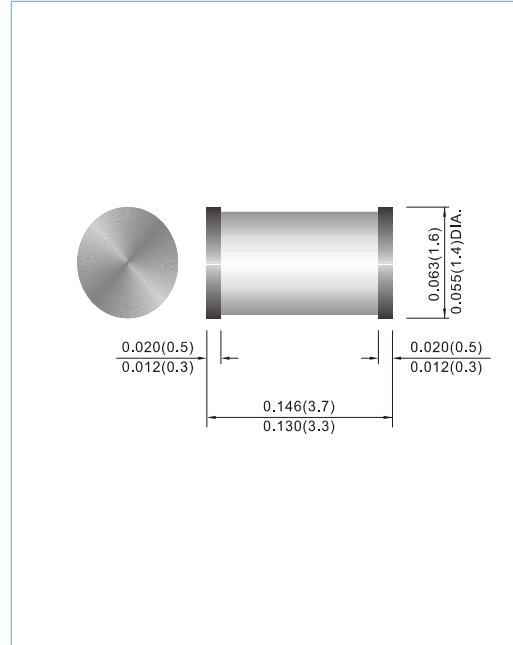

MAXIMUM RATINGS AND ELECTRICAL CHARACTERISTICS (T_J=25°C unless otherwise noted)

PARAMETER	SYMBOL	LLSD103A	LLSD103B	LLSD103C	UNITS
Peak Repetitive Reverse Voltage	V _{RRM}	40	30	20	V
RMS Reverse Voltage	V _{RMS}	28	21	14	V
Max. Average Rectified Current	I _{F(AV)}	350			mA
Peak Forward Surge Current, t ≤ 0.3ms	I _{FSM}	15			A
Power Dissipation Derate Above 25°C	P _D	400			mW
Maximum Forward Voltage, I _F = 20mA I _F = 200mA	V _F	0.37 0.70			V
Maximum Reverse Current	I _R	5 @ 30V	5 @ 20V	5 @ 10V	μA
Typical Junction Capacitance(Note 1)	C _J	50			pF
Typical Reverse Recovery (Note 2)	t _{rr}	10			ns
Typical Thermal Resistance	R _{θJA}	250			°C / W
Storage Temperature Range	T _{STG}	-65 to +175			°C

NOTE:

1. C_J at V_R=0, f=1MHZ
2. From I_F=50mA to I_R=200mA, R_L=100Ω

LLSD103A~LLSD103C

RATING AND CHARACTERISTIC CURVES

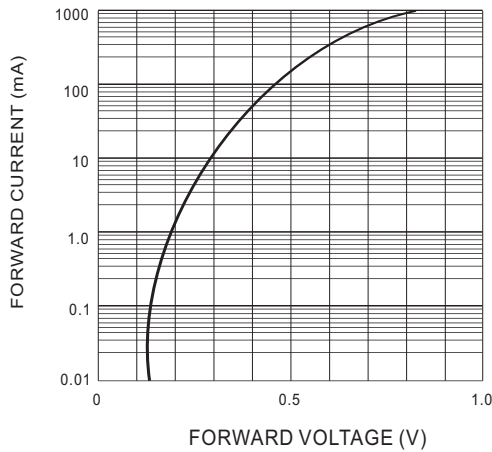

Fig. 1 FORWARD CHARACTERISTICS

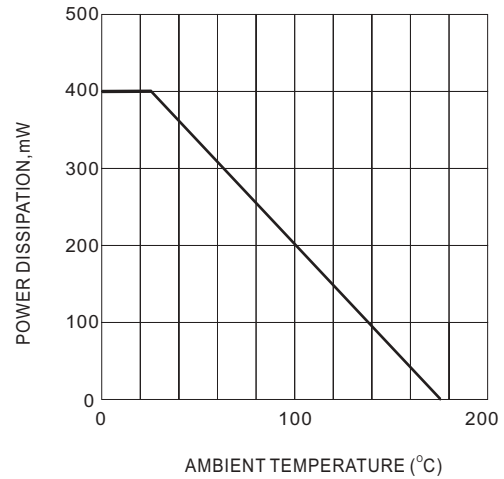

Fig. 2 POWER DISSIPATION DERATING CURVE

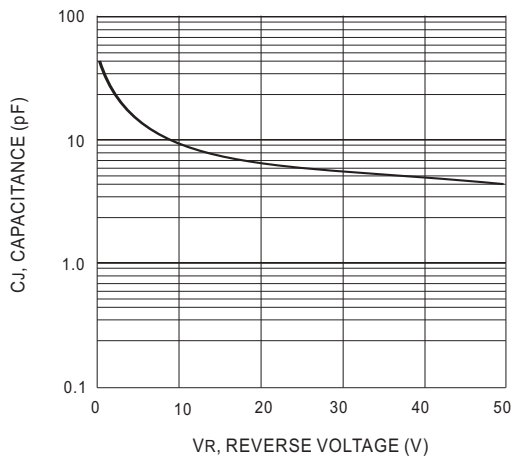

Fig. 3 TYPICAL CAPACITANCE vs REVERSE VOLTAGE

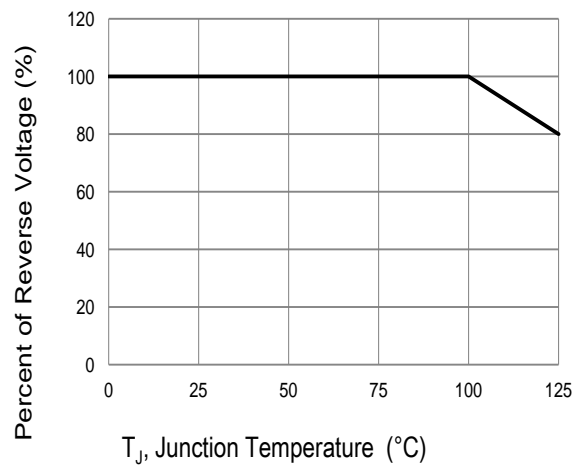
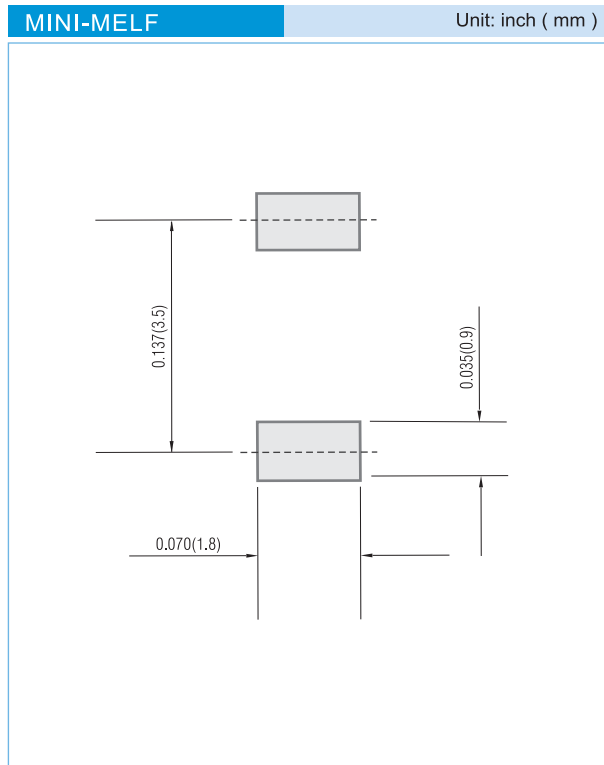

Fig. 4 Operating Temperature Derating Curve

LLSD103A~LLSD103C

MOUNTING PAD LAYOUT



ORDER INFORMATION

- Packing information
 - T/R - 10K per 13" plastic Reel
 - T/R - 2.5K per 7" plastic Reel

LLSD103A~LLSD103C

Part No_packing code_Version

LLSD103A_R1_10001

LLSD103A_R2_10001

For example :

RB500V-40_R2_00001

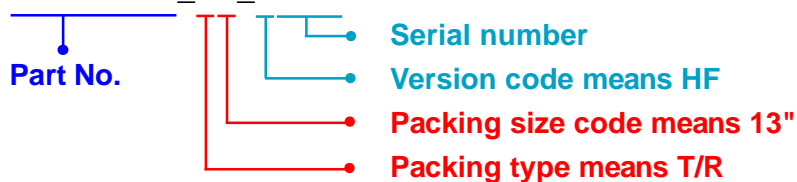

Packing Code XX				Version Code XXXXX		
Packing type	1 st Code	Packing size code	2 nd Code	HF or RoHS	1 st Code	2 nd ~5 th Code
Tape and Ammunition Box (T/B)	A	N/A	0	HF	0	serial number
Tape and Reel (T/R)	R	7"	1	RoHS	1	serial number
Bulk Packing (B/P)	B	13"	2			
Tube Packing (T/P)	T	26mm	X			
Tape and Reel (Right Oriented) (TRR)	S	52mm	Y			
Tape and Reel (Left Oriented) (TRL)	L	PANASERT T/B CATHODE UP (PBCU)	U			
FORMING	F	PANASERT T/B CATHODE DOWN (PBCD)	D			

LLSD103A~LLSD103C

Disclaimer

- Reproducing and modifying information of the document is prohibited without permission from Panjit International Inc..
- Panjit International Inc. reserves the rights to make changes of the content herein the document anytime without notification. Please refer to our website for the latest document.
- Panjit International Inc. disclaims any and all liability arising out of the application or use of any product including damages incidentally and consequentially occurred.
- Panjit International Inc. does not assume any and all implied warranties, including warranties of fitness for particular purpose, non-infringement and merchantability.
- Applications shown on the herein document are examples of standard use and operation. Customers are responsible in comprehending the suitable use in particular applications. Panjit International Inc. makes no representation or warranty that such applications will be suitable for the specified use without further testing or modification.
- The products shown herein are not designed and authorized for equipments requiring high level of reliability or relating to human life and for any applications concerning life-saving or life-sustaining, such as medical instruments, transportation equipment, aerospace machinery et cetera. Customers using or selling these products for use in such applications do so at their own risk and agree to fully indemnify Panjit International Inc. for any damages resulting from such improper use or sale.
- Since Panjit uses lot number as the tracking base, please provide the lot number for tracking when complaining.

Mouser Electronics

Authorized Distributor

Click to View Pricing, Inventory, Delivery & Lifecycle Information:

[Panjit:](#)

[LLSD103C_R1_10001](#) [LLSD103C_R2_10001](#)