

Features	
Switching	Random
Output	Triac or alternistor
Input	DC with constant current control
Applications	Inductive loads with $\cos\phi > 0.65$

Technical data					
WG MMPB 3R - ...	0	1	2	3	4
SSR type	WG A8 6D 03 R	WG A8 6D 05 R	WG A8 8D 05 R	WG A8 10D 05 R	WG A8 12D 05 R
Input circuit					
Control voltage range	3...32 V _{DC}				
Control current max.	42 mA		66 mA		
Turn-off voltage min.	1 V _{DC}				
Input resistance	Constant current				
Output circuit					
Load voltage range	48...280 V _{AC}		24...420 V _{AC}		24...480 V _{AC}
Peak-off state voltage	600 V _{drm}		800 V _{drm}		1000 V _{drm} 1200 V _{drm}
Off-state leakage current	5 mA eff.	8 mA eff.		5 mA eff.	
Load current range	0,05...3 A		0,1...5 A		
Surge current 1 half wave	100 A _{peak}			120 A _{peak}	
I ² t for fusing	50 A ² s			72 A ² s	
On-state voltage	1,6 V _{peak}				
Off-state (static) dv/dt	500 V/μs				
Snubber	47 Ω / 22 nF	47 Ω / 47 nF		47 Ω / 10 nF	
General data					
Turn-on time max.	0,1 ms				
Turn-off time max.	11 ms				
Line frequency range	47...63 Hz				
Isolation volt. between input/output	4.000 V				
Isolation volt. between input-output/base	————				
Isolation resistance	50 MΩ				
Operation temperature	-20...+80 °C				
Recommended varistor	SIOV-S14 K230				
Approvals	UL		————		VDE

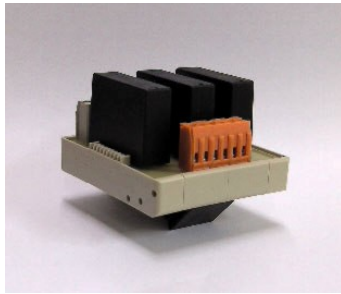

Features

Switching	Zero cross
Output	Triac or alternistor
Input	DC with constant current control
Applications	Resistive and inductive loads with $\cos\phi > 0.85$

Technical data

WG MMPB 3Z - ...	0	1	2	3	4
SSR type	WG A8 6D 03 Z	WG A8 6D 05 Z	WG A8 8D 05 Z	WG A8 10D 05 Z	WG A8 12D 05 Z
Input circuit					
Control voltage range	3...32 V _{DC}				
Control current max.	42 mA		66 mA		
Turn-off voltage min.	1 V _{DC}				
Input resistance	Constant current				
Output circuit					
Load voltage range	24...280 V _{AC}		24...420 V _{AC}		24...480 V _{AC}
Peak-off state voltage	600 V _{drm}		800 V _{drm}		1000 V _{drm} 1200 V _{drm}
Off-state leakage current	5 mA eff.	8 mA eff.		5 mA eff.	
Load current range	0,05...3 A		0,1...5 A		
Surge current 1 half wave	100 A _{peak}			120 A _{peak}	
I ² t for fusing	50 A ² s			72 A ² s	
On-state voltage	1,6 V _{peak}				
Off-state (static) dv/dt	500 V/μs				
Snubber	47 Ω / 22 nF	47 Ω / 47 nF		47 Ω / 10 nF	
General data					
Turn-on time max.	11 ms				
Turn-off time max.	11 ms				
Line frequency range	47...63 Hz				
Isolation volt. between input/output	4.000 V				
Isolation volt. between input-output/base	—————				
Isolation resistance	50 MΩ				
Operation temperature	-20...+80 °C				
Recommended varistor	SIOV-S14 K230				
Approvals	UL		—————		VDE

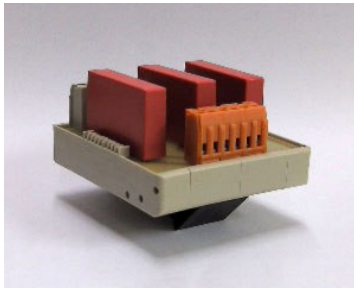

Features

Switching	Direct
Output	MOSFET
Input	DC with constant current control
Applications	Resistive, capacitive and inductive DC loads

Technical data

WG MMPB 3F - ...	5	6	7	8	9
SSR type	WG F8 50 D 08	WG F8 60 D 10	WG F8 100 D 05	WG F8 200 D 03	WG F8 400 D 01
Input circuit					
Control voltage range	3...32 V _{DC}				
Control current max.	75 mA				
Turn-off voltage min.	1 V _{DC}				
Input resistance	Constant current				
Output Circuit					
Load voltage range	1...50 V _{DC}	1...60 V _{DC}	1...100 V _{DC}	1...200 V _{DC}	1...400 V _{DC}
Peak-off-state voltage	50 V _{drm}	60 V _{drm}	100 V _{drm}	200 V _{drm}	400 V _{drm}
Off-state leakage current	0,1 mA eff.				
Load current range	0...8 A	0...10A	0...5 A	0...3 A	0...1,5 A
Surge current 2ms max.	80 A	100 A	50 A	35 A	15 A
On-state resistance max.	36 mΩ	25 mΩ	150 mΩ	360 mΩ	1100 mΩ
General data					
Turn-on time max.	2 ms				
Turn-off time max.	0,1 ms				
PWM frequency max.	250 Hz				
Isolation volt. input to output	1.500 VDC				
Isolation resistance	50 MΩ				
Operating temperature	-20...+80 °C				
Recommend external contact protection for inductive loads	Diode, RC-snubber				
Approvals	_____				

Circuit diagrams

WG MMPB 3Z/R

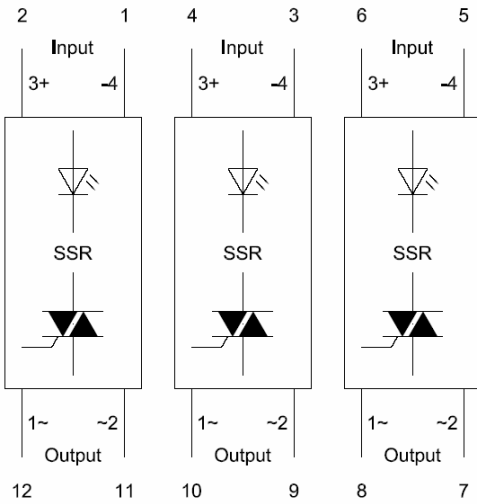

WG MMPB 3F

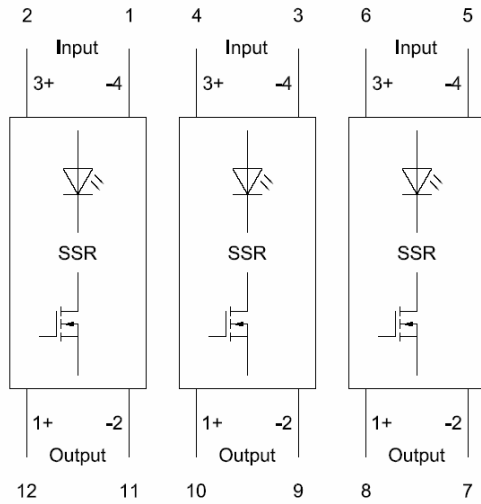

Dimensions in mm

WG MMPB 3Z/R - 0 & WG MMPB 3F

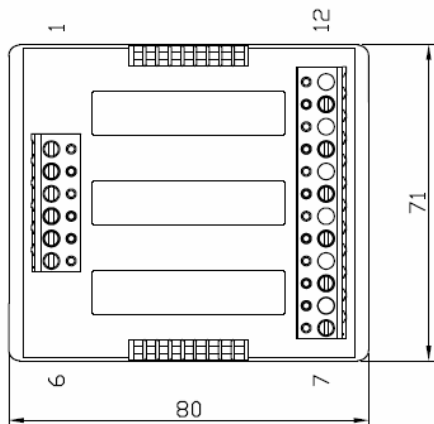
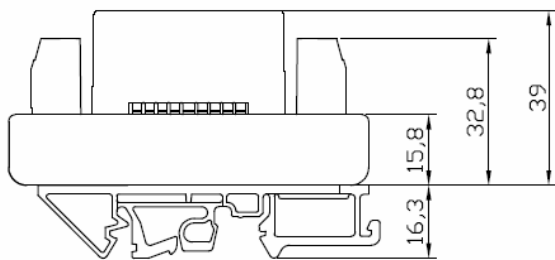

WG MMPB 3Z/R - 1/2/3/4

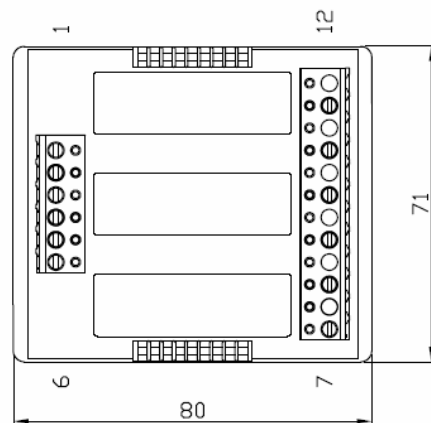
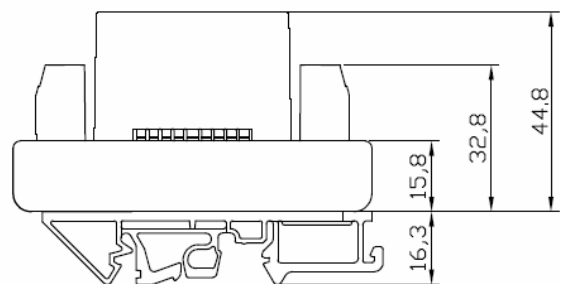

Derating diagrams

WG MMPB 3Z/R - 0

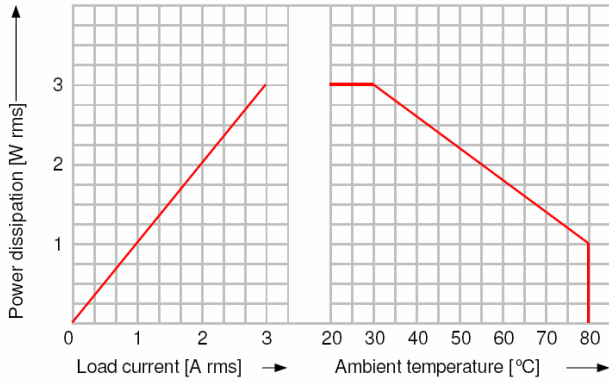

WG MMPB 3Z/R - 1/2/3/4

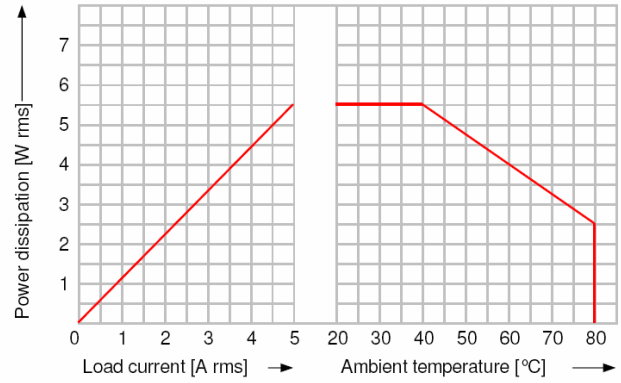

WG MMPB 3F - 5

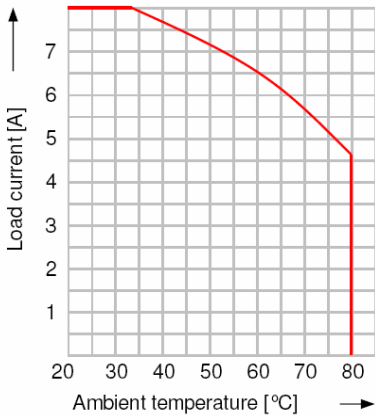

WG MMPB 3F - 6

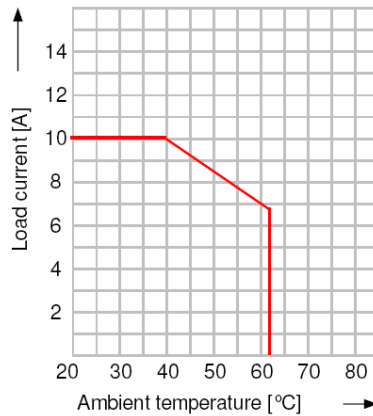

WG MMPB 3F - 7

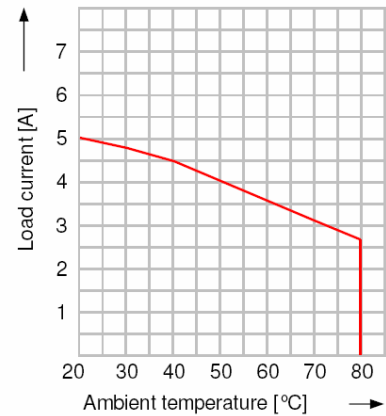

WG MMPB 3F - 8

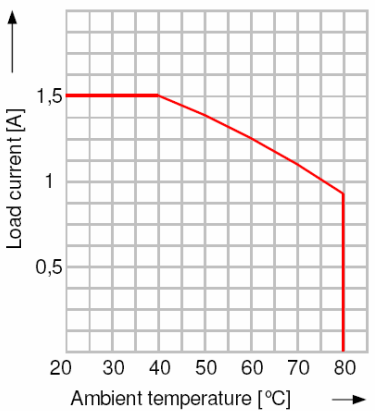

WG MMPB 3F - 9

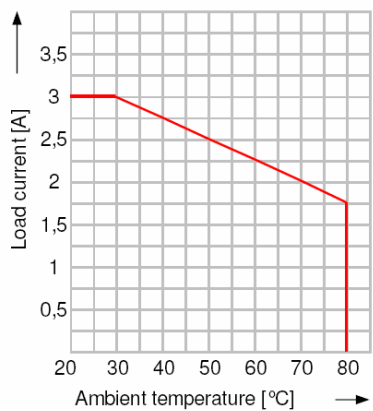

Ordering information

WG MMPB 3R - 0

