

# 512Mb D-die DDR SDRAM Specification

**54 sTSOP-II with Pb-Free (400mil x 441mil)**  
**(RoHS compliant)**

INFORMATION IN THIS DOCUMENT IS PROVIDED IN RELATION TO SAMSUNG PRODUCTS,  
AND IS SUBJECT TO CHANGE WITHOUT NOTICE.

NOTHING IN THIS DOCUMENT SHALL BE CONSTRUED AS GRANTING ANY LICENSE,  
EXPRESS OR IMPLIED, BY ESTOPPEL OR OTHERWISE,

TO ANY INTELLECTUAL PROPERTY RIGHTS IN SAMSUNG PRODUCTS OR TECHNOLOGY. ALL  
INFORMATION IN THIS DOCUMENT IS PROVIDED

ON AS "AS IS" BASIS WITHOUT GUARANTEE OR WARRANTY OF ANY KIND.

1. For updates or additional information about Samsung products, contact your nearest Samsung office.
2. Samsung products are not intended for use in life support, critical care, medical, safety equipment, or similar applications where Product failure could result in loss of life or personal or physical harm, or any military or defense application, or any governmental procurement to which special terms or provisions may apply.

\* Samsung Electronics reserves the right to change products or specification without notice.

**Table of Contents**

**1.0 Key Features .....4**

**2.0 Ordering Information.....4**

**3.0 Operating Frequencies.....4**

**4.0 Pin Description .....5**

**5.0 Package Physical Dimension .....6**

**6.0 Block Diagram (16Mbit x8 I/O x4 Banks) .....7**

**7.0 Input/Output Function Description .....8**

**8.0 Command Truth Table.....9**

**9.0 General Description.....10**

**10.0 Absolute Maximum Rating .....10**

**11.0 DC Operating Conditions .....10**

**12.0 DDR SDRAM Spec Items & Test Conditions .....11**

**13.0 Input/Output Capacitance .....11**

**14.0 Detailed test condition for DDR SDRAM IDD1 & IDD7A .....12**

**15.0 DDR SDRAM IDD spec table .....13**

**16.0 AC Operating Conditions .....14**

**17.0 AC Overshoot/Undershoot specification for Address and Control Pins.....14**

**18.0 Overshoot/Undershoot specification for Data, Strobe and Mask Pins.....15**

**19.0 AC Timing Parameters & Specifications .....16**

**20.0 System Characteristics for DDR SDRAM .....17**

**21.0 Component Notes .....18**

**22.0 System Notes .....20**

**23.0 IBIS : I/V Characteristics for Input and Output Buffers .....21**

**Revision History**

Revision	Month	Year	History
0.0	April	2005	- First version for internal review
0.1	June	2005	- Changed Mater format

# DDR SDRAM 512Mb D-die (x8)

## 1.0 Key Features

- VDD : 2.5V ± 0.2V, VDDQ : 2.5V ± 0.2V for DDR266, 333
- VDD : 2.6V ± 0.1V, VDDQ : 2.6V ± 0.1V for DDR400
- Double-data-rate architecture; two data transfers per clock cycle
- Bidirectional data strobe [DQS] (x4,x8)
- Four banks operation
- Differential clock inputs(CK and  $\overline{CK}$ )
- DLL aligns DQ and DQS transition with CK transition
- MRS cycle with address key programs
  - . Read latency : DDR266(2, 2.5 Clock), DDR333(2.5 Clock), DDR400(3 Clock)
  - . Burst length (2, 4, 8)
  - . Burst type (sequential & interleave)
- All inputs except data & DM are sampled at the positive going edge of the system clock(CK)
- Data I/O transactions on both edges of data strobe
- Edge aligned data output, center aligned data input
- DM for write masking only (x4, x8)
- Auto & Self refresh
- 7.8us refresh interval(8K/64ms refresh)
- Maximum burst refresh cycle : 8
- 54pin sTSOP(II)-400 **Pb-Free** package
- **RoHS compliant**

## 2.0 Ordering Information

Part No.	Org.	Max Freq.	Interface	Package
K4H510838D-VC/LCC	64M x 8	CC(DDR400@CL=3)	SSTL2	54pin sTSOP II
K4H510838D-VC/LB3		B3(DDR333@CL=2.5)		
K4H510838D-VC/LA2		A2(DDR266@CL=2)		
K4H510838D-VC/LB0		B0(DDR266@CL=2.5)		

## 3.0 Operating Frequencies

	CC(DDR400@CL=3)	B3(DDR333@CL=2.5)	A2(DDR266@CL=2.0)	B0(DDR266@CL=2.5)
Speed @CL2	-	133MHz	133MHz	100MHz
Speed @CL2.5	166MHz	166MHz	133MHz	133MHz
Speed @CL3	200MHz	-	-	-
CL-tRCD-tRP	3-3-3	2.5-3-3	2-3-3	2.5-3-3

4.0 Pin Description

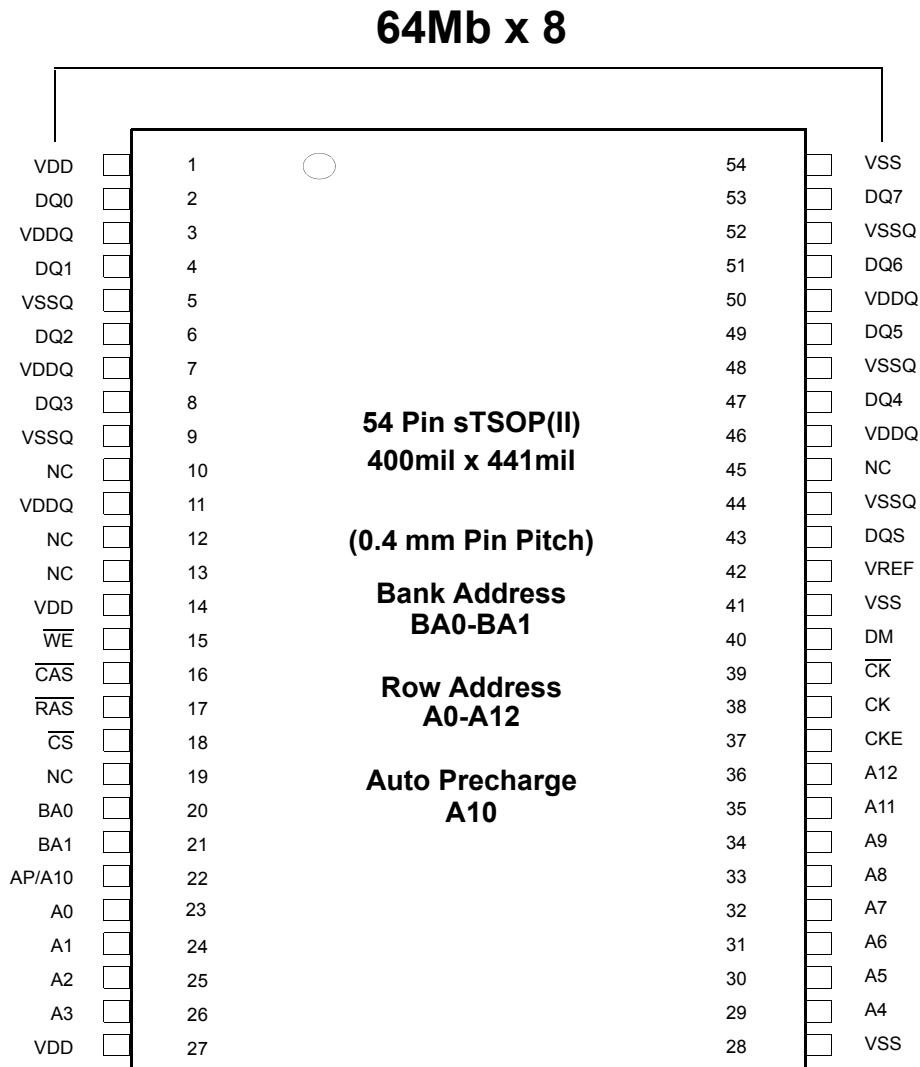

512Mb sTSOP(II)-400 Package Pinout

Organization	Row Address	Column Address
64Mx8	A0~A12	A0-A9, A11

DM is internally loaded to match DQ and DQS identically.

**Row & Column address configuration**

5.0 Package Physical Dimension

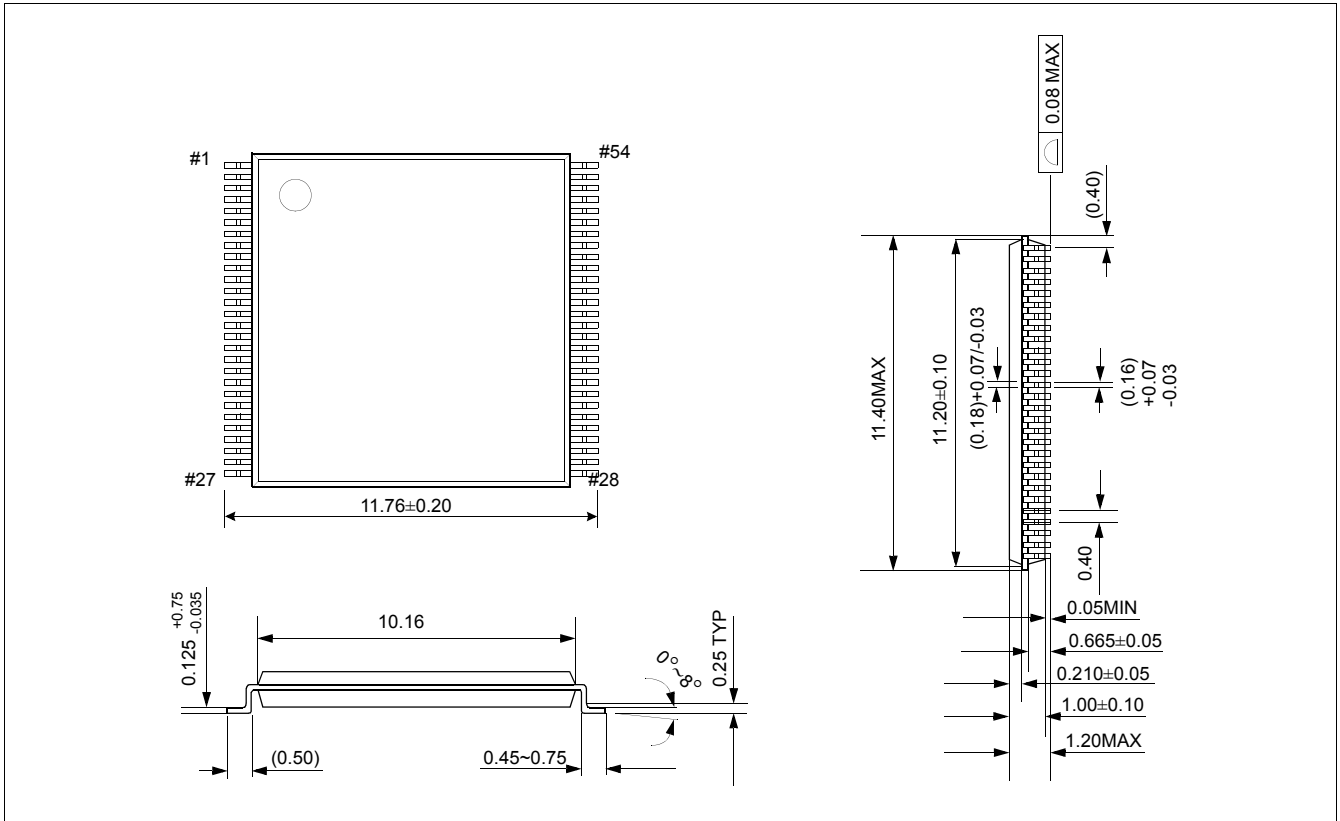

54pin sTSOPII-400 / Package dimension

# DDR SDRAM 512Mb D-die (x8)

## 6.0 Block Diagram (16Mb x 8 I/O x4 Banks)

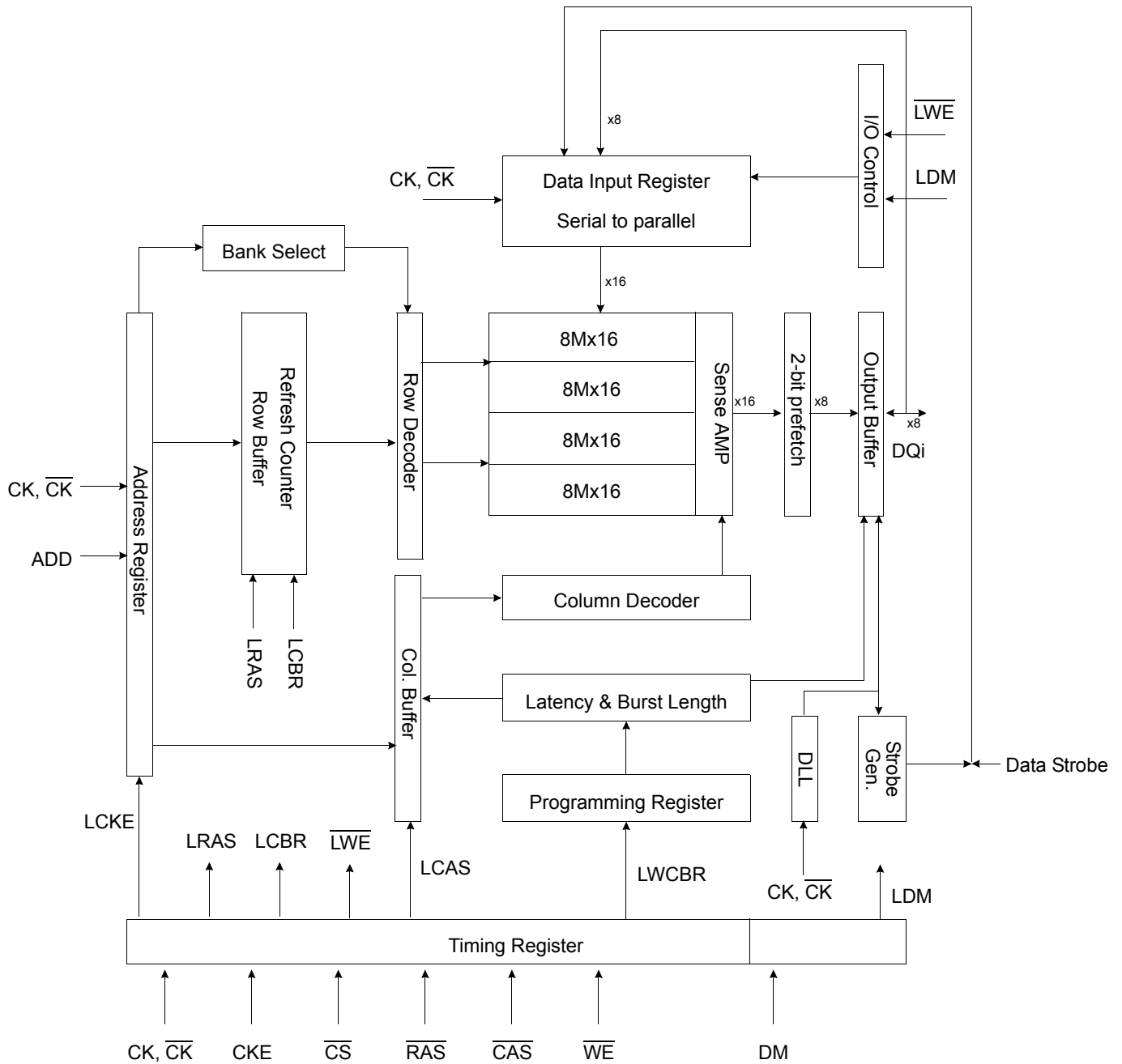

7.0 Input/Output Function Description

SYMBOL	TYPE	DESCRIPTION
CK, $\overline{CK}$	Input	Clock : CK and $\overline{CK}$ are differential clock inputs. All address and control input signals are sampled on the positive edge of CK and negative edge of $\overline{CK}$ . Output (read) data is referenced to both edges of CK. Internal clock signals are derived from CK/ $\overline{CK}$ .
CKE	Input	Clock Enable : CKE HIGH activates, and CKE LOW deactivates internal clock signals, and device input buffers and output drivers. Taking CKE Low provides PRECHARGE POWER-DOWN and SELF REFRESH operation (all banks idle), or ACTIVE POWER-DOWN (row ACTIVE in any bank). CKE is synchronous for POWER-DOWN entry and exit, and for SELF REFRESH entry. CKE is asynchronous for SELF REFRESH exit, and for output disable. CKE must be maintained high throughout READ and WRITE accesses. Input buffers, excluding CK, $\overline{CK}$ and CKE are disabled during POWER-DOWN. Input buffers, excluding CKE are disabled during SELF REFRESH. CKE is an SSTL_2 input, but will detect an LVCMOS Low level after V <sub>DD</sub> is applied upon 1st power up, After V <sub>REF</sub> has become stable during the power on and initialization sequence, it must be maintained for proper operation of the CKE receiver. For proper SELF-REFRESH entry and exit, V <sub>REF</sub> must be maintained to this input.
$\overline{CS}$	Input	Chip Select : $\overline{CS}$ enables(registered LOW) and disables(registered HIGH) the command decoder. All commands are masked when $\overline{CS}$ is registered HIGH. $\overline{CS}$ provides for external bank selection on systems with multiple banks. $\overline{CS}$ is considered part of the command code.
$\overline{RAS}$ , $\overline{CAS}$ , $\overline{WE}$	Input	Command Inputs : $\overline{RAS}$ , $\overline{CAS}$ and $\overline{WE}$ (along with $\overline{CS}$ ) define the command being entered.
LDM,(UDM)	Input	Input Data Mask : DM is an input mask signal for write data. Input data is masked when DM is sampled HIGH along with that input data during a WRITE access. DM is sampled on both edges of DQS. Although DM pins are input only, the DM loading matches the DQ and DQS loading. For the x16, LDM corresponds to the data on DQ0~D7 ; UDM corresponds to the data on DQ8~DQ15. DM may be driven high, low, or floating during READs.
BA0, BA1	Input	Bank Address Inputs : BA0 and BA1 define to which bank an ACTIVE, READ, WRITE or PRECHARGE command is being applied.
A [0 : 12]	Input	Address Inputs : Provide the row address for ACTIVE commands, and the column address and AUTO PRECHARGE bit for READ/WRITE commands, to select one location out of the memory array in the respective bank. A10 is sampled during a PRECHARGE command to determine whether the PRECHARGE applies to one bank (A10 LOW) or all banks (A10 HIGH). If only one bank is to be precharged, the bank is selected by BA0, BA1. The address inputs also provide the op-code during a MODE REGISTER SET command. BA0 and BA1 define which mode register is loaded during the MODE REGISTER SET command (MRS or EMRS).
DQ	I/O	Data Input/Output : Data bus
LDQS,(U)DQS	I/O	Data Strobe : Output with read data, input with write data. Edge-aligned with read data, centered in write data. Used to capture write data. For the x16, LDQS corresponds to the data on DQ0~D7 ; UDQS corresponds to the data on DQ8~DQ15
NC	-	No Connect : No internal electrical connection is present.
VDDQ	Supply	DQ Power Supply : +2.5V ± 0.2V. (+2.6V ±0.1V for DDR400)
VSSQ	Supply	DQ Ground.
VDD	Supply	Power Supply : +2.5V ± 0.2V. (+2.6V ±0.1V for DDR400)
VSS	Supply	Ground.
VREF	Input	SSTL_2 reference voltage.



## 8.0 Command Truth Table

(V=Valid, X=Don't Care, H=Logic High, L=Logic Low)

COMMAND		CKEn-1	CKEn	$\overline{CS}$	$\overline{RAS}$	$\overline{CAS}$	$\overline{WE}$	BA0,1	A10/AP	A0 ~ A9, A11 ~ A12	Note	
Register	Extended MRS	H	X	L	L	L	L	OP CODE			1, 2	
Register	Mode Register Set	H	X	L	L	L	L	OP CODE			1, 2	
Refresh	Auto Refresh	H	H	L	L	L	H	X			3	
	Entry		L								3	
	Self Refresh	L	H	L	H	H	H	X			3	
				Exit	H	X	X			X		3
Bank Active & Row Addr.		H	X	L	L	H	H	V	Row Address			
Read & Column Address	Auto Precharge Disable	H	X	L	H	L	H	V	L	Column Address		4
	Auto Precharge Enable								H			4
Write & Column Address	Auto Precharge Disable	H	X	L	H	L	L	V	L	Column Address		4
	Auto Precharge Enable								H			4, 6
Burst Stop		H	X	L	H	H	L	X			7	
Precharge	Bank Selection	H	X	L	L	H	L	V	L	X		
	All Banks							X	H			5
Active Power Down	Entry	H	L	H	X	X	X	X				
				L	V	V	V					
Precharge Power Down Mode	Entry	H	L	H	X	X	X	X				
				L	H	H	H					
	Exit	L	H	H	X	X	X					
				L	V	V	V					
DM(UDM/LDM for x16 only)		H		X				X			8	
No operation (NOP) : Not defined		H	X	H	X	X	X	X				9
				L	H	H	H					9

Note :

- OP Code : Operand Code. A<sub>0</sub> ~ A<sub>12</sub> & BA<sub>0</sub> ~ BA<sub>1</sub> : Program keys. (@EMRS/MRS)
- EMRS/MRS can be issued only at all banks precharge state.  
A new command can be issued 2 clock cycles after EMRS or MRS.
- Auto refresh functions are same as the CBR refresh of DRAM.  
The automatical precharge without row precharge command is meant by "Auto".  
Auto/self refresh can be issued only at all banks precharge state.
- BA<sub>0</sub> ~ BA<sub>1</sub> : Bank select addresses.  
If both BA<sub>0</sub> and BA<sub>1</sub> are "Low" at read, write, row active and precharge, bank A is selected.  
If BA<sub>0</sub> is "High" and BA<sub>1</sub> is "Low" at read, write, row active and precharge, bank B is selected.  
If BA<sub>0</sub> is "Low" and BA<sub>1</sub> is "High" at read, write, row active and precharge, bank C is selected.  
If both BA<sub>0</sub> and BA<sub>1</sub> are "High" at read, write, row active and precharge, bank D is selected.
- If A<sub>10</sub>/AP is "High" at row precharge, BA<sub>0</sub> and BA<sub>1</sub> are ignored and all banks are selected.
- During burst write with auto precharge, new read/write command can not be issued.  
Another bank read/write command can be issued after the end of burst.  
New row active of the associated bank can be issued at t<sub>RP</sub> after the end of burst.
- Burst stop command is valid at every burst length.
- DM(x4/8) sampled at the rising and falling edges of the DQS and Data-in are masked at the both edges (Write DM latency is 0).  
UDM/LDM(x16 only) sampled at the rising and falling edges of the UDQS/LDQS and Data-in are masked at the both edges (Write UDM/LDM latency is 0).
- This combination is not defined for any function, which means "No Operation(NOP)" in DDR SDRAM.

# DDR SDRAM 512Mb D-die (x8)

## 16M x 8Bit x 4 Banks Double Data Rate SDRAM

### 9.0 General Description

The K4H510838D is 536,870,912 bits of double data rate synchronous DRAM organized as 4x 16,777,216 words by 8bits, fabricated with SAMSUNG's high performance CMOS technology. Synchronous features with Data Strobe allow extremely high performance up to 400Mb/s per pin. I/O transactions are possible on both edges of DQS. Range of operating frequencies, programmable burst length and programmable latencies allow the device to be useful for a variety of high performance memory system applications.

### 10.0 Absolute Maximum Rating

Parameter	Symbol	Value	Unit
Voltage on any pin relative to V <sub>SS</sub>	V <sub>IN</sub> , V <sub>OUT</sub>	-0.5 ~ 3.6	V
Voltage on V <sub>DD</sub> & V <sub>DDQ</sub> supply relative to V <sub>SS</sub>	V <sub>DD</sub> , V <sub>DDQ</sub>	-1.0 ~ 3.6	V
Storage temperature	T <sub>STG</sub>	-55 ~ +150	°C
Power dissipation	P <sub>D</sub>	1.5	W
Short circuit current	I <sub>OS</sub>	50	mA

Note : Permanent device damage may occur if ABSOLUTE MAXIMUM RATINGS are exceeded.

Functional operation should be restricted to recommend operation condition.

Exposure to higher than recommended voltage for extended periods of time could affect device reliability.

### 11.0 DC Operating Conditions Recommended operating conditions(Voltage referenced to V<sub>SS</sub>=0V, T<sub>A</sub>=0 to 70°C)

Parameter	Symbol	Min	Max	Unit	Note
Supply voltage(for device with a nominal V <sub>DD</sub> of 2.5V for DDR266/333)	V <sub>DD</sub>	2.3	2.7	V	
Supply voltage(for device with a nominal V <sub>DD</sub> of 2.6V for DDR400)	V <sub>DD</sub>	2.5	2.7	V	
I/O Supply voltage(for device with a nominal V <sub>DD</sub> of 2.5V for DDR266/333)	V <sub>DDQ</sub>	2.3	2.7	V	
I/O Supply voltage(for device with a nominal V <sub>DD</sub> of 2.5V for DDR400)	V <sub>DDQ</sub>	2.5	2.7	V	
I/O Reference voltage	V <sub>REF</sub>	0.49*V <sub>DDQ</sub>	0.51*V <sub>DDQ</sub>	V	1
I/O Termination voltage(system)	V <sub>TT</sub>	V <sub>REF</sub> -0.04	V <sub>REF</sub> +0.04	V	2
Input logic high voltage	V <sub>IH</sub> (DC)	V <sub>REF</sub> +0.15	V <sub>DDQ</sub> +0.3	V	
Input logic low voltage	V <sub>IL</sub> (DC)	-0.3	V <sub>REF</sub> -0.15	V	
Input Voltage Level, CK and $\overline{\text{CK}}$ inputs	V <sub>IN</sub> (DC)	-0.3	V <sub>DDQ</sub> +0.3	V	
Input Differential Voltage, CK and $\overline{\text{CK}}$ inputs	V <sub>ID</sub> (DC)	0.36	V <sub>DDQ</sub> +0.6	V	3
V-I Matching: Pullup to Pulldown Current Ratio	V <sub>I</sub> (Ratio)	0.71	1.4	-	4
Input leakage current	I <sub>I</sub>	-2	2	uA	
Output leakage current	I <sub>OZ</sub>	-5	5	uA	
Output High Current(Normal strength driver) ;V <sub>OUT</sub> = V <sub>TT</sub> + 0.84V	I <sub>OH</sub>	-16.8		mA	
Output High Current(Normal strength driver) ;V <sub>OUT</sub> = V <sub>TT</sub> - 0.84V	I <sub>OL</sub>	16.8		mA	
Output High Current(Half strength driver) ;V <sub>OUT</sub> = V <sub>TT</sub> + 0.45V	I <sub>OH</sub>	-9		mA	
Output High Current(Half strength driver) ;V <sub>OUT</sub> = V <sub>TT</sub> - 0.45V	I <sub>OL</sub>	9		mA	

Note :

- V<sub>REF</sub> is expected to be equal to 0.5\*V<sub>DDQ</sub> of the transmitting device, and to track variations in the dc level of same. Peak-to-peak noise on V<sub>REF</sub> may not exceed +/-2% of the dc value.
- V<sub>TT</sub> is not applied directly to the device. V<sub>TT</sub> is a system supply for signal termination resistors, is expected to be set equal to V<sub>REF</sub>, and must track variations in the DC level of V<sub>REF</sub>
- V<sub>ID</sub> is the magnitude of the difference between the input level on CK and the input level on  $\overline{\text{CK}}$ .
- The ratio of the pullup current to the pulldown current is specified for the same temperature and voltage, over the entire temperature and voltage range, for device drain to source voltages from 0.25V to 1.0V. For a given output, it represents the maximum difference between pullup and pulldown drivers due to process variation. The full variation in the ratio of the maximum to minimum pullup and pulldown current will not exceed 1.7 for device drain to source voltages from 0.1 to 1.0.

# DDR SDRAM 512Mb D-die (x8)

## 12.0 DDR SDRAM Spec Items & Test Conditions

Conditions	Symbol
<b>Operating current - One bank Active-Precharge;</b> tRC=tRCmin; tCK=10ns for DDR200, tCK=7.5ns for DDR266, 6ns for DDR333, 5ns for DDR400; DQ,DM and DQS inputs changing once per clock cycle; address and control inputs changing once every two clock cycles.	<b>IDD0</b>
<b>Operating current - One bank operation ;</b> One bank open, BL=4, Reads - Refer to the following page for detailed test condition	<b>IDD1</b>
<b>Precharge power-down standby current;</b> All banks idle; power - down mode; CKE = <VIL(max); tCK=10ns for DDR200,tCK=7.5ns for DDR266, 6ns for DDR333, 5ns for DDR400; Vin = Vref for DQ,DQS and DM.	<b>IDD2P</b>
<b>Precharge Floating standby current;</b> CS# > =VIH(min);All banks idle; CKE > = VIH(min); tCK=10ns for DDR200,tCK=7.5ns for DDR266, 6ns for DDR333, 5ns for DDR400; Address and other control inputs changing once per clock cycle; Vin = Vref for DQ,DQS and DM	<b>IDD2F</b>
<b>Precharge Quiet standby current;</b> CS# > = VIH(min); All banks idle; CKE > = VIH(min); tCK=10ns for DDR200, tCK=7.5ns for DDR266, 6ns for DDR333, 5ns for DDR400; Address and other control inputs stable at >= VIH(min) or <=VIL(max); Vin = Vref for DQ ,DQS and DM	<b>IDD2Q</b>
<b>Active power - down standby current ;</b> one bank active; power-down mode; CKE=< VIL (max); tCK=10ns for DDR200,tCK=7.5ns for DDR266, 6ns for DDR333, 5ns for DDR400; Vin = Vref for DQ,DQS and DM	<b>IDD3P</b>
<b>Active standby current;</b> CS# >= VIH(min); CKE>=VIH(min); one bank active; active - precharge; tRC=tRASmax; tCK=10ns for DDR200,tCK=7.5ns for DDR266, 6ns for DDR333, 5ns for DDR400; DQ, DQS and DM inputs changing twice per clock cycle; address and other control inputs changing once per clock cycle	<b>IDD3N</b>
<b>Operating current - burst read;</b> Burst length = 2; reads; contiguous burst; One bank active; address and control inputs changing once per clock cycle; CL=2 at tCK=10ns for DDR200, CL=2 at 7.5ns for DDR266(A2), CL=2.5 at tCK=7.5ns for DDR266(B0), tCK=6ns for DDR333, CL=3 at tCK=5ns for DDR400; 50% of data changing on every transfer; Iout = 0 mA	<b>IDD4R</b>
<b>Operating current - burst write;</b> Burst length = 2; writes; continuous burst; One bank active address and control inputs changing once per clock cycle; CL=2 at tCK=10ns for DDR200, CL=2 at tCK=7.5ns for DDR266(A2), CL=2.5 at tCK=7.5ns for DDR266(B0), 6ns for DDR333, 5ns for DDR400; DQ, DM and DQS inputs changing twice per clock cycle, 50% of input data changing at every burst	<b>IDD4W</b>
<b>Auto refresh current;</b> tRC = tRFC(min) which is 12*tCK for DDR200 at tCK=10ns; 16*tCK for DDR266 at tCK=7.5ns; 20*tCK for DDR333 at tCK=6ns, 24*tCK for DDR400 at tCK=5ns; distributed refresh	<b>IDD5</b>
<b>Self refresh current;</b> CKE = < 0.2V; External clock on; tCK=10ns for DDR200, tCK=7.5ns for DDR266, 6ns for DDR333, 5ns for DDR400.	<b>IDD6</b>
<b>Operating current - Four bank operation ;</b> Four bank interleaving with BL=4 -Refer to the following page for detailed test condition	<b>IDD7A</b>

## 13.0 Input/Output Capacitance

( TA= 25°C, f=100MHz)

Parameter	Symbol	Min	Max	DeltaCap(max)	Unit	Note
Input capacitance (A0 ~ A12, BA0 ~ BA1, CKE, $\overline{CS}$ , $\overline{RAS}$ , $\overline{CAS}$ , $\overline{WE}$ )	CIN1	2	3	0.5	pF	4
Input capacitance( CK, $\overline{CK}$ )	CIN2	2	3	0.25	pF	4
Data & DQS input/output capacitance	COUT	4	5	0.5	pF	1,2,3,4
Input capacitance(DM for x4/8, UDM/LDM for x16)	CIN3	4	5		pF	1,2,3,4

Note :

- These values are guaranteed by design and are tested on a sample basis only.
- Although DM is an input -only pin, the input capacitance of this pin must model the input capacitance of the DQ and DQS pins. This is required to match signal propagation times of DQ, DQS, and DM in the system.
- Unused pins are tied to ground.
- This parameter is sampled. For DDR266 and DDR333 VDDQ = +2.5V +0.2V, VDD = +3.3V +0.3V or +0.25V+0.2V. For DDR400, VDDQ = +2.6V +0.1V, VDD = +2.6V +0.1V. For all devices, f=100MHz, tA=25°C, Vout(dc) = VDDQ/2, Vout(peak to peak) = 0.2V. DM inputs are grouped with I/O pins - reflecting the fact that they are matched in loading (to facilitate trace matching at the board level).

## 14.0 Detailed test condition for DDR SDRAM IDD1 & IDD7A

### IDD1 : Operating current: One bank operation

1. Typical Case: For DDR200,266,333: Vdd = 2.5V, T=25°C; For DDR400: Vdd=2.6V,T=25°C  
Worst Case : Vdd = 2.7V, T= 10°C
2. Only one bank is accessed with tRC(min), Burst Mode, Address and Control inputs on NOP edge are changing once per clock cycle. Iout = 0mA
3. Timing patterns
  - B0(133Mhz, CL=2.5) : tCK = 7.5ns, CL=2.5, BL=4, tRCD = 3\*tCK, tRC = 9\*tCK, tRAS = 6\*tCK  
Read : A0 N N R0 N N P0 N N A0 N - repeat the same timing with random address changing  
\*50% of data changing at every burst
  - A2 (133Mhz, CL=2) : tCK = 7.5ns, CL=2, BL=4, tRCD = 3\*tCK, tRC = 9\*tCK, tRAS = 6\*tCK  
Read : A0 N N R0 N N P0 N N A0 N - repeat the same timing with random address changing  
\*50% of data changing at every burst
  - B3(166Mhz, CL=2.5) : tCK=6ns, CL=2.5, BL=4, tRCD=3\*tCK, tRC = 10\*tCK, tRAS=7\*tCK  
Read : A0 N N R0 N N P0 N N A0 N - repeat the same timing with random address changing  
\*50% of data changing at every burst
  - CC(200Mhz,CL = 3) : tCK = 5ns, CL = 3, BL = 4, tRCD = 3\*tCK , tRC = 11\*tCK, tRAS = 8\*tCK  
Read : A0 N N R0 N N N N P0 N N - repeat the same timing with random address changing  
\*50% of data changing at every transfer

Legend : A=Activate, R=Read, W=Write, P=Precharge, N=DESELECT

### IDD7A : Operating current: Four bank operation

1. Typical Case: For DDR200,266,333: Vdd = 2.5V, T=25°C; For DDR400: Vdd=2.6V,T=25°C  
Worst Case : Vdd = 2.7V, T= 10°C
2. Four banks are being interleaved with tRC(min), Burst Mode, Address and Control inputs on NOP edge are not changing. Iout = 0mA
4. Timing patterns
  - B0(133Mhz, CL=2.5) : tCK = 7.5ns, CL=2.5, BL=4, tRRD = 2\*tCK, tRCD = 3\*tCK, Read with autoprecharge  
Read : A0 N A1 R0 A2 R1 A3 R2 N R3 A0 N A1 R0 - repeat the same timing with random address changing  
\*50% of data changing at every burst
  - A2(133Mhz, CL=2) : tCK = 7.5ns, CL=2, BL=4, tRRD = 2\*tCK, tRCD = 3\*tCK, Read with autoprecharge  
Read : A0 N A1 R0 A2 R1 A3 R2 N R3 A0 N A1 R0 - repeat the same timing with random address changing  
\*50% of data changing at every burst
  - B3(166Mhz,CL=2.5) : tCK=6ns, CL=2.5, BL=4, tRRD=2\*tCK, tRCD=3\*tCK, Read with autoprecharge  
Read : A0 N A1 R0 A2 R1 A3 R2 N R3 A0 N A1 R0 - repeat the same timing with random address changing  
\*50% of data changing at every burst
  - CC(200Mhz,CL = 3) : tCK = 5ns, CL = 3, BL = 4, tRCD = 3\*tCK , tRC = 11\*tCK, tRAS = 8\*tCK  
Read : A0 N N R0 N N N N P0 N N - repeat the same timing with random address changing  
\*50% of data changing at every transfer

Legend : A=Activate, R=Read, W=Write, P=Precharge, N=DESELECT

15.0 DDR SDRAM IDD spec table

(V<sub>DD</sub>=2.7V, T = 10°C)

Symbol	64Mx8 (K4H510838D)				Unit	Notes
	CC(DDR400@CL=3)	B3(DDR333@CL=2.5)	A2(DDR266@CL=2.0)	B0(DDR266@CL=2.5)		
IDD0	120	105	95	95	mA	
IDD1	150	135	125	125	mA	
IDD2P	5	5	5	5	mA	
IDD2F	30	30	30	30	mA	
IDD2Q	25	25	25	25	mA	
IDD3P	45	30	30	30	mA	
IDD3N	60	45	45	45	mA	
IDD4R	155	140	125	125	mA	
IDD4W	175	150	130	130	mA	
IDD5	220	205	195	195	mA	
IDD6	Normal	5	5	5	mA	
	Low power	3	3	3	mA	Optional
IDD7A	385	360	325	325	mA	

16.0 AC Operating Conditions

Parameter/Condition	Symbol	Min	Max	Unit	Note
Input High (Logic 1) Voltage, DQ, DQS and DM signals	VIH(AC)	VREF + 0.31		V	
Input Low (Logic 0) Voltage, DQ, DQS and DM signals.	VIL(AC)		VREF - 0.31	V	
Input Differential Voltage, CK and /CK inputs	VID(AC)	0.7	VDDQ+0.6	V	1
Input Crossing Point Voltage, CK and /CK inputs	VIX(AC)	0.5*VDDQ-0.2	0.5*VDDQ+0.2	V	2

Note :  
 1. VID is the magnitude of the difference between the input level on CK and the input level on /CK.  
 2. The value of VIX is expected to equal 0.5\*VDDQ of the transmitting device and must track variations in the dc level of the same.

17.0 AC Overshoot/Undershoot specification for Address and Control Pins

Parameter	Specification		
	DDR400	DDR333	DDR200/266
Maximum peak amplitude allowed for overshoot	TBD	TBD	1.5 V
Maximum peak amplitude allowed for undershoot	TBD	TBD	1.5 V
The area between the overshoot signal and VDD must be less than or equal to	TBD	TBD	4.5 V-ns
The area between the undershoot signal and GND must be less than or equal to	TBD	TBD	4.5 V-ns

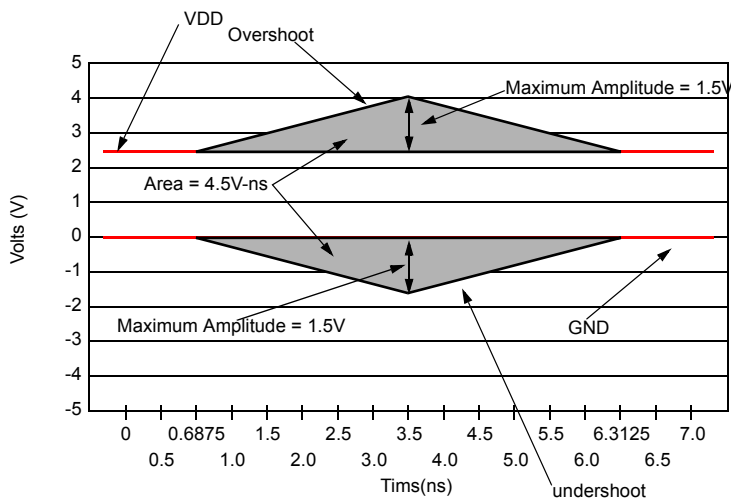

AC overshoot/Undershoot Definition

18.0 Overshoot/Undershoot specification for Data, Strobe and Mask Pins

Parameter	Specification		
	DDR400	DDR333	DDR200/266
Maximum peak amplitude allowed for overshoot	TBD	TBD	1.2 V
Maximum peak amplitude allowed for undershoot	TBD	TBD	1.2 V
The area between the overshoot signal and VDD must be less than or equal to	TBD	TBD	2.4 V-ns
The area between the undershoot signal and GND must be less than or equal to	TBD	TBD	2.4 V-ns

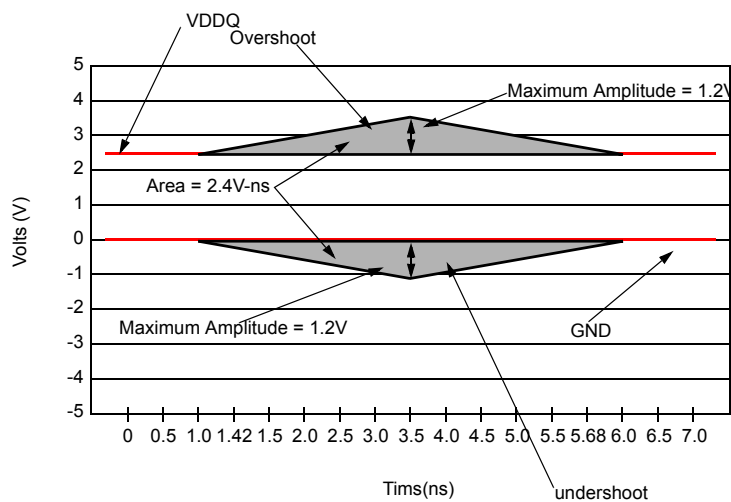

DQ/DM/DQS AC overshoot/Undershoot Definition

# DDR SDRAM 512Mb D-die (x8)

## 19.0 AC Timing Parameters & Specifications

Parameter	Symbol	CC (DDR400@CL=3.0)		B3 (DDR333@CL=2.5)		A2 (DDR266@CL=2.0)		B0 (DDR266@CL=2.5)		Unit	Note	
		Min	Max	Min	Max	Min	Max	Min	Max			
Row cycle time	tRC	55		60		65		65		ns		
Refresh row cycle time	tRFC	70		72		75		75		ns		
Row active time	tRAS	40	70K	42	70K	45	70K	45	70K	ns		
RAS to CAS delay	tRCD	15		18		20		20		ns		
Row precharge time	tRP	15		18		20		20		ns		
Row active to Row active delay	tRRD	10		12		15		15		ns		
Write recovery time	tWR	15		15		15		15		ns		
Last data in to Read command	tWTR	2		1		1		1		tCK		
Clock cycle time	tCK	CL=2.0	-	-	7.5	12	7.5	12	10	12	ns	
		CL=2.5	6	12	6	12	7.5	12	7.5	12	ns	
		CL=3.0	5	10	-	-	-	-	-	-		
Clock high level width	tCH	0.45	0.55	0.45	0.55	0.45	0.55	0.45	0.55	tCK		
Clock low level width	tCL	0.45	0.55	0.45	0.55	0.45	0.55	0.45	0.55	tCK		
DQS-out access time from CK/CK	tDQSQ	-0.55	+0.55	-0.6	+0.6	-0.75	+0.75	-0.75	+0.75	ns		
Output data access time from CK/CK	tAC	-0.65	+0.65	-0.7	+0.7	-0.75	+0.75	-0.75	+0.75	ns		
Data strobe edge to output data edge	tDQSQ	-	0.4	-	0.45	-	0.5	-	0.5	ns	22	
Read Preamble	tRPRE	0.9	1.1	0.9	1.1	0.9	1.1	0.9	1.1	tCK		
Read Postamble	tRPST	0.4	0.6	0.4	0.6	0.4	0.6	0.4	0.6	tCK		
CK to valid DQS-in	tDQSS	0.72	1.28	0.75	1.25	0.75	1.25	0.75	1.25	tCK		
DQS-in setup time	tWPRES	0		0		0		0		ns	13	
DQS-in hold time	tWPRE	0.25		0.25		0.25		0.25		tCK		
DQS falling edge to CK rising-setup time	tDSS	0.2		0.2		0.2		0.2		tCK		
DQS falling edge from CK rising-hold time	tDSH	0.2		0.2		0.2		0.2		tCK		
DQS-in high level width	tDQSH	0.35		0.35		0.35		0.35		tCK		
DQS-in low level width	tDQSL	0.35		0.35		0.35		0.35		tCK		
Address and Control Input setup time(fast)	tIS	0.6		0.75		0.9		0.9		ns	15, 17~19	
Address and Control Input hold time(fast)	tIH	0.6		0.75		0.9		0.9		ns	15, 17~19	
Address and Control Input setup	tIS	0.7		0.8		1.0		1.0		ns	16~19	
Address and Control Input hold time(slow)	tIH	0.7		0.8		1.0		1.0		ns	16~19	
Data-out high impedance time from CK/CK	tHZ	-0.65	+0.65	-0.7	+0.7	-0.75	+0.75	-0.75	+0.75	ns	11	
Data-out low impedance time from CK/CK	tLZ	-0.65	+0.65	-0.7	+0.7	-0.75	+0.75	-0.75	+0.75	ns	11	
Mode register set cycle time	tMRD	10		12		15		15		ns		
DQ & DM setup time to DQS	tDS	0.4		0.45		0.5		0.5		ns	j, k	
DQ & DM hold time to DQS	tDH	0.4		0.45		0.5		0.5		ns	j, k	
Control & Address input pulse width	tIPW	2.2		2.2		2.2		2.2		ns	18	
DQ & DM input pulse width	tDIPW	1.75		1.75		1.75		1.75		ns	18	
Exit self refresh to non-Read command	tXSNR	75		75		75		75		ns		
Exit self refresh to read command	tXSRD	200		200		200		200		tCK		
Refresh interval time	tREFI		7.8		7.8		7.8		7.8	us	14	
Output DQS valid window	tQH	tHP -tQHS	-	tHP -tQHS	-	tHP -tQHS	-	tHP -tQHS	-	ns	21	
Clock half period	tHP	tCLmin or tCHmin	-	tCLmin or tCHmin	-	tCLmin or tCHmin	-	tCLmin or tCHmin	-	ns	20, 21	
Data hold skew factor	tQHS		0.5		0.55		0.75		0.75	ns	21	
DQS write postamble time	tWPST	0.4	0.6	0.4	0.6	0.4	0.6	0.4	0.6	tCK	12	
Active to Read with Auto precharge command	tRAP	15		18		20		20				
Autoprecharge write recovery + Precharge time	tDAL	(tWR/tCK) + (tRP/tCK)		(tWR/tCK) + (tRP/tCK)		(tWR/tCK) + (tRP/tCK)		(tWR/tCK) + (tRP/tCK)		tCK	23	



# DDR SDRAM 512Mb D-die (x8)

## 20.0 System Characteristics for DDR SDRAM

The following specification parameters are required in systems using DDR333, DDR266 & DDR200 devices to ensure proper system performance. these characteristics are for system simulation purposes and are guaranteed by design.

**Table 1 : Input Slew Rate for DQ, DQS, and DM**

AC CHARACTERISTICS		DDR333		DDR266		DDR200		Units	Notes
PARAMETER	SYMBOL	MIN	MAX	MIN	MAX	MIN	MAX		
DQ/DM/DQS input slew rate measured between VIH(DC), VIL(DC) and VIL(DC), VIH(DC)	DCSLEW	TBD	TBD	TBD	TBD	0.5	4.0	V/ns	a, l

**Table 2 : Input Setup & Hold Time Derating for Slew Rate**

Input Slew Rate	$\Delta t_{IS}$	$\Delta t_{IH}$	Units	Notes
0.5 V/ns	0	0	ps	i
0.4 V/ns	+50	0	ps	i
0.3 V/ns	+100	0	ps	i

**Table 3 : Input/Output Setup & Hold Time Derating for Slew Rate**

Input Slew Rate	$\Delta t_{DS}$	$\Delta t_{DH}$	Units	Notes
0.5 V/ns	0	0	ps	k
0.4 V/ns	+75	+75	ps	k
0.3 V/ns	+150	+150	ps	k

**Table 4 : Input/Output Setup & Hold Derating for Rise/Fall Delta Slew Rate**

Delta Slew Rate	$\Delta t_{DS}$	$\Delta t_{DH}$	Units	Notes
+/- 0.0 V/ns	0	0	ps	j
+/- 0.25 V/ns	+50	+50	ps	j
+/- 0.5 V/ns	+100	+100	ps	j

**Table 5 : Output Slew Rate Characteristic (X4, X8 Devices only)**

Slew Rate Characteristic	Typical Range (V/ns)	Minimum (V/ns)	Maximum (V/ns)	Notes
Pullup Slew Rate	1.2 ~ 2.5	1.0	4.5	a,c,d,f,g,h
Pulldown slew	1.2 ~ 2.5	1.0	4.5	b,c,d,f,g,h

**Table 6 : Output Slew Rate Characteristic (X16 Devices only)**

Slew Rate Characteristic	Typical Range (V/ns)	Minimum (V/ns)	Maximum (V/ns)	Notes
Pullup Slew Rate	1.2 ~ 2.5	0.7	5.0	a,c,d,f,g,h
Pulldown slew	1.2 ~ 2.5	0.7	5.0	b,c,d,f,g,h

**Table 7 : Output Slew Rate Matching Ratio Characteristics**

AC CHARACTERISTICS		DDR266B		DDR200		Notes
PARAMETER		MIN	MAX	MIN	MAX	
Output Slew Rate Matching Ratio (Pullup to Pulldown)		TBD	TBD	0.67	1.5	e, l

## 21.0 Component Notes

1. All voltages referenced to Vss.
2. Tests for ac timing, IDD, and electrical, ac and dc characteristics, may be conducted at nominal reference/supply voltage levels, but the related specifications and device operation are guaranteed for the full voltage range specified.
3. Figure 1 represents the timing reference load used in defining the relevant timing parameters of the part. It is not intended to be either a precise representation of the typical system environment nor a depiction of the actual load presented by a production tester. System designers will use IBIS or other simulation tools to correlate the timing reference load to a system environment. Manufacturers will correlate to their production test conditions (generally a coaxial transmission line terminated at the tester electronics).

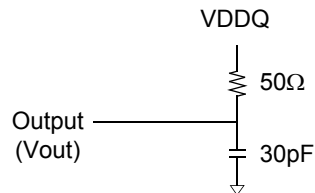

Figure 1 : Timing Reference Load

4. AC timing and IDD tests may use a VIL to VIH swing of up to 1.5 V in the test environment, but input timing is still referenced to VREF (or to the crossing point for CK/CK), and parameter specifications are guaranteed for the specified ac input levels under normal use conditions. The minimum slew rate for the input signals is 1 V/ns in the range between VIL(ac) and VIH(ac).
5. The ac and dc input level specifications are as defined in the SSTL\_2 Standard (i.e., the receiver will effectively switch as a result of the signal crossing the ac input level and will remain in that state as long as the signal does not ring back above (below) the dc input LOW (HIGH) level.
6. Inputs are not recognized as valid until VREF stabilizes. Exception: during the period before VREF stabilizes,  $CKE \leq 0.2VDDQ$  is recognized as LOW.
7. Enables on.chip refresh and address counters.
8. IDD specifications are tested after the device is properly initialized.
9. The  $\overline{CK}/\overline{CK}$  input reference level (for timing referenced to  $\overline{CK}/\overline{CK}$ ) is the point at which CK and  $\overline{CK}$  cross; the input reference level for signals other than  $\overline{CK}/\overline{CK}$ , is VREF.
10. The output timing reference voltage level is VTT.
11. tHZ and tLZ transitions occur in the same access time windows as valid data transitions. These parameters are not referenced to a specific voltage level but specify when the device output is no longer driving (HZ), or begins driving (LZ).
12. The maximum limit for this parameter is not a device limit. The device will operate with a greater value for this parameter, but system performance (bus turnaround) will degrade accordingly.
13. The specific requirement is that DQS be valid (HIGH, LOW, or at some point on a valid transition) on or before this CK edge. A valid transition is defined as monotonic and meeting the input slew rate specifications of the device. when no writes were previously in progress on the bus, DQS will be transitioning from High-Z to logic LOW. If a previous write was in progress, DQS could be HIGH, LOW, or transitioning from HIGH to LOW at this time, depending on tDQSS.
14. A maximum of eight AUTO REFRESH commands can be posted to any given DDR SDRAM device.
15. For command/address input slew rate  $\geq 1.0$  V/ns
16. For command/address input slew rate  $\geq 0.5$  V/ns and  $< 1.0$  V/ns

## Component Notes

17. For CK &  $\overline{CK}$  slew rate  $\geq 1.0$  V/ns
18. These parameters guarantee device timing, but they are not necessarily tested on each device. They may be guaranteed by device design or tester correlation.
19. Slew Rate is measured between VOH(ac) and VOL(ac).
20. Min (tCL, tCH) refers to the smaller of the actual clock low time and the actual clock high time as provided to the device (i.e. this value can be greater than the minimum specification limits for tCL and tCH)....For example, tCL and tCH are = 50% of the period, less the half period jitter (tJIT(HP)) of the clock source, and less the half period jitter due to crosstalk (tJIT(crosstalk)) into the clock traces.
21. tQH = tHP - tQHS, where:  
tHP = minimum half clock period for any given cycle and is defined by clock high or clock low (tCH, tCL). tQHS accounts for 1) The pulse duration distortion of on-chip clock circuits; and 2) The worst case push-out of DQS on one transition followed by the worst case pull-in of DQ on the next transition, both of which are, separately, due to data pin skew and output pattern effects, and p-channel to n-channel variation of the output drivers.
22. tDQSQ  
Consists of data pin skew and output pattern effects, and p-channel to n-channel variation of the output drivers for any given cycle.
23. tDAL = (tWR/tCK) + (tRP/tCK)  
For each of the terms above, if not already an integer, round to the next highest integer. Example: For DDR266B at CL=2.5 and tCK=7.5ns tDAL = (15 ns / 7.5 ns) + (20 ns / 7.5ns) = (2) + (3)  
tDAL = 5 clocks

## 22.0 System Notes

a. Pullup slew rate is characterized under the test conditions as shown in Figure 2.

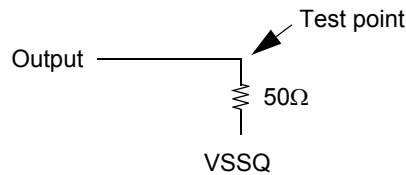

Figure 2 : Pullup slew rate test load

b. Pulldown slew rate is measured under the test conditions shown in Figure 3.

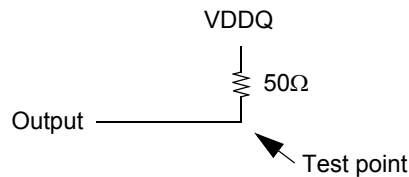

Figure 3 : Pulldown slew rate test load

c. Pullup slew rate is measured between  $(VDDQ/2 - 320 \text{ mV} \pm 250 \text{ mV})$   
 Pulldown slew rate is measured between  $(VDDQ/2 + 320 \text{ mV} \pm 250 \text{ mV})$   
 Pullup and Pulldown slew rate conditions are to be met for any pattern of data, including all outputs switching and only one output switching.

Example : For typical slew rate, DQ0 is switching

For minimum slew rate, all DQ bits are switching from either high to low, or low to high.

The remaining DQ bits remain the same as for previous state.

d. Evaluation conditions

Typical : 25 °C (T Ambient), VDDQ = 2.5V(for DDR266/333) and 2.6V(for DDR400), typical process

Minimum : 70 °C (T Ambient), VDDQ = 2.3V(for DDR266/333) and 2.5V(for DDR400), slow - slow process

Maximum : 0 °C (T Ambient), VDDQ = 2.7V(for DDR266/333) and 2.7V(for DDR400), fast - fast process

e. The ratio of pullup slew rate to pulldown slew rate is specified for the same temperature and voltage, over the entire temperature and voltage range. For a given output, it represents the maximum difference between pullup and pulldown drivers due to process variation.

f. Verified under typical conditions for qualification purposes.

g. TSOP11 package devices only.

h. Only intended for operation up to 266 Mbps per pin.

i. A derating factor will be used to increase  $t_{IS}$  and  $t_{IH}$  in the case where the input slew rate is below 0.5V/ns as shown in Table 2. The Input slew rate is based on the lesser of the slew rates determined by either  $V_{IH}(AC)$  to  $V_{IL}(AC)$  or  $V_{IH}(DC)$  to  $V_{IL}(DC)$ , similarly for rising transitions.

j. A derating factor will be used to increase  $t_{DS}$  and  $t_{DH}$  in the case where DQ, DM, and DQS slew rates differ, as shown in Tables 3 & 4. Input slew rate is based on the larger of AC-AC delta rise, fall rate and DC-DC delta rise, Input slew rate is based on the lesser of the slew rates determined by either  $V_{IH}(AC)$  to  $V_{IL}(AC)$  or  $V_{IH}(DC)$  to  $V_{IL}(DC)$ , similarly for rising transitions.

The delta rise/fall rate is calculated as:

$$\{1/(\text{Slew Rate1})\} - \{1/(\text{Slew Rate2})\}$$

For example : If Slew Rate 1 is 0.5 V/ns and slew Rate 2 is 0.4 V/ns, then the delta rise, fall rate is - 0.5ns/V . Using the table given, this would result in the need for an increase in  $t_{DS}$  and  $t_{DH}$  of 100 ps.

k. Table 3 is used to increase  $t_{DS}$  and  $t_{DH}$  in the case where the I/O slew rate is below 0.5 V/ns. The I/O slew rate is based on the lesser of the AC - AC slew rate and the DC- DC slew rate. The input slew rate is based on the lesser of the slew rates determined by either  $V_{IH}(ac)$  to  $V_{IL}(ac)$  or  $V_{IH}(DC)$  to  $V_{IL}(DC)$ , and similarly for rising transitions.

l. DQS, DM, and DQ input slew rate is specified to prevent double clocking of data and preserve setup and hold times. Signal transitions through the DC region must be monotonic.

### 23.0 IBIS : I/V Characteristics for Input and Output Buffers

#### DDR SDRAM Output Driver V-I Characteristics

DDR SDRAM Output driver characteristics are defined for full and half strength operation as selected by the EMRS bit A1.

Figures 3 and 4 show the driver characteristics graphically, and tables 8 and 9 show the same data in tabular format suitable for input into simulation tools. The driver characteristics evaluation conditions are:

Typical	25×C	V <sub>dd</sub> /V <sub>ddq</sub> = 2.5V, typical process
Minimum	70×C	V <sub>dd</sub> /V <sub>ddq</sub> = 2.3V, slow-slow process
Maximum	0×C	V <sub>dd</sub> /V <sub>ddq</sub> = 2.7V, fast-fast process

#### Output Driver Characteristic Curves Notes:

1. The full variation in driver current from minimum to maximum process, temperature and voltage will lie within the outer bounding lines the of the V-I curve of Figure 3 and 4.
2. It is recommended that the "typical" IBIS V-I curve lie within the inner bounding lines of the V-I curves of Figure 3 and 4.
3. The full variation in the ratio of the "typical" IBIS pullup to "typical" IBIS pulldown current should be unity +/- 10%, for device drain to source voltages from 0.1 to 1.0. This specification is a design objective only. It is not guaranteed.

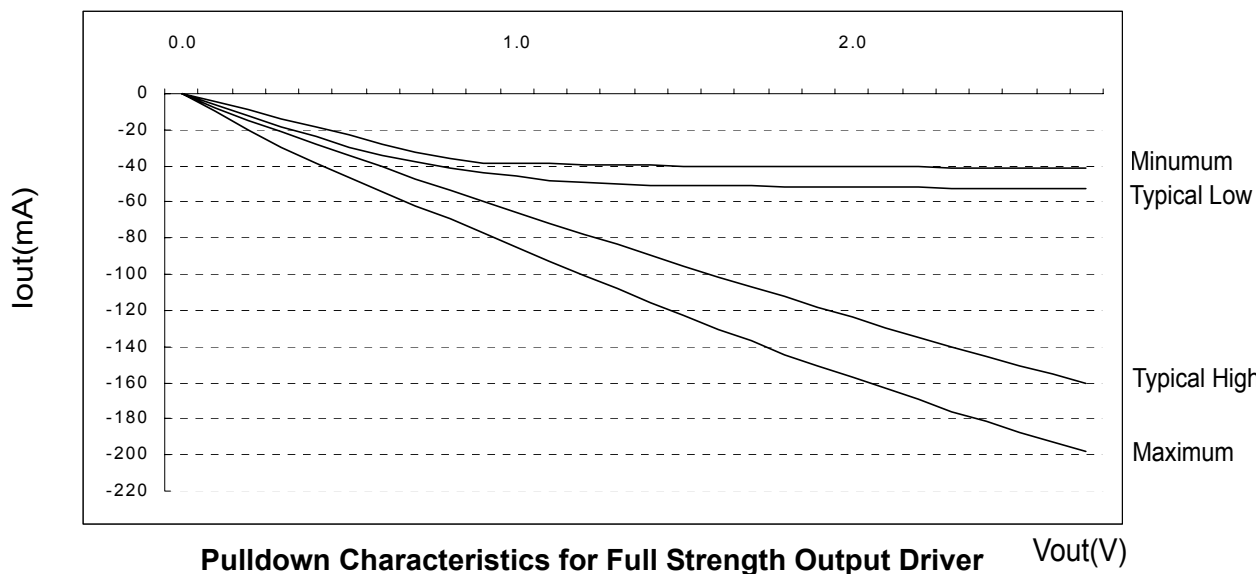
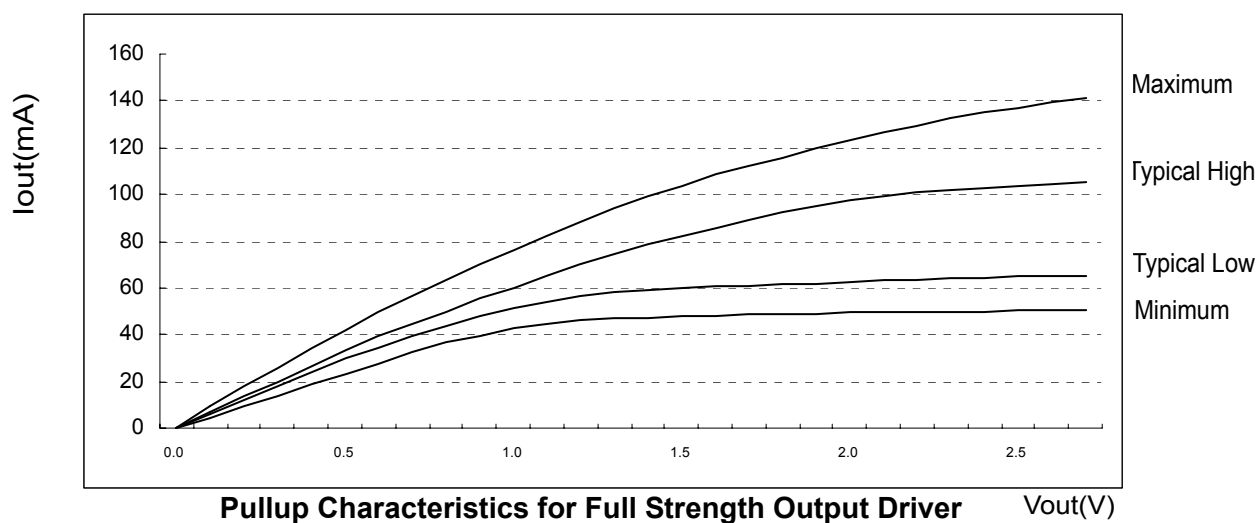

**Figure 3. I/V characteristics for input/output buffers: Pull up(above) and pull down(below)**

Voltage (V)	Pulldown Current (mA)				pullup Current (mA)			
	Typical Low	Typical High	Minimum	Maximum	Typical Low	Typical High	Minimum	Maximum
0.1	6.0	6.8	4.6	9.6	-6.1	-7.6	-4.6	-10.0
0.2	12.2	13.5	9.2	18.2	-12.2	-14.5	-9.2	-20.0
0.3	18.1	20.1	13.8	26.0	-18.1	-21.2	-13.8	-29.8
0.4	24.1	26.6	18.4	33.9	-24.0	-27.7	-18.4	-38.8
0.5	29.8	33.0	23.0	41.8	-29.8	-34.1	-23.0	-46.8
0.6	34.6	39.1	27.7	49.4	-34.3	-40.5	-27.7	-54.4
0.7	39.4	44.2	32.2	56.8	-38.1	-46.9	-32.2	-61.8
0.8	43.7	49.8	36.8	63.2	-41.1	-53.1	-36.0	-69.5
0.9	47.5	55.2	39.6	69.9	-41.8	-59.4	-38.2	-77.3
1.0	51.3	60.3	42.6	76.3	-46.0	-65.5	-38.7	-85.2
1.1	54.1	65.2	44.8	82.5	-47.8	-71.6	-39.0	-93.0
1.2	56.2	69.9	46.2	88.3	-49.2	-77.6	-39.2	-100.6
1.3	57.9	74.2	47.1	93.8	-50.0	-83.6	-39.4	-108.1
1.4	59.3	78.4	47.4	99.1	-50.5	-89.7	-39.6	-115.5
1.5	60.1	82.3	47.7	103.8	-50.7	-95.5	-39.9	-123.0
1.6	60.5	85.9	48.0	108.4	-51.0	-101.3	-40.1	-130.4
1.7	61.0	89.1	48.4	112.1	-51.1	-107.1	-40.2	-136.7
1.8	61.5	92.2	48.9	115.9	-51.3	-112.4	-40.3	-144.2
1.9	62.0	95.3	49.1	119.6	-51.5	-118.7	-40.4	-150.5
2.0	62.5	97.2	49.4	123.3	-51.6	-124.0	-40.5	-156.9
2.1	62.9	99.1	49.6	126.5	-51.8	-129.3	-40.6	-163.2
2.2	63.3	100.9	49.8	129.5	-52.0	-134.6	-40.7	-169.6
2.3	63.8	101.9	49.9	132.4	-52.2	-139.9	-40.8	-176.0
2.4	64.1	102.8	50.0	135.0	-52.3	-145.2	-40.9	-181.3
2.5	64.6	103.8	50.2	137.3	-52.5	-150.5	-41.0	-187.6
2.6	64.8	104.6	50.4	139.2	-52.7	-155.3	-41.1	-192.9
2.7	65.0	105.4	50.5	140.8	-52.8	-160.1	-41.2	-198.2

**Table 8. Full Strength Driver Characteristics**

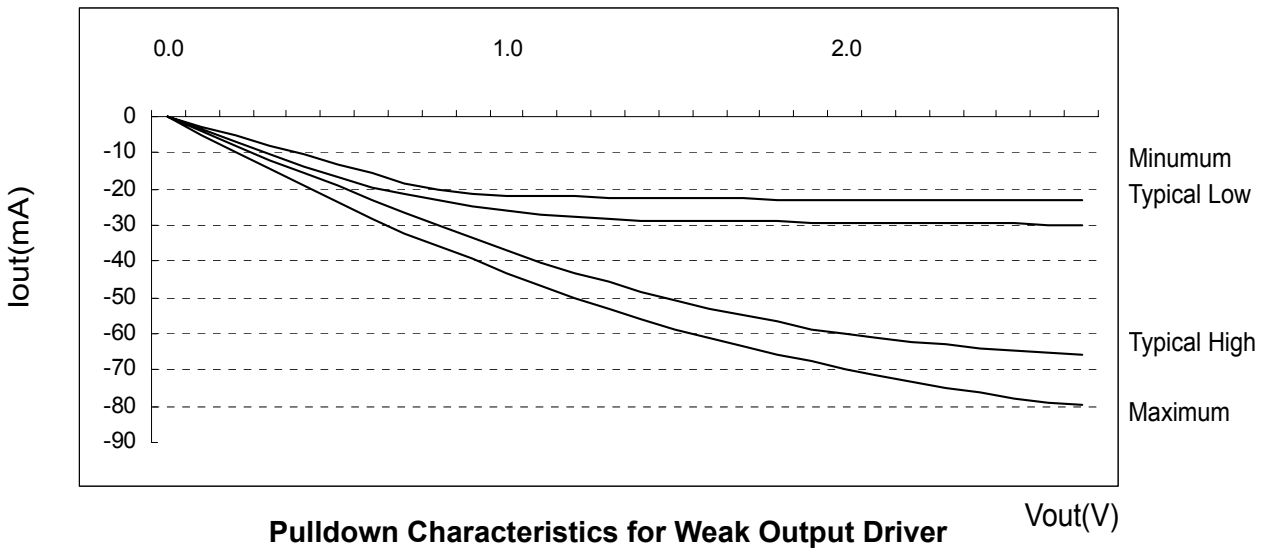
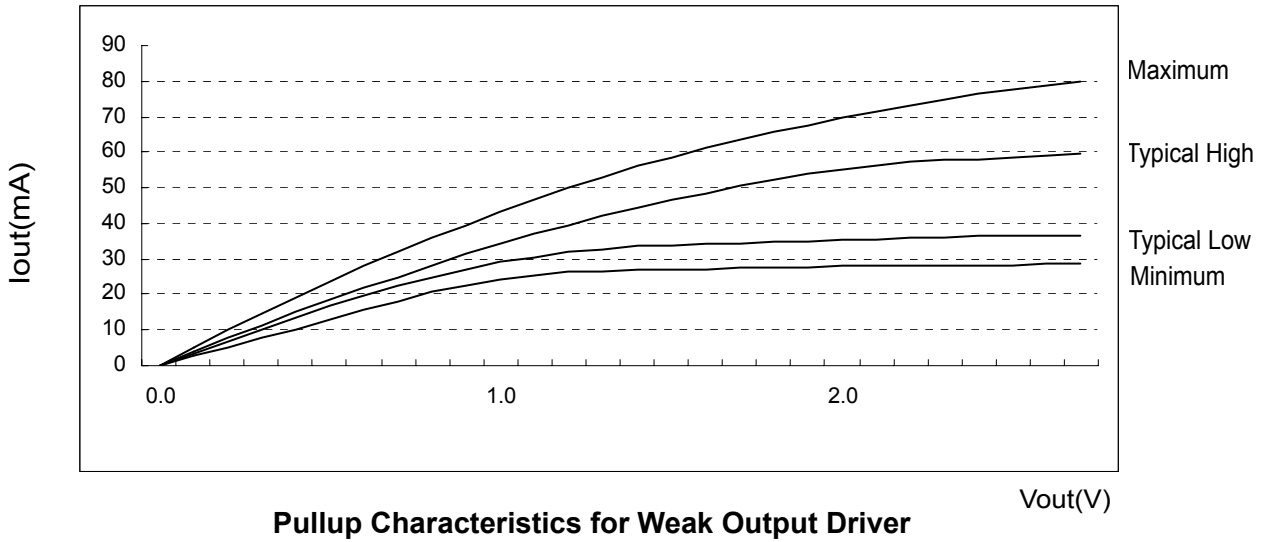

Figure 4. I/V characteristics for input/output buffers: Pull up (above) and pull down (below)

Voltage (V)	Pulldown Current (mA)				pullup Current (mA)			
	Typical Low	Typical High	Minimum	Maximum	Typical Low	Typical High	Minimum	Maximum
0.1	3.4	3.8	2.6	5.0	-3.5	-4.3	-2.6	-5.0
0.2	6.9	7.6	5.2	9.9	-6.9	-8.2	-5.2	-9.9
0.3	10.3	11.4	7.8	14.6	-10.3	-12.0	-7.8	-14.6
0.4	13.6	15.1	10.4	19.2	-13.6	-15.7	-10.4	-19.2
0.5	16.9	18.7	13.0	23.6	-16.9	-19.3	-13.0	-23.6
0.6	19.6	22.1	15.7	28.0	-19.4	-22.9	-15.7	-28.0
0.7	22.3	25.0	18.2	32.2	-21.5	-26.5	-18.2	-32.2
0.8	24.7	28.2	20.8	35.8	-23.3	-30.1	-20.4	-35.8
0.9	26.9	31.3	22.4	39.5	-24.8	-33.6	-21.6	-39.5
1.0	29.0	34.1	24.1	43.2	-26.0	-37.1	-21.9	-43.2
1.1	30.6	36.9	25.4	46.7	-27.1	-40.3	-22.1	-46.7
1.2	31.8	39.5	26.2	50.0	-27.8	-43.1	-22.2	-50.0
1.3	32.8	42.0	26.6	53.1	-28.3	-45.8	-22.3	-53.1
1.4	33.5	44.4	26.8	56.1	-28.6	-48.4	-22.4	-56.1
1.5	34.0	46.6	27.0	58.7	-28.7	-50.7	-22.6	-58.7
1.6	34.3	48.6	27.2	61.4	-28.9	-52.9	-22.7	-61.4
1.7	34.5	50.5	27.4	63.5	-28.9	-55.0	-22.7	-63.5
1.8	34.8	52.2	27.7	65.6	-29.0	-56.8	-22.8	-65.6
1.9	35.1	53.9	27.8	67.7	-29.2	-58.7	-22.9	-67.7
2.0	35.4	55.0	28.0	69.8	-29.2	-60.0	-22.9	-69.8
2.1	35.6	56.1	28.1	71.6	-29.3	-61.2	-23.0	-71.6
2.2	35.8	57.1	28.2	73.3	-29.5	-62.4	-23.0	-73.3
2.3	36.1	57.7	28.3	74.9	-29.5	-63.1	-23.1	-74.9
2.4	36.3	58.2	28.3	76.4	-29.6	-63.8	-23.2	-76.4
2.5	36.5	58.7	28.4	77.7	-29.7	-64.4	-23.2	-77.7
2.6	36.7	59.2	28.5	78.8	-29.8	-65.1	-23.3	-78.8
2.7	36.8	59.6	28.6	79.7	-29.9	-65.8	-23.3	-79.7

**Table 9. Weak Driver Characteristics**