

SMD Power Inductor

CDRH124



Description

- Ferrite drum core construction
- Magnetically shielded
- LxWxH: 12.3x12.3x4.5 mm Max.
- Product weight: 2.3g(Ref.)
- Moisture Sensitivity Level: 1
- RoHS compliance

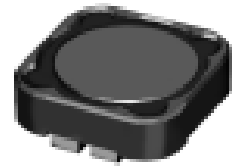

Environmental Data

- Operating temperature range: -40°C ~ +100°C (including coil's self-temperature rise)
- Storage temperature range: -40°C ~ +100°C
- Solder reflow temperature: 260 °C peak

Packaging

- Carrier tape and reel packaging.
- 13" diameter reel
- 500pcs per reel

Applications

- Ideally used in notebook PC, LCD TV, DVD, game machine, STB, projector, etc. as DC-DC converter inductor

Dimension - [mm]

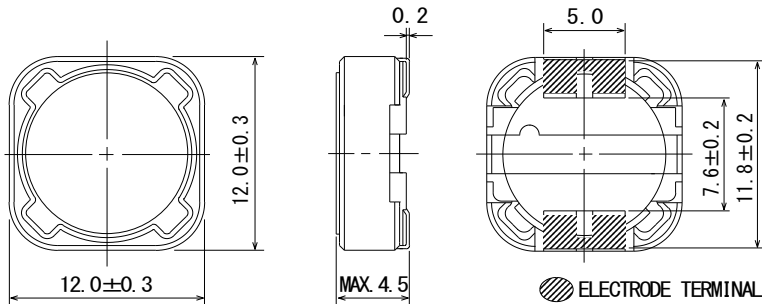

Recommended Land pattern - [mm]

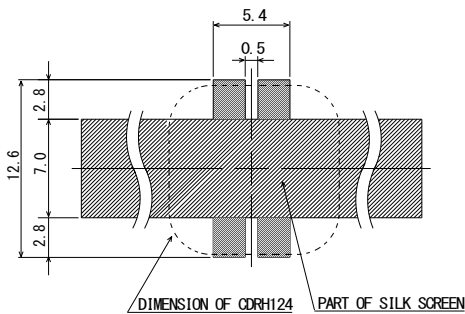

Wire Connection

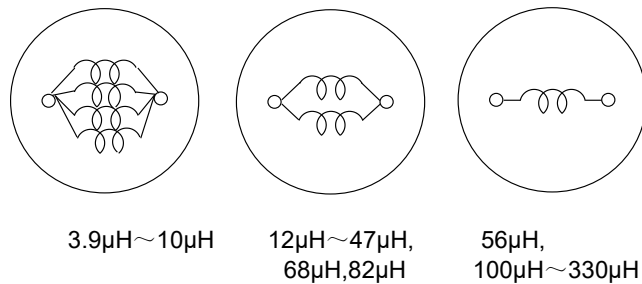

No vias and traces in the restricted area underneath the coil

SMD Power Inductor

CDRH124



Electrical Characteristics

Part Number	Stamp	Inductance [Within] ※1	D.C.R. (mΩ) (at 20°C) Max. (Typ.)	Saturation Current (A) ※2 Max. (Typ.)	Temperature Rise Current (A) ※3
CDRH124NP-3R9MC	3R9	3.9μH ± 20%	15(12)	8.60(10.80)	7.30
CDRH124NP-4R7MC	4R7	4.7μH ± 20%	18(14)	7.75(9.70)	6.60
CDRH124NP-6R8MC	6R8	6.8μH ± 20%	23(18)	6.40(8.00)	5.90
CDRH124NP-8R2MC	8R2	8.2μH ± 20%	26(21)	6.32(7.90)	5.40
CDRH124NP-100MC	100	10 μH ± 20%	28(22)	5.60(7.00)	5.05
CDRH124NP-120MC	120	12 μH ± 20%	38(30)	4.96(6.20)	4.55
CDRH124NP-150MC	150	15 μH ± 20%	50(40)	4.32(5.40)	3.80
CDRH124NP-180MC	180	18 μH ± 20%	57(46)	3.96(4.95)	3.72
CDRH124NP-220MC	220	22 μH ± 20%	66(53)	3.80(4.75)	3.52
CDRH124NP-270MC	270	27 μH ± 20%	80(64)	3.08(3.85)	3.30
CDRH124NP-330MC	330	33 μH ± 20%	97(78)	2.96(3.70)	3.10
CDRH124NP-390MC	390	39 μH ± 20%	132(106)	2.66(3.32)	2.55
CDRH124NP-470MC	470	47 μH ± 20%	150(120)	2.56(3.20)	2.28
CDRH124NP-560MC	560	56 μH ± 20%	190(152)	2.36(2.95)	2.10
CDRH124NP-680MC	680	68 μH ± 20%	220(176)	2.14(2.67)	1.80
CDRH124NP-820MC	820	82 μH ± 20%	260(208)	1.90(2.37)	1.55
CDRH124NP-101MC	101	100μH ± 20%	308(246)	1.66(2.07)	1.40
CDRH124NP-121MC	121	120μH ± 20%	380(304)	1.52(1.90)	1.32
CDRH124NP-151MC	151	150μH ± 20%	530(424)	1.42(1.77)	1.20
CDRH124NP-181MC	181	180μH ± 20%	620(496)	1.33(1.66)	1.06
CDRH124NP-221MC	221	220μH ± 20%	700(560)	1.18(1.48)	0.93
CDRH124NP-271MC	271	270μH ± 20%	870(696)	0.98(1.23)	0.76
CDRH124NP-331MC	331	330μH ± 20%	990(792)	0.90(1.13)	0.65

※1. Measured frequency at 100 kHz.

※2. Saturation current: This indicates the value of D.C. current when the inductance becomes 25% lower than its initial value. (Ta=20°C).

※3. Temperature rise current :The actual value of D.C. current when the temperature of coil becomes ΔT=40°C (Ta=20°C).

SMD Power Inductor

CDRH124



Saturation Current & Temperature Rise Graph

— L (20°C) — L (100°C) — ΔT

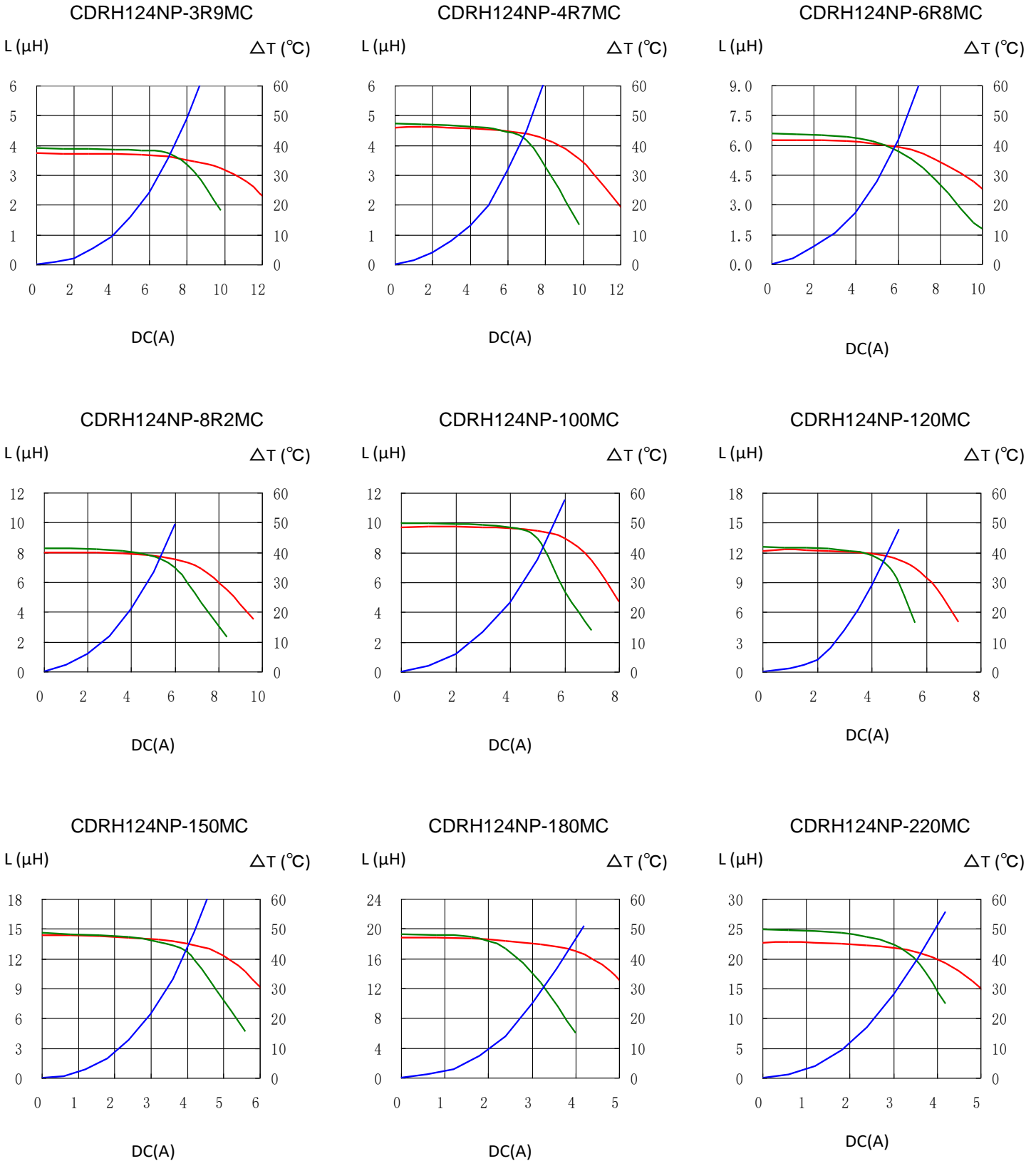

Note: This specification is subject to change without notice. Please contact your nearest sales office for updated information when placing an order.

SMD Power Inductor

CDRH124



CDRH124NP-270MC

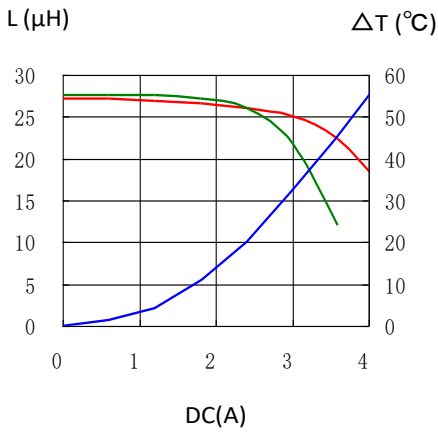

CDRH124NP-330MC

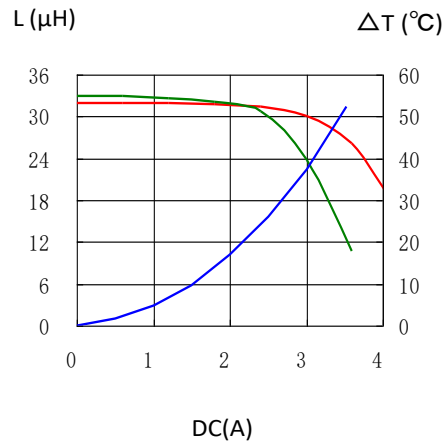

CDRH124NP-390MC

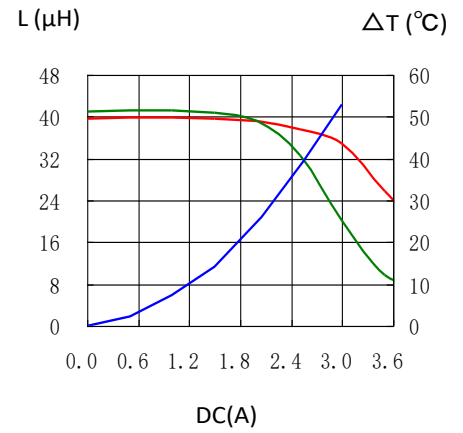

CDRH124NP-470MC

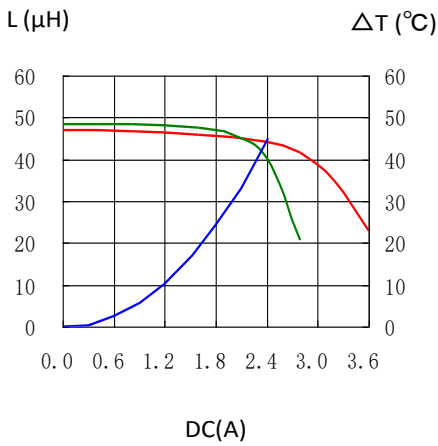

CDRH124NP-560MC

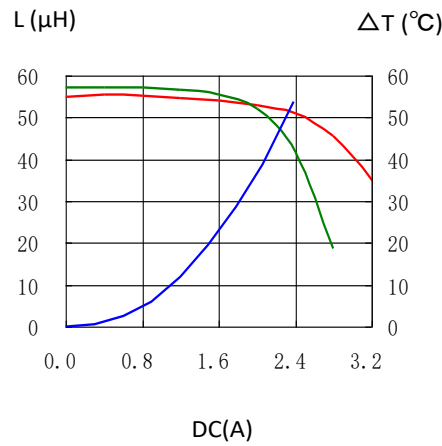

CDRH124NP-680MC

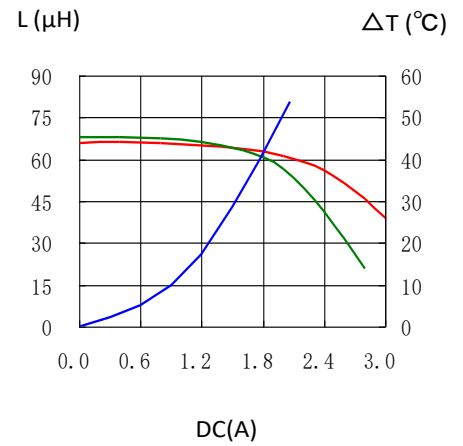

CDRH124NP-820MC

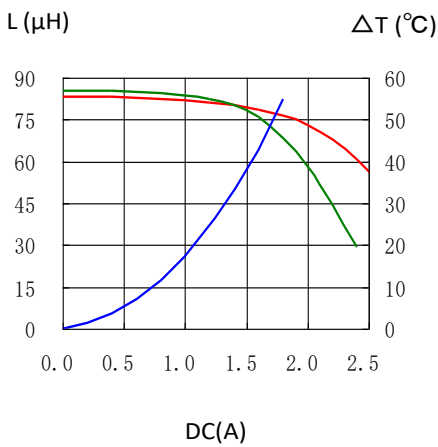

CDRH124NP-101MC

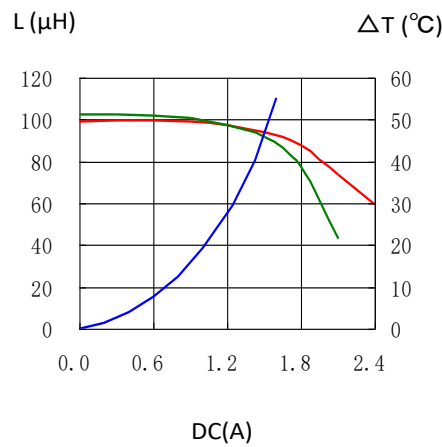

CDRH124NP-121MC

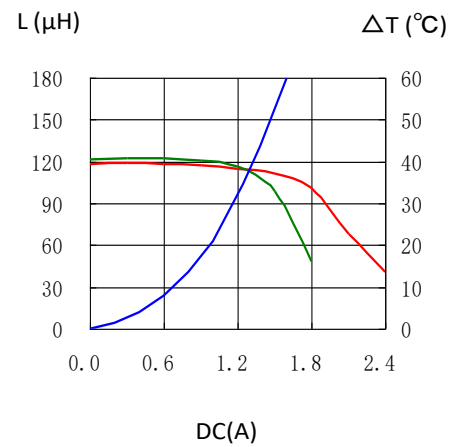

SMD Power Inductor

CDRH124



CDRH124NP-151MC

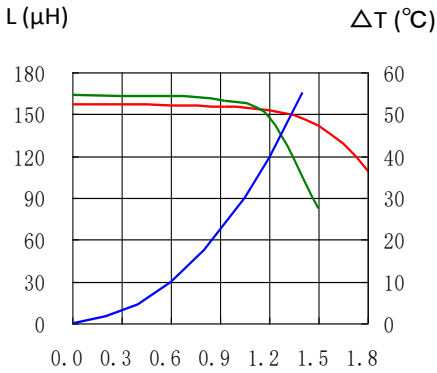

DC(A)

CDRH124NP-181MC

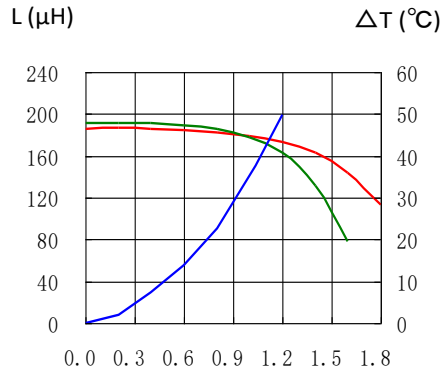

DC(A)

CDRH124NP-221MC

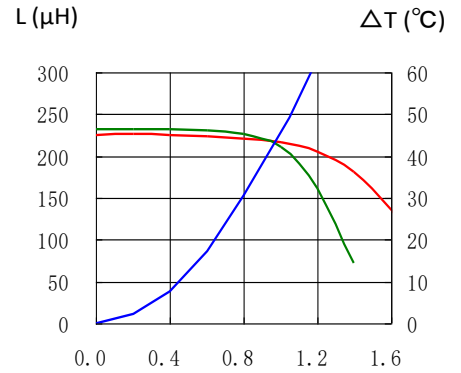

DC(A)

CDRH124NP-271MC

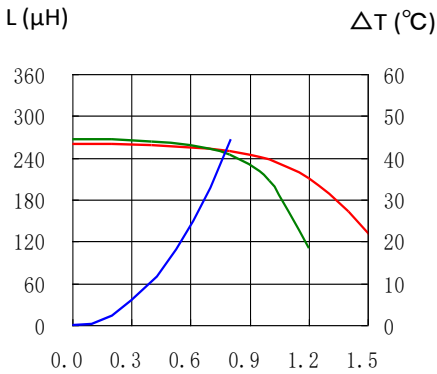

DC(A)

CDRH124NP-331MC

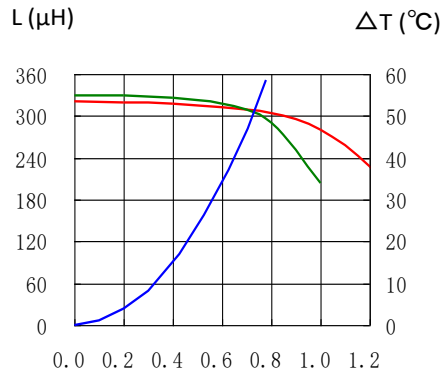

DC(A)

Solder Reflow Condition

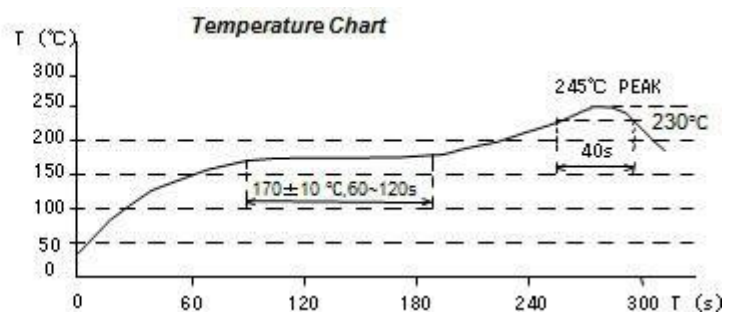
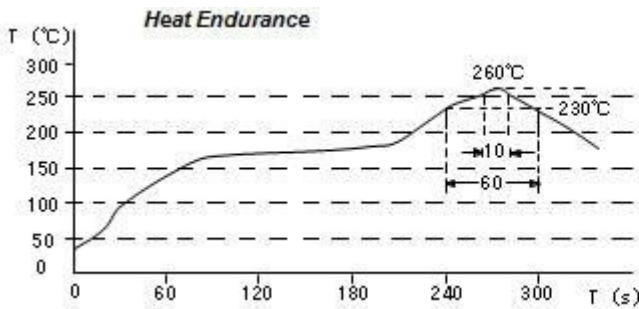

For sales office information, please [click here](#) to visit our website.

Note: This specification is subject to change without notice. Please contact your nearest sales office for updated information when placing an order.