

EMSL12J2H-195.3125M TR

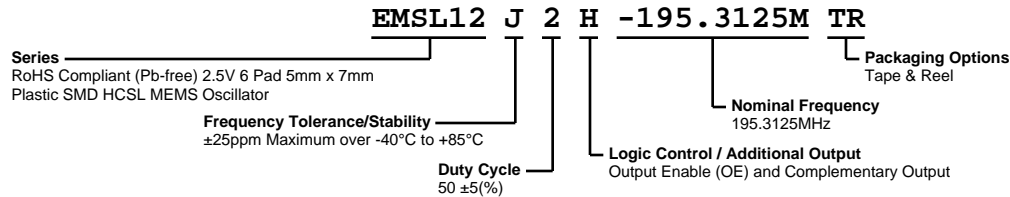

ECLIPTEK
CORPORATION



ELECTRICAL SPECIFICATIONS

Nominal Frequency	195.3125MHz
Frequency Tolerance/Stability	±25ppm Maximum over -40°C to +85°C (Inclusive of all conditions: Calibration Tolerance at 25°C, Frequency Stability over the Operating Temperature Range, Supply Voltage Change, Output Load Change, 1st Year Aging at 25°C, Reflow, Shock, and Vibration)
Aging at 25°C	±1ppm First Year Maximum
Supply Voltage	+2.5Vdc ±0.125Vdc
Input Current	65mA Maximum (Excluding Load Termination Current)
Output Voltage Logic High (Voh)	750mVdc Typical, 600mVdc Minimum
Output Voltage Logic Low (Vol)	25mVdc Typical, 50mVdc Maximum
Rise/Fall Time	300pSec Typical, 350pSec Maximum (Measured over 20% to 80% of waveform)
Duty Cycle	50 ±5(%) (Measured at 50% of waveform)
Load Drive Capability	50 Ohms to ground (Output and Complementary Output)
Output Logic Type	HCSSL
Logic Control / Additional Output	Output Enable (OE) and Complementary Output
Output Control Input Voltage	Vih of 70% of Vcc Minimum or No Connect to Enable Output and Complementary Output, Vil of 30% of Vcc Maximum to Disable Output and Complementary Output (High Impedance)
Output Enable Current	60mA Maximum (OE) Without Load
Period Jitter (Deterministic)	0.2pSec Typical
Period Jitter (Random)	2.0pSec Typical
Period Jitter (RMS)	1.5pSec Typical, 3.0pSec Maximum
Period Jitter (pk-pk)	20pSec Typical, 25pSec Maximum
Period Jitter (Cycle to Cycle)	10pSec Typical
RMS Phase Jitter (Fj = 637kHz to 10MHz; Random)	1.6pSec Typical
RMS Phase Jitter (Fj = 1.5MHz to 22MHz; Random)	0.4pSec Typical
RMS Phase Jitter (Fj = 1.875MHz to 20MHz; Random)	0.4pSec Typical
Start Up Time	10mSec Maximum
Storage Temperature Range	-55°C to +125°C

ENVIRONMENTAL & MECHANICAL SPECIFICATIONS

ESD Susceptibility	MIL-STD-883, Method 3015, Class 2, HBM 2000V
Flammability	UL94-V0
Mechanical Shock	MIL-STD-883, Method 2002, Condition G, 30,000G
Moisture Resistance	MIL-STD-883, Method 1004
Moisture Sensitivity Level	J-STD-020, MSL 1
Resistance to Soldering Heat	MIL-STD-202, Method 210, Condition K
Resistance to Solvents	MIL-STD-202, Method 215
Solderability	MIL-STD-883, Method 2003 (Six I/O Pads on bottom of package only)
Temperature Cycling	MIL-STD-883, Method 1010, Condition B
Thermal Shock	MIL-STD-883, Method 1011, Condition B
Vibration	MIL-STD-883, Method 2007, Condition A, 20G

EMSL12J2H-195.3125M TR

MECHANICAL DIMENSIONS (all dimensions in millimeters)

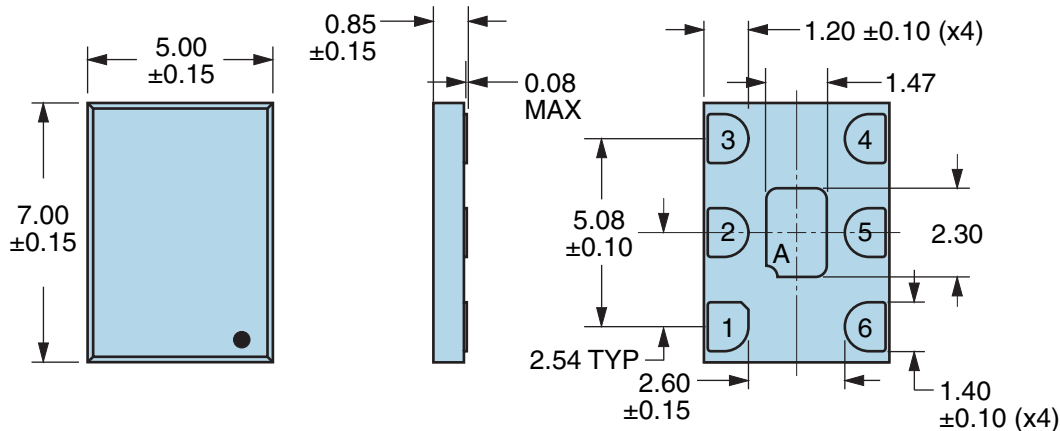

PIN	CONNECTION
1	Output Enable (OE)
2	No Connect
3	Case Ground
4	Output
5	Complementary Output
6	Supply Voltage

LINE	MARKING
1	XXXX or XXXXX XXXX or XXXXX=Ecliptek Manufacturing Lot Code

Note A: Center paddle is connected internally to oscillator ground (Pad 3).

Suggested Solder Pad Layout

All Dimensions in Millimeters

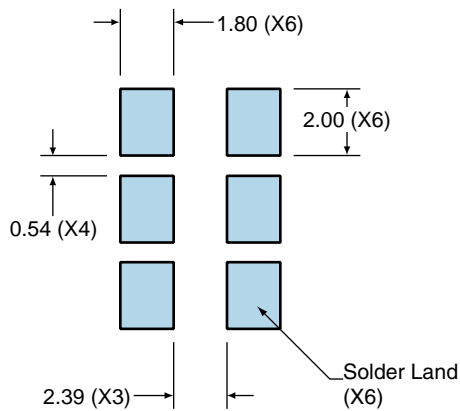

All Tolerances are ± 0.1

OUTPUT WAVEFORM & TIMING DIAGRAM

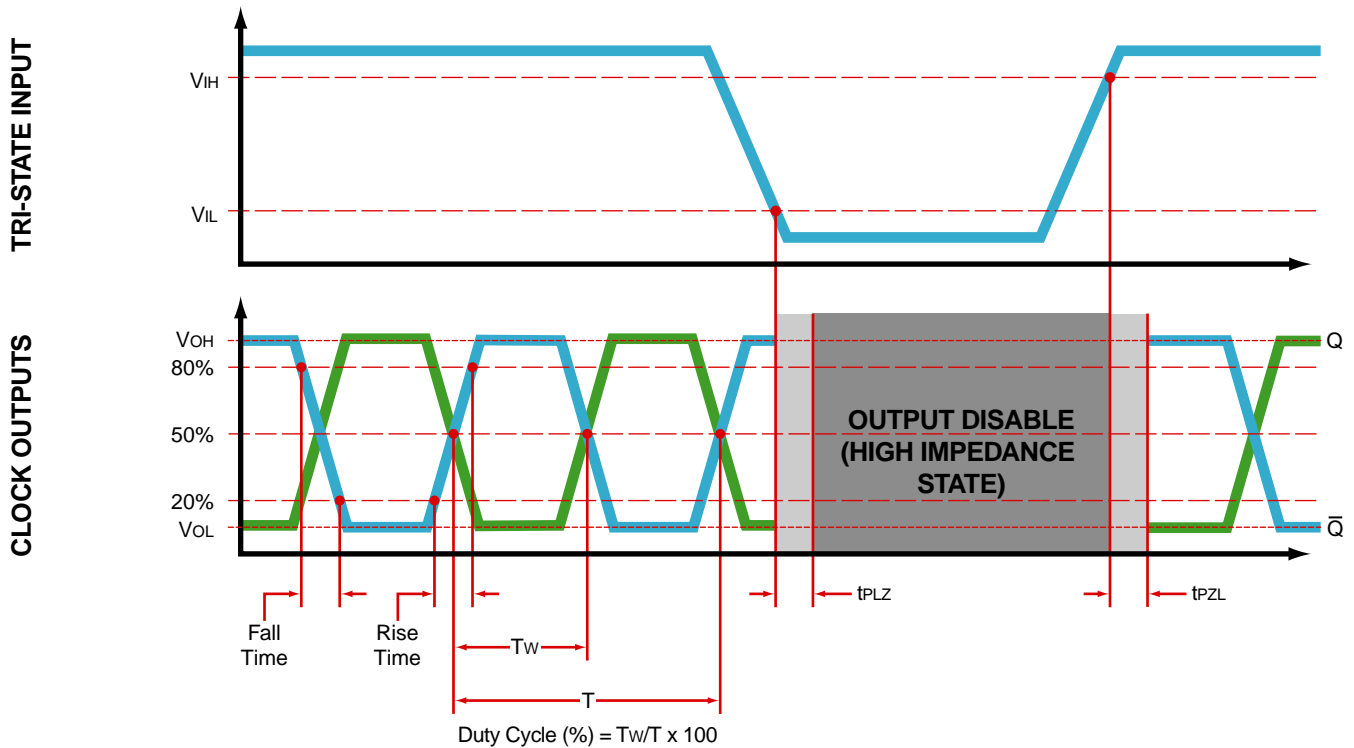

Test Circuit for Tri-State and Complementary Output

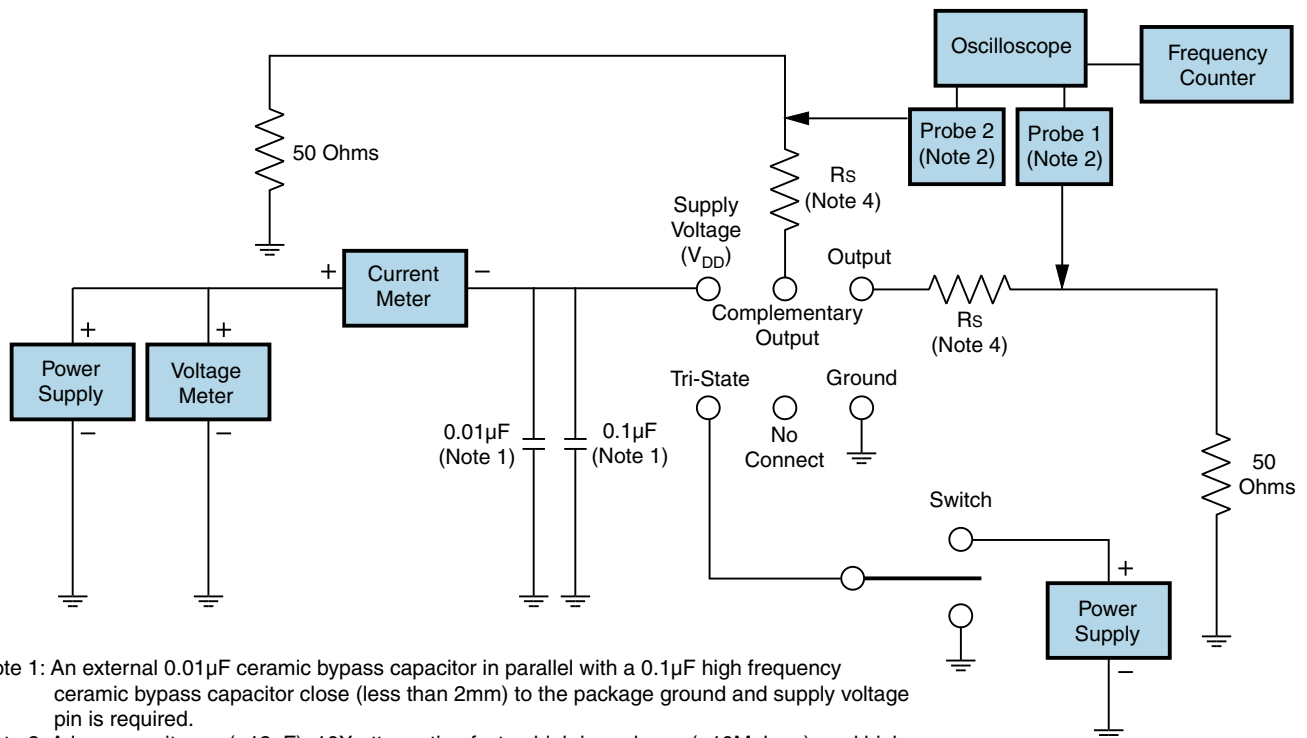

Note 1: An external 0.01µF ceramic bypass capacitor in parallel with a 0.1µF high frequency ceramic bypass capacitor close (less than 2mm) to the package ground and supply voltage pin is required.

Note 2: A low capacitance (<12pF), 10X attenuation factor, high impedance (>10Mohms), and high bandwidth (>500MHz) passive probe is recommended.

Note 3: Test circuit PCB traces need to be designed for a characteristic line impedance of 50 ohms.

Note 4: A 10 ohm to 33 ohm series resistor is required to limit overshoot. Rs value is circuit layout dependant.

EMSL12J2H-195.3125M TR

Tape & Reel Dimensions

Quantity Per Reel: 1,000 units

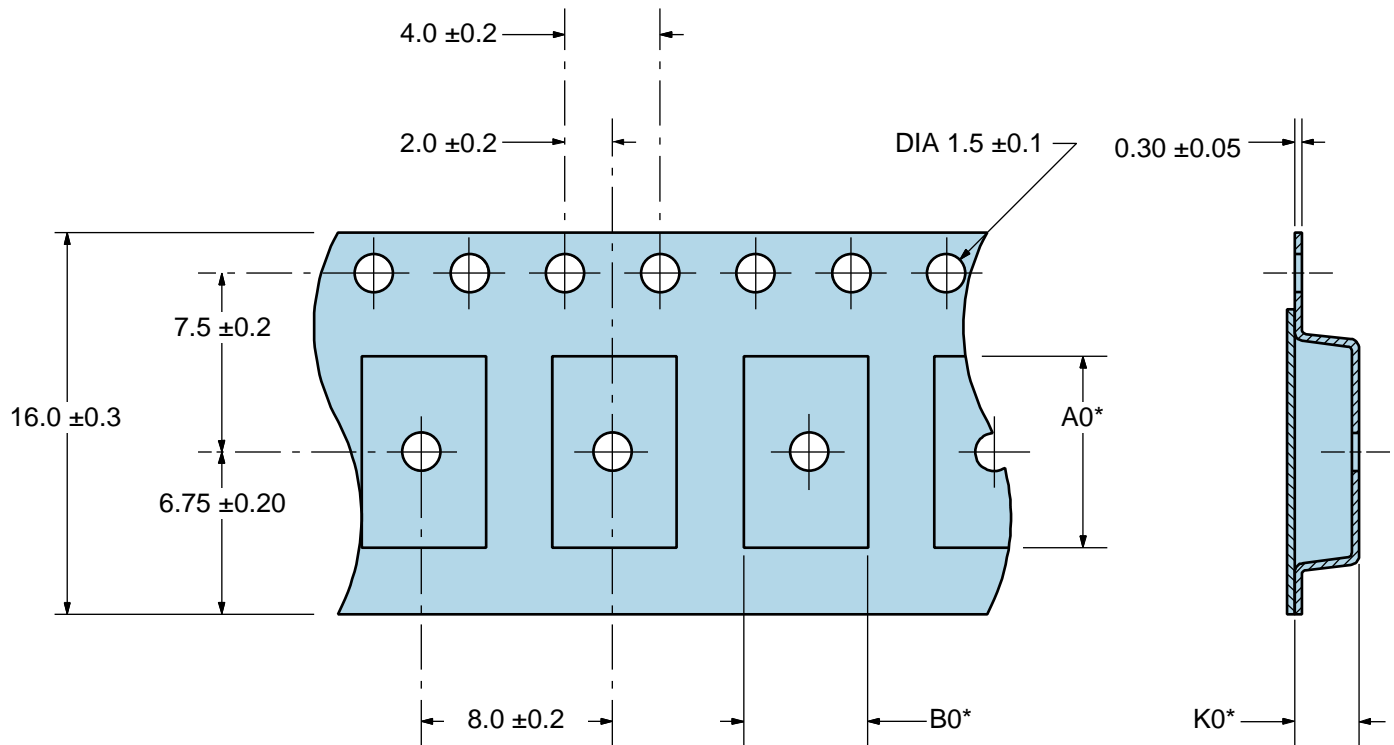

*Compliant to EIA 481A

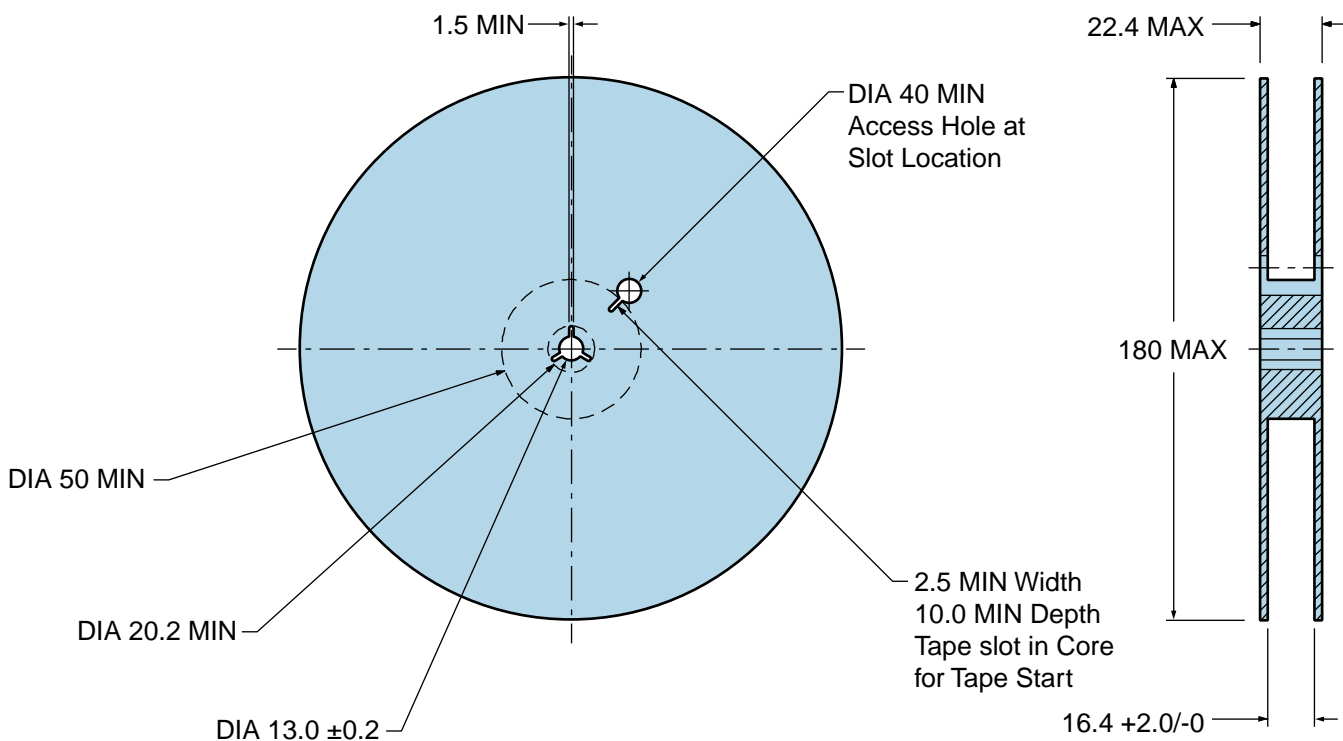

Recommended Solder Reflow Methods



High Temperature Infrared/Convection

T_S MAX to T_L (Ramp-up Rate)	3°C/second Maximum
Preheat	
- Temperature Minimum (T_S MIN)	150°C
- Temperature Typical (T_S TYP)	175°C
- Temperature Maximum (T_S MAX)	200°C
- Time (t_s MIN)	60 - 180 Seconds
Ramp-up Rate (T_L to T_P)	3°C/second Maximum
Time Maintained Above:	
- Temperature (T_L)	217°C
- Time (t_L)	60 - 150 Seconds
Peak Temperature (T_P)	260°C Maximum for 10 Seconds Maximum
Target Peak Temperature (T_P Target)	250°C +0/-5°C
Time within 5°C of actual peak (t_p)	20 - 40 seconds
Ramp-down Rate	6°C/second Maximum
Time 25°C to Peak Temperature (t)	8 minutes Maximum
Moisture Sensitivity Level	Level 1

Recommended Solder Reflow Methods



Low Temperature Infrared/Convection 240°C

T_s MAX to T_L (Ramp-up Rate)	5°C/second Maximum
Preheat	
- Temperature Minimum (T _s MIN)	N/A
- Temperature Typical (T _s TYP)	150°C
- Temperature Maximum (T _s MAX)	N/A
- Time (t _s MIN)	60 - 120 Seconds
Ramp-up Rate (T_L to T_p)	5°C/second Maximum
Time Maintained Above:	
- Temperature (T _L)	150°C
- Time (t _L)	200 Seconds Maximum
Peak Temperature (T_p)	240°C Maximum
Target Peak Temperature (T_p Target)	240°C Maximum 1 Time / 230°C Maximum 2 Times
Time within 5°C of actual peak (t_p)	10 seconds Maximum 2 Times / 80 seconds Maximum 1 Time
Ramp-down Rate	5°C/second Maximum
Time 25°C to Peak Temperature (t)	N/A
Moisture Sensitivity Level	Level 1

Low Temperature Manual Soldering

185°C Maximum for 10 seconds Maximum, 2 times Maximum.

High Temperature Manual Soldering

260°C Maximum for 5 seconds Maximum, 2 times Maximum.