



3.3V 1M x 18 SRAM with NTD™

Features

- Organization: 1,048,576 words × 18 bits
- NTD™¹ architecture for efficient bus operation
- Fast clock speeds to 200 MHz in LVTTTL/LVCMOS
- Fast clock to data access: 3/3.4/3.8 ns
- Fast OE access time: 3/3.4/3.8 ns
- Fully synchronous operation
- Flow-through or pipelined mode
- Asynchronous output enable control
- Available in 100-pin TQFP and 165-ball BGA package
- Byte write enables
- Clock enable for operation hold
- Multiple chip enables for easy expansion
- 3.3V core power supply
- 2.5V or 3.3V I/O operation with separate V_{DDQ}
- Self-timed write cycles
- Interleaved or linear burst modes
- Snooze mode for standby operation

1. NTD™ is a trademark of Alliance Semiconductor Corporation.

Logic block diagram

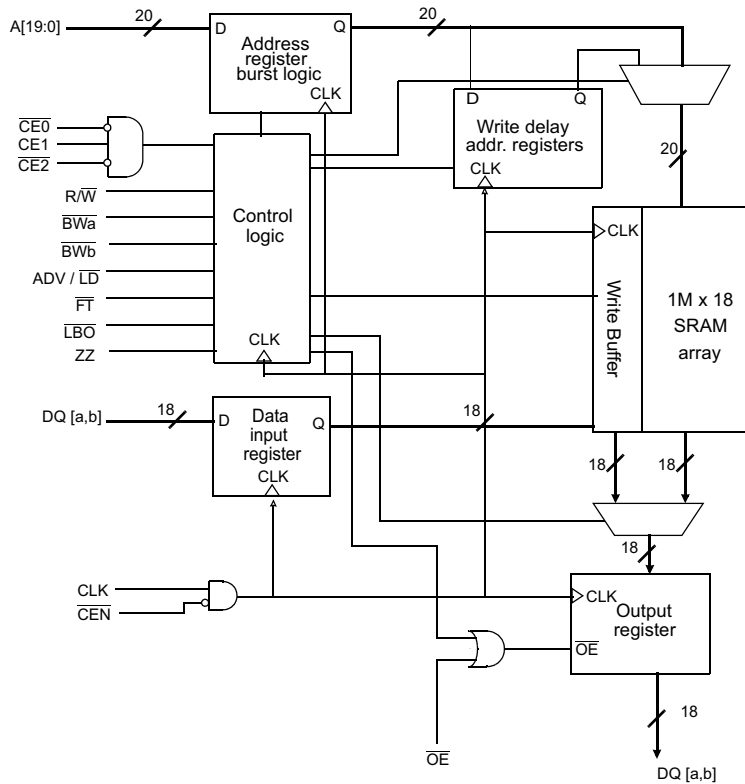

Selection guide

	-200	-166	-133	Units
Minimum cycle time	5	6	7.5	ns
Maximum pipelined clock frequency	200	166	133	MHz
Maximum pipelined clock access time	3.0	3.4	3.8	ns
Maximum operating current	370	340	320	mA
Maximum standby current	130	120	110	mA
Maximum CMOS standby current (DC)	70	70	70	mA



Pin and ball assignment

165-ball BGA - top view

	1	2	3	4	5	6	7	8	9	10	11
A	NC	A	$\overline{CE0}$	\overline{BWb}	NC	$\overline{CE2}$	\overline{CEN}	ADV/LD	A	A	A
B	NC	A	CE1	NC	\overline{BWa}	CLK	R \overline{W}	\overline{OE}	A	A	NC
C	NC	NC	V _{DDQ}	V _{SS}	V _{SS}	V _{SS}	V _{SS}	V _{SS}	V _{DDQ}	NC	DQP _a
D	NC	DQ _b	V _{DDQ}	V _{DD}	V _{SS}	V _{SS}	V _{SS}	V _{DD}	V _{DDQ}	NC	DQ _a
E	NC	DQ _b	V _{DDQ}	V _{DD}	V _{SS}	V _{SS}	V _{SS}	V _{DD}	V _{DDQ}	NC	DQ _a
F	NC	DQ _b	V _{DDQ}	V _{DD}	V _{SS}	V _{SS}	V _{SS}	V _{DD}	V _{DDQ}	NC	DQ _a
G	NC	DQ _b	V _{DDQ}	V _{DD}	V _{SS}	V _{SS}	V _{SS}	V _{DD}	V _{DDQ}	NC	DQ _a
H	\overline{FT}	NC	NC	V _{DD}	V _{SS}	V _{SS}	V _{SS}	V _{DD}	NC	NC	ZZ
J	DQ _b	NC	V _{DDQ}	V _{DD}	V _{SS}	V _{SS}	V _{SS}	V _{DD}	V _{DDQ}	DQ _a	NC
K	DQ _b	NC	V _{DDQ}	V _{DD}	V _{SS}	V _{SS}	V _{SS}	V _{DD}	V _{DDQ}	DQ _a	NC
L	DQ _b	NC	V _{DDQ}	V _{DD}	V _{SS}	V _{SS}	V _{SS}	V _{DD}	V _{DDQ}	DQ _a	NC
M	DQ _b	NC	V _{DDQ}	V _{DD}	V _{SS}	V _{SS}	V _{SS}	V _{DD}	V _{DDQ}	DQ _a	NC
N	DQP _b	NC	V _{DDQ}	V _{SS}	NC	NC	NC	V _{SS}	V _{DDQ}	NC	NC
P	NC	NC	A	A	TDI	A1 ¹	TDO	A	A	A	NC
R	\overline{LBO}	NC	A	A	TMS	A0 ¹	TCK	A	A	A	A

1 A0 and A1 are the two least significant bits (LSB) of the address field and set the internal burst counter if burst is desired.

100-pin TQFP - top view

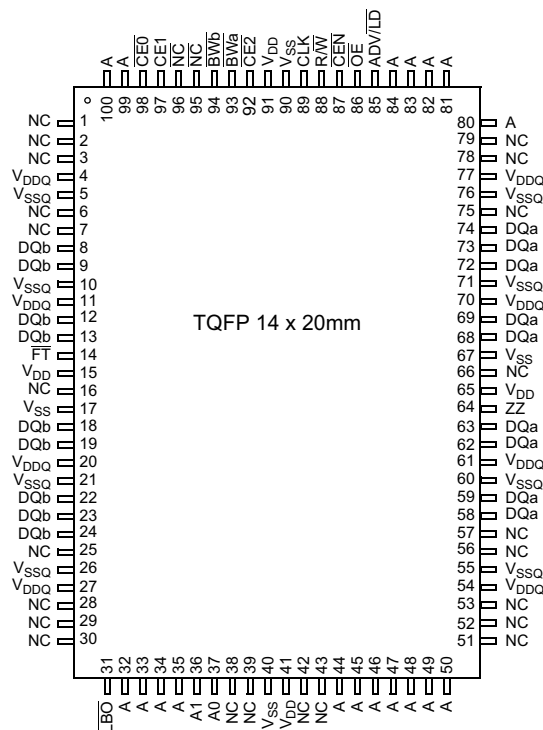



Functional description

The AS7C331MNTD18A family is a high performance CMOS 16 Mbit synchronous Static Random Access Memory (SRAM) organized as 1,048,576 words \times 18 bits and incorporates a LATE LATE Write.

This variation of the 16Mb+ synchronous SRAM uses the No Turnaround Delay (NTDTM) architecture, featuring an enhanced write operation that improves bandwidth over pipelined burst devices. In a normal pipelined burst device, the write data, command, and address are all applied to the device on the same clock edge. If a read command follows this write command, the system must wait for two 'dead' cycles for valid data to become available. These dead cycles can significantly reduce overall bandwidth for applications requiring random access or read-modify-write operations.

NTDTM devices use the memory bus more efficiently by introducing a write latency which matches the two-cycle pipelined or one-cycle flow-through read latency. Write data is applied two cycles after the write command and address, allowing the read pipeline to clear. With NTDTM, write and read operations can be used in any order without producing dead bus cycles.

Assert R/\overline{W} low to perform write cycles. Byte write enable controls write access to specific bytes, or can be tied low for full 18 bit writes. Write enable signals, along with the write address, are registered on a rising edge of the clock. Write data is applied to the device two clock cycles later. Unlike some asynchronous SRAMs, output enable \overline{OE} does not need to be toggled for write operations; it can be tied low for normal operations. Outputs go to a high impedance state when the device is de-selected by any of the three chip enable inputs. In pipelined mode, a two cycle deselect latency allows pending read or write operations to be completed.

Use the ADV (burst advance) input to perform burst read, write and deselect operations. When ADV is high, external addresses, chip select, R/\overline{W} pins are ignored, and internal address counters increment in the count sequence specified by the \overline{LBO} control. Any device operations, including burst, can be stalled using the $\overline{CEN}=1$, the clock enable input.

The AS7C331MNTD18A operates with a $3.3V \pm 5\%$ power supply for the device core (V_{DD}). DQ circuits use a separate power supply (V_{DDQ}) that operates across 3.3V or 2.5V ranges. These devices are available in a 100-pin TQFP package and 165 BGA Ball Grid Array package.

Capacitance

Parameter	Symbol	Signals	Test conditions	Max	Unit
Input capacitance	C_{IN}	Address and control pins	$V_{in} = 0V$	5	pF
I/O capacitance	$C_{I/O}$	I/O pins	$V_{in} = V_{out} = 0V$	7	pF

Burst order

Interleaved burst order $\overline{LBO} = 1$					Linear burst order $\overline{LBO} = 0$				
	A1A0	A1A0	A1A0	A1A0		A1A0	A1A0	A1A0	A1A0
Starting address	0 0	0 1	1 0	1 1	Starting Address	0 0	0 1	1 0	1 1
First increment	0 1	0 0	1 1	1 0	First increment	0 1	1 0	1 1	0 0
Second increment	1 0	1 1	0 0	0 1	Second increment	1 0	1 1	0 0	0 1
Third increment	1 1	1 0	0 1	0 0	Third increment	1 1	0 0	0 1	1 0



Signal descriptions

Signal	I/O	Properties	Description
CLK	I	CLOCK	Clock. All inputs except \overline{OE} , FT, \overline{LBO} , and ZZ are synchronous to this clock.
\overline{CEN}	I	SYNC	Clock enable. When de-asserted high, the clock input signal is masked.
A, A0, A1	I	SYNC	Address. Sampled when all chip enables are active and $\overline{ADV}/\overline{LD}$ is asserted.
DQ[a,b]	I/O	SYNC	Data. Driven as output when the chip is enabled and \overline{OE} is active.
$\overline{CE0}$, CE1, $\overline{CE2}$	I	SYNC	Synchronous chip enables. Sampled at the rising edge of CLK, when $\overline{ADV}/\overline{LD}$ is asserted. Are ignored when $\overline{ADV}/\overline{LD}$ is high.
$\overline{ADV}/\overline{LD}$	I	SYNC	Advance or Load. When sampled high, the internal burst address counter will increment in the order defined by the \overline{LBO} input value. (refer to table on page 2) When low, a new address is loaded.
R/ \overline{W}	I	SYNC	A high during LOAD initiates a READ operation. A low during LOAD initiates a WRITE operation. Is ignored when $\overline{ADV}/\overline{LD}$ is high.
BW[a,b]	I	SYNC	Byte write enables. Used to control write on individual bytes. Sampled along with WRITE command and BURST WRITE.
\overline{OE}	I	ASYNC	Asynchronous output enable. I/O pins are not driven when \overline{OE} is inactive.
\overline{LBO}	I	STATIC	Count mode. When driven high, count sequence follows Intel XOR convention. When driven low, count sequence follows linear convention. This input should be static when the device is in operation.
FT	I	STATIC	Flow-through mode. When low, enables single register flow-through mode. Connect to V_{DD} if unused or for pipelined operation.
TDO	O	SYNC	Serial data-out to the JTAG circuit. Delivers data on the negative edge of TCK. (BGA only)
TDI	I	SYNC	Serial data-in to the JTAG circuit. Sampled on the rising edge of TCK. (BGA only)
TMS	I	SYNC	This pin controls the Test Access Port state machine. Sampled on the rising edge of TCK. (BGA only)
TCK	O	SYNC	Serial data-out to the JTAG circuit. Delivers data on the negative edge of TCK. (BGA only)
ZZ	I	ASYNC	Snooze. Places device in low power mode; data is retained. Connect to GND if unused.
NC	-	-	No connects.

Absolute maximum ratings

Parameter	Symbol	Min	Max	Unit
Power supply voltage relative to GND	V_{DD} , V_{DDQ}	-0.5	+4.6	V
Input voltage relative to GND (input pins)	V_{IN}	-0.5	$V_{DD} + 0.5$	V
Input voltage relative to GND (I/O pins)	V_{IN}	-0.5	$V_{DDQ} + 0.5$	V
Power dissipation	P_D	-	1.8	W
DC output current	I_{OUT}	-	50	mA
Storage temperature (plastic)	T_{stg}	-65	+150	°C
Temperature under bias (junction)	T_{bias}	-65	+150	°C

Stresses greater than those listed under *Absolute Maximum Ratings* may cause permanent damage to the device. This is a stress rating only, and functional operation of the device at these or any other conditions outside those indicated in the operational sections of this specification is not implied. Exposure to absolute maximum rating conditions may affect reliability.



Synchronous truth table

CE0	CE1	CE2	ADV/LD	R/W	BW[a,b]	OE	CEN	Address source	CLK	Operation
H	X	X	L	X	X	X	L	NA	L to H	Deselect, high-Z
X	L	X	L	X	X	X	L	NA	L to H	Deselect, high-Z
X	X	H	L	X	X	X	L	NA	L to H	Deselect, high-Z
L	H	L	L	H	X	X	L	External	L to H	Begin read
L	H	L	L	L	L	X	L	External	L to H	Begin write
X	X	X	H	X	X ¹	X	L	Burst counter	L to H	Burst ²
X	X	X	X	X	X	X	H	Stall	L to H	Inhibit the CLK

1 Should be low for burst write unless specific bytes need to be inhibited

2 Refer to state diagram below.

Key: X = don't care, L = low, H = high

State diagram for NTD SRAM

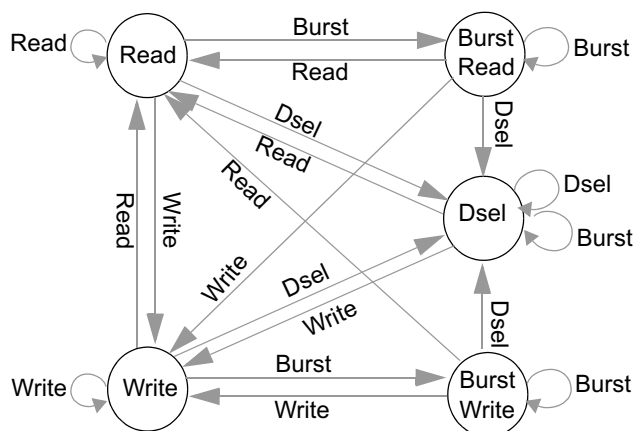

Recommended operating conditions

Parameter	Symbol	Min	Nominal	Max	Unit	
Supply voltage	V _{DD}	3.135	3.3	3.465	V	
	GND	0.0	0.0	0.0		
3.3V I/O supply voltage	V _{DDQ}	2.375	3.3	3.465	V	
	GND _Q	0.0	0.0	0.0		
2.5V I/O supply voltage	V _{DDQ}	2.35	2.5	2.65	V	
	GND _Q	0.0	0.0	0.0		
Input voltages ¹	Address and control pins	V _{IH}	2.0	-	V _{DD} + 0.3	V
		V _{IL}	-0.5 ²	-	0.7	
	I/O pins	V _{IH}	2.0	-	V _{DDQ} + 0.3	V
		V _{IL}	-0.5 ²	-	0.7	
Ambient operating temperature	T _A	0	-	70	°C	

1 Input voltage ranges apply to 3.3V I/O operation. For 2.5V operation, contact factory for input specifications.

2 V_{IL} min = -2.0V for pulse width less than 0.2 x t_{RC}.



DC electrical characteristics for 3.3V I/O operation

Parameter	Sym	Test conditions	200		166		133		Unit
			Min	Max	Min	Max	Min	Max	
Input leakage current ¹	I _{LI}	V _{DD} = Max, V _{in} = GND to V _{DD}	-2	2	-2	2	-2	2	μA
Output leakage current	I _{LO}	$\overline{OE} \geq V_{IH}$, V _{DD} = Max, V _{out} = GND to V _{DD}	-2	2	-2	2	-2	2	μA
Operating power supply current ² (pipelined mode)	I _{CC}	$\overline{CE}_0 = V_{IL}$, CE = V _{IH} , $\overline{CE}_2 = V_{IL}$, f = f _{Max} , I _{OUT} = 0 mA	-	370	-	340	-	320	mA
Operating power supply current ² (flow-through mode)	I _{CC} (FT)	$\overline{CE}_0 = V_{IL}$, CE ₁ = V _{IH} , $\overline{CE}_2 = V_{IL}$, f = f _{Max} , I _{OUT} = 0 mA	-	320	-	275	-	250	mA
Standby power supply current	I _{SB}	Deselected, f = f _{max}	-	130	-	120	-	110	mA
	I _{SB1}	Deselected, f = 0, all V _{IN} ≤ 0.2V or ≥ V _{DD} - 0.2V	-	70	-	70	-	70	
	I _{SB2}	Deselected, f = f _{Max} , ZZ ≥ V _{DD} - 0.2V, all V _{IN} ≤ V _{IL} or ≥ V _{IH}	-	60	-	60	-	60	
Output voltage	V _{OL}	I _{OL} = 8 mA, V _{DDQ} = 3.6V	-	0.4	-	0.4	-	0.4	V
	V _{OH}	I _{OH} = -4 mA, V _{DDQ} = 3.0V	2.4	-	2.4	-	2.4	-	V

¹ LBO, FTX, and ZZX pins and the 165 BGA JTAG pins (TMSX, TDIX, and TCKX) have an internal pull-up, and input leakage = ±10 μA.

² I_{CC} given with no output loading. I_{CC} increases with faster cycle times and greater output loading.

DC electrical characteristics for 2.5V I/O operation

Parameter	Sym	Test conditions	200		166		133		Unit
			Min	Max	Min	Max	Min	Max	
Output leakage current	I _{LO}	$\overline{OE} \geq V_{IH}$, V _{DD} = Max, V _{out} = GND to V _{DD}	-1	1	-1	1	-1	1	μA
Output voltage	V _{OL}	I _{OL} = 2 mA, V _{DDQ} = 2.65V	-	0.7	-	0.7	-	0.7	V
	V _{OH}	I _{OH} = -2 mA, V _{DDQ} = 2.35V	1.7	-	1.7	-	1.7	-	



Timing characteristics over operating range

Parameter	Sym	200		166		133		Unit	Notes ¹
		Min	Max	Min	Max	Min	Max		
Clock frequency	F _{MAX}	–	200	–	166	–	133	MHz	
Cycle time (pipelined mode)	t _{CYC}	5	–	6	–	7.5	–	ns	
Cycle time (flow-through mode)	t _{CYCF}	7.5	–	8.5	–	12	–	ns	
Clock access time (pipelined mode)	t _{CD}	–	3.0	–	3.4	–	3.8	ns	
Clock access time (flow-through mode)	t _{CDF}	–	7.5	–	8.5	–	10	ns	
Output enable low to data valid	t _{OE}	–	3.0	–	3.4	–	3.8	ns	
Clock high to output low Z	t _{LZC}	0	–	0	–	0	–	ns	2, 3, 4
Data output invalid from clock high (pipelined mode)	t _{OH}	1.5	–	1.5	–	1.5	–	ns	2
Data Output invalid from clock high (flow-through mode)	t _{OHF}	3.0	–	3.0	–	3.0	–	ns	2
Output enable low to output low Z	t _{LZOE}	0	–	0	–	0	–	ns	2, 3, 4
Output enable high to output high Z	t _{HZOE}	–	3.0	–	3.4	–	3.8	ns	2, 3, 4
Clock high to output high Z	t _{HZC}	–	3.0	–	3.4	–	3.8	ns	2, 3, 4
Output enable high to invalid output	t _{OHOE}	0	–	0	–	0	–	ns	
Clock high pulse width	t _{CH}	1.8	–	2.4	–	2.4	–	ns	5
Clock low pulse width	t _{CL}	1.8	–	2.3	–	2.4	–	ns	5
Address and Control setup to clock high	t _{AS}	1.4	–	1.5	–	1.5	–	ns	6
Data setup to clock high	t _{DS}	1.4	–	1.5	–	1.5	–	ns	6
Write setup to clock high	t _{WS}	1.4	–	1.5	–	1.5	–	ns	6, 7
Chip select setup to clock high	t _{CSS}	1.4	–	1.5	–	1.5	–	ns	6, 8
Address hold from clock high	t _{AH}	0.4	–	0.5	–	0.5	–	ns	6
Data hold from clock high	t _{DH}	0.4	–	0.5	–	0.5	–	ns	6
Write hold from clock high	t _{WH}	0.4	–	0.5	–	0.5	–	ns	6, 7
Chip select hold from clock high	t _{CSH}	0.4	–	0.5	–	0.5	–	ns	6, 8
Clock enable setup to clock high	t _{CENS}	1.4	–	1.5	–	1.5	–	ns	6
Clock enable hold from clock high	t _{CENH}	0.4	–	0.5	–	0.5	–	ns	6
ADV setup to clock high	t _{ADVS}	1.4	–	1.5	–	1.5	–	ns	6
ADV hold from clock high	t _{ADVH}	0.4	–	0.5	–	0.5	–	ns	6

¹ See "Notes" on page 17



IEEE 1149.1 serial boundary scan (JTAG)

The SRAM incorporates a serial boundary scan test access port (TAP). The port operates in accordance with IEEE Standard 1149.1-1990 but does not have the set of functions required for full 1149.1 compliance. The inclusion of these functions would place an added delay in the critical speed path of the SRAM. The TAP controller functionality does not conflict with the operation of other devices using 1149.1 fully compliant TAPs. It uses JEDEC-standard 2.5V I/O logic levels.

The SRAM contains a TAP controller, instruction register, boundary scan register, bypass register, and ID register.

Disabling the JTAG feature

If the JTAG function is not being implemented, its pins/balls can be left unconnected. At power-up, the device will come up in a reset state which will not interfere with the operation of the device.

TAP controller state diagram

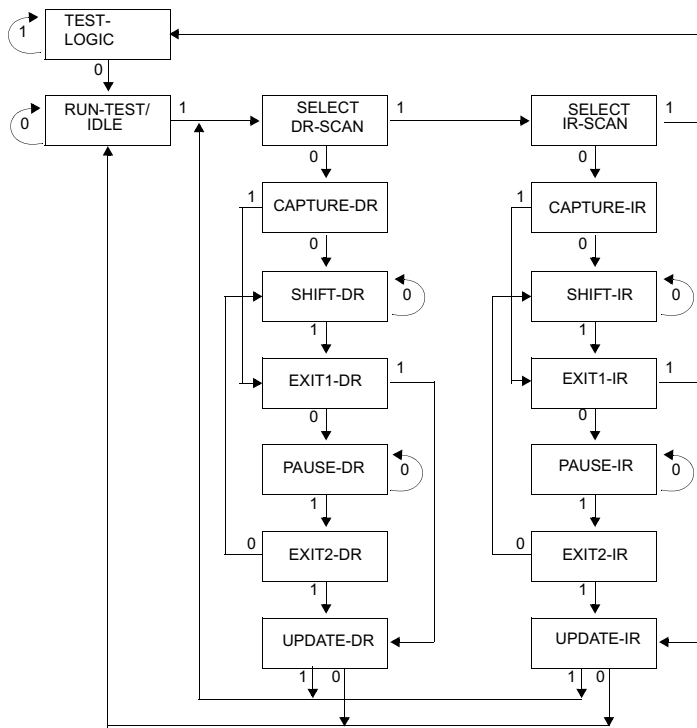

Note: The 0 or 1 next to each state represents the value of TMS at the rising edge of TCK.

TAP controller block diagram

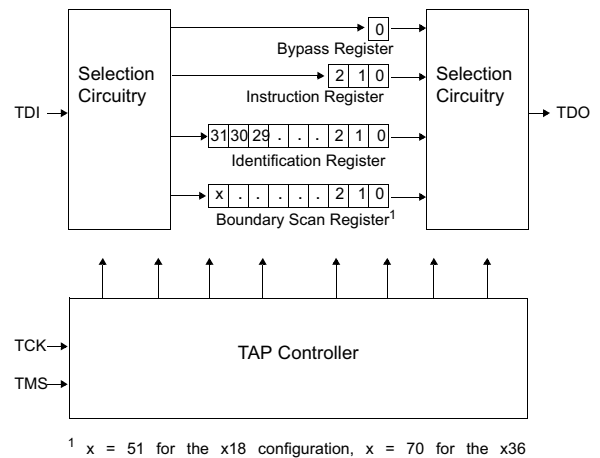

¹ x = 51 for the x18 configuration, x = 70 for the x36

Test access port (TAP)

Test clock (TCK)

The test clock is used with only the TAP controller. All inputs are captured on the rising edge of TCK. All outputs are driven from the falling edge of TCK.

Test mode select (TMS)

The TAP controller receives commands from TMS input. It is sampled on the rising edge of TCK. You can leave this pin/ball unconnected if the TAP is not used. The pin/ball is pulled up internally, resulting in a logic high level.



Test data-in (TDI)

The TDI pin/ball serially inputs information into the registers and can be connected to the input of any of the registers. The register between TDI and TDO is chosen by the instruction that is loaded into the TAP instruction register. For information on loading the instruction register, see the TAP Controller State Diagram. TDI is internally pulled up and can be unconnected if the TAP is unused in an application. TDI is connected to the most significant bit (MSB) of any register. (See the TAP Controller Block Diagram.)

Test data-out (TDO)

The TDO output pin/ball serially clocks data-out from the registers. The output is active depending upon the current state of the TAP state machine. The output changes on the falling edge of TCK. TDO is connected to the least significant bit (LSB) of any register. (See the TAP Controller State Diagram.)

Performing a TAP RESET

You can perform a RESET by forcing TMS high (V_{DD}) for five rising edges of TCK. This RESET does not affect the operation of the SRAM and can be performed while the SRAM is operating

At power-up, the TAP is reset internally to ensure that TDO comes up in a high-Z state.

TAP registers

Registers are connected between the TDI and TDO pins/balls. They allow data to be scanned into and out of the SRAM test circuitry. Only one register can be selected at a time through the instruction register. Data is serially loaded into the TDI pin/ball on the rising edge of TCK. Data is output on the TDO pin/ball on the falling edge of TCK.

Instruction register

You can serially load three-bit instructions into the instruction register. The register is loaded when it is placed between the TDI and TDO pins/balls as shown in the TAP Controller Block Diagram. The instruction register is loaded with the IDCODE instruction at power up and also if the controller is placed in a reset state, as described in the previous section.

When the TAP controller is in the Capture-IR state, the two least significant bits are loaded with a binary “01” pattern to allow for fault isolation of the board-level series test data path.

Bypass register

To save time when serially shifting data through registers, it is sometimes advantageous to skip certain chips. The bypass register is a single-bit register that can be placed between the TDI and TDO pins/balls. This allows data to be shifted through the SRAM with minimal delay. The bypass register is set low (V_{ss}) when the BYPASS instruction is executed.

Boundary scan register

The boundary scan register is connected to all the input and bidirectional pins/balls on the SRAM. The x36 configuration has a 70-bit-long register and the x18 configuration has a 51-bit-long register.

The boundary scan register is loaded with the contents of the RAM I/O ring when the TAP controller is in the Capture-DR state and is then placed between the TDI and TDO pins/balls when the controller is moved to the Shift-DR state. The EXTTEST, SAMPLE/RELOAD, and SAMPLE Z instructions can be used to capture the contents of the I/O ring

The boundary scan order table shows the order in which the bits are connected. Each bit corresponds to one of the bumps on the SRAM package. The most significant bit (MSB) of the register is connected to TDI, and the least significant bit (LSB) is connected to TDO.

Identification (ID) register

The ID register has a vendor code and other information described in the Identification Register Definitions table. The ID register is loaded with a vendor-specific, 32-bit code during the Capture-DR state when the IDCODE command is loaded in the instruction register. The IDCODE is hardwired into the SRAM and can be shifted out when the TAP controller is in the Shift-DR state.



TAP instruction set

Eight different instructions are possible with the 3-bit instruction register. All combinations are listed in the Instruction Codes table. Three of these instructions are reserved and should not be used.

Note that the TAP controller used in this SRAM is not fully compliant to the 1149.1 convention because some of the mandatory 1149.1 instructions are not fully implemented. The TAP controller cannot be used to load address, data, or control signals into the SRAM and cannot preload the I/O buffers. The SRAM does not implement the 1149.1 commands EXTEST or INTEST or the PRELOAD portion of SAMPLE/PRELOAD. Instead, it performs a capture of the I/O ring when these instructions are executed.

Instructions are loaded into the TAP controller during the Shift-IR state when the instruction register is placed between TDI and TDO. During this state, instructions are shifted through the instruction register through the TDI and TDO pins/balls. To execute the instruction once it is shifted in, the TAP controller needs to be moved into the Update-IR state.

EXTEST

The EXTEST instruction, which executes whenever the instruction register is loaded with all 0s, is not implemented in this SRAM TAP controller. The TAP controller, however, does recognize an all-0 instruction. When an EXTEST instruction is loaded into the instruction register, the SRAM responds as if a SAMPLE/PRELOAD instruction has been loaded. Unlike the SAMPLE/PRELOAD instruction, EXTEST places the SRAM outputs in a high-Z state.

EXTEST is a mandatory 1149.1 instruction. this device, therefore, is not compliant with 1149.1.

IDCODE

The IDCODE instruction is loaded into the instruction register upon power-up or whenever the TAP controller is given a test logic reset state. The IDCODE instruction causes a vendor-specific, 32-bit code to be loaded into the instruction register. It also places the instruction register between the TDI and TDO pins/balls and allows the IDCODE to be shifted out of the device when the TAP controller enters the Shift-DR state.

SAMPLE Z

The SAMPLE Z instruction causes the boundary scan register to be connected between the TDI and TDO pins/balls when the TAP controller is in a Shift-DR state. It also places all SRAM outputs into a high-Z state.

SAMPLE/PRELOAD

When the SAMPLE/PRELOAD instruction is loaded into the instruction register and the TAP controller is in the Capture-DR state, a snapshot of data on the inputs and bidirectional pins/balls is captured in the boundary scan register. Note that the SAMPLE/PRELOAD is a 1149.1 mandatory instruction, but the PRELOAD portion of this instruction is not implemented in this device. The TAP controller, therefore, is not fully 1149.1 compliant.

Be aware that the TAP controller clock can operate only at a frequency up to 10 Mhz, while the SRAM clock operates more than an order of magnitude faster. Because there is a large difference in the clock frequencies, it is possible that during the Capture-DR state, an input or output can undergo a transition. The TAP may then try to capture a signal while in transition (metastable state). This will not harm the device, but there is no guarantee as to the value that will be captured. Repeatable results may not be possible.

To guarantee that the boundary scan register captures the correct value of a signal, the SRAM signal must be stabilized long enough to meet the TAP controller's capture setup plus hold time (t_{CS} plus t_{CH}). The SRAM clock input might not be captured correctly if there is no way in a design to stop (or slow) the clock during a SAMPLE/PRELOAD instruction. If this is an issue, it is possible to capture all other signals and ignore the value of the CK and CK# captured in the boundary scan register.

Once the data is captured, it is possible to shift out the data by putting the TAP into the Shift-DR state. This places the boundary scan register between the TDI and TDO pins.

Note that since the PRELOAD part of the command is not implemented, putting the TAP to the Update-DR state while performing a SAMPLE/PRELOAD instruction will have the same effect as the Pause-DR command.

BYPASS

The advantage of the BYPASS instruction is that it shortens the boundary scan path when multiple devices are connected together on a board. When the BYPASS instruction is loaded in the instruction register and the TAP is placed in a Shift-DR state, the bypass register is placed between TDI and TDO.



Reserved

Do not use a reserved instruction. These instructions are not implemented but are reserved for future use.

TAP timing diagram

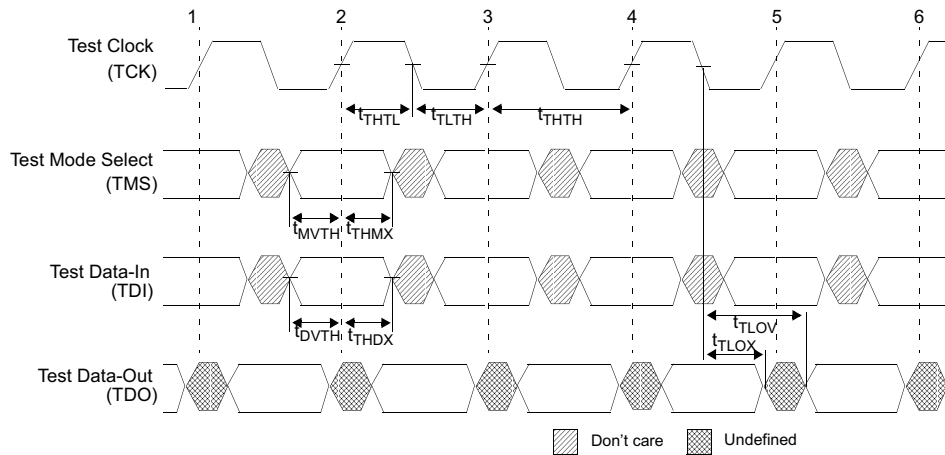

TAP AC electrical characteristics

For notes 1 and 2, $+10^{\circ}\text{C} \leq T_j \leq +110^{\circ}\text{C}$ and $+2.4\text{V} \leq V_{DD} \leq +2.6\text{V}$.

Description	Symbol	Min	Max	Units
Clock				
Clock cycle time	t_{THTH}	100		ns
Clock frequency	f_{TF}		10	MHz
Clock high time	t_{THTL}	40		ns
Clock low time	t_{TLTH}	40		ns
Output Times				
TCK low to TDO unknown	t_{TLOX}	0		ns
TCK low to TDO valid	t_{TLOV}		20	ns
TDI valid to TCK high	t_{DVTH}	10		ns
TCK high to TDI invalid	t_{THDX}	10		ns
Setup Times				
TMS setup	t_{MVTH}	10		ns
Capture setup	t_{CS}^1	10		ns
Hold Times				
TMS hold	t_{THMX}	10		ns
Capture hold	t_{CH}^1	10		ns

¹ t_{CS} and t_{CH} refer to the setup and hold time requirements of latching data from the boundary scan register.

² Test conditions are specified using the load in the figure TAP AC output load equivalent.



TAP AC test conditions

Input pulse levels. Vss to 2.5V
 Input rise and fall times. 1 ns
 Input timing reference levels. 1.25V
 Output reference levels 1.25V
 Test load termination supply voltage. . . . 1.25V

TAP AC output load equivalent

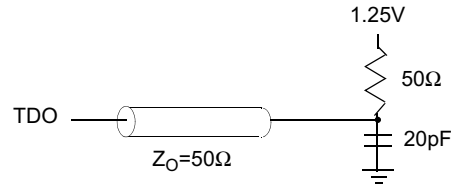

3.3V V_{DD} TAP DC electrical characteristics and operating conditions

(+10°C ≤ T_J ≤ +110°C and +3.135V ≤ V_{DD} ≤ +3.465V unless otherwise noted)

Description	Conditions	Symbol	Min	Max	Units	Notes
Input high (logic 1) voltage		V _{IH}	2.0	V _{DD} + 0.3	V	1, 2
Input low (logic 0) voltage		V _{IL}	-0.3	0.8	V	1, 2
Input leakage current	0V ≤ V _{IN} ≤ V _{DD}	I _{LI}	-5.0	5.0	μA	
Output leakage current	Outputs disabled, 0V ≤ V _{IN} ≤ V _{DDQ} (DQx)	I _{LO}	-5.0	5.0	μA	
Output low voltage	I _{OLC} = 100μA	V _{OL1}		0.7	V	1
Output low voltage	I _{OLT} = 2mA	V _{OL2}		0.8	V	1
Output high voltage	I _{OHS} = -100μA	V _{OH1}	2.9		V	1
Output high voltage	I _{OHT} = -2mA	V _{OH2}	2.0		V	1

2.5V V_{DD} TAP DC electrical characteristics and operating conditions

(+10°C ≤ T_J ≤ +110°C and +2.4V ≤ V_{DD} ≤ +2.6V unless otherwise noted)

Description	Conditions	Symbol	Min	Max	Units	Notes
Input high (logic 1) voltage		V _{IH}	1.7	V _{DD} + 0.3	V	1, 2
Input low (logic 0) voltage		V _{IL}	-0.3	0.7	V	1, 2
Input leakage current	0V ≤ V _{IN} ≤ V _{DD}	I _{LI}	-5.0	5.0	μA	
Output leakage current	Outputs disabled, 0V ≤ V _{IN} ≤ V _{DDQ} (DQx)	I _{LO}	-5.0	5.0	μA	
Output low voltage	I _{OLC} = 100μA	V _{OL1}		0.2	V	1
Output low voltage	I _{OLT} = 2mA	V _{OL2}		0.7	V	1
Output high voltage	I _{OHS} = -100μA	V _{OH1}	2.1		V	1
Output high voltage	I _{OHT} = -2mA	V _{OH2}	1.7		V	1

1. All voltage referenced to V_{SS}(GND).

2. Overshoot: V_{IH}(AC) ≤ V_{DD} + 1.5V for t ≤ t_{KHKH}/2

Undershoot: V_{IL}(AC) ≥ -0.5 for t ≤ t_{KHKH}/2

Power-up: V_{IH} ≤ +2.6V and V_{DD} ≤ 2.4V and V_{DDQ} ≤ 1.4V for t ≤ 200ms

During normal operation, V_{DDQ} must not exceed V_{DD}. Control input signals (such as $\overline{\text{LD}}$, R/ $\overline{\text{W}}$, etc.) may not have pulsed widths less than t_{KHKL}(Min) or operate at frequencies exceeding f_{KF}(Max).



Identification register definitions

Instruction field	1M x 18	Description
Revision number (31:28)	xxxx	Reserved for version number.
Device depth (27:23)	xxxxx	Defines the depth of 1Mb words.
Device width (22:18)	xxxxx	Defines the width of x18 bits.
Device ID (17:12)	xxxxxx	Reserved for future use.
JEDEC ID code (11:1)	00000110100	Allows unique identification of SRAM vendor.
ID register presence indicator (0)	1	Indicates the presence of an ID register.

Scan register sizes

Register name	Bit size	
Instruction	3	
Bypass	1	
ID	32	
Boundary scan	x18:51	x36:70

Instruction codes

Instruction	Code	Description
EXTEST	000	Captures I/O ring contents. Places the boundary scan register between TDI and TDO. Forces all SRAM outputs to high-Z state. This instruction is not 1149.1-compliant.
IDCODE	001	Loads the ID register with the vendor ID code and places the register between TDI and TDO. This operation does not affect SRAM operations.
SAMPLE Z	010	Captures I/O ring contents. Places the boundary scan register between TDI and TDO. Forces all SRAM output drivers to a high-Z state.
Reserved	011	Do not use. This instruction is reserved for future use.
SAMPLE/PRELOAD	100	Captures I/O ring contents. Places the boundary scan register between TDI and TDO. Does not affect SRAM operation. This instruction does not implement 1149.1 preload function and is therefore not 1149.1-compliant.
Reserved	101	Do not use. This instruction is reserved for future use.
Reserved	110	Do not use. This instruction is reserved for future use.
BYPASS	111	Places the bypass register between TDI and TDO. This operation does not affect SRAM operations.



165-ball BGA boundary scan order (x18)

Bit #s	Signal Name	Ball ID
1	SA	8P
2	SA	9R
3	SA	9P
4	SA	10R
5	SA	10P
6	SA	11R
7	SA	8R
8	DQa	10M
9	DQa	10L
10	DQa	10K
11	DQa	10J
12	ZZ	11H
13	DQa	11G
14	DQa	11F
15	DQa	11E
16	DQa	11D
17	DQPa	11C
18	SA	11A
19	SA	10B
20	SA	10A
21	SA	9A
22	SA	9B
23	ADV/LD	8A
24	OE	8B
25	CEN	7A
26	R/W	7B
27	CLK	6B

Bit #s	Signal Name	Ball ID
28	CEZ	6A
29	BW \bar{a}	5B
30	BW \bar{b}	4A
31	CE1	3B
32	CE $\bar{0}$	3A
33	SA	2A
34	SA	2B
35	DQb	2D
36	DQb	2E
37	DQb	2F
38	DQb	2G
39	FT	1H
40	DQb	1J
41	DQb	1K
42	DQb	1L
43	DQb	1M
44	DQPb	1N
45	LB $\bar{0}$	1R
46	SA	3P
47	SA	3R
48	SA	4P
49	SA	4R
50	SA1	6P
51	SA0	6R
52	-	
53	-	



Key to switching waveforms

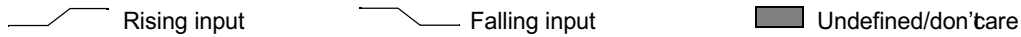

Timing waveform of read/write cycle

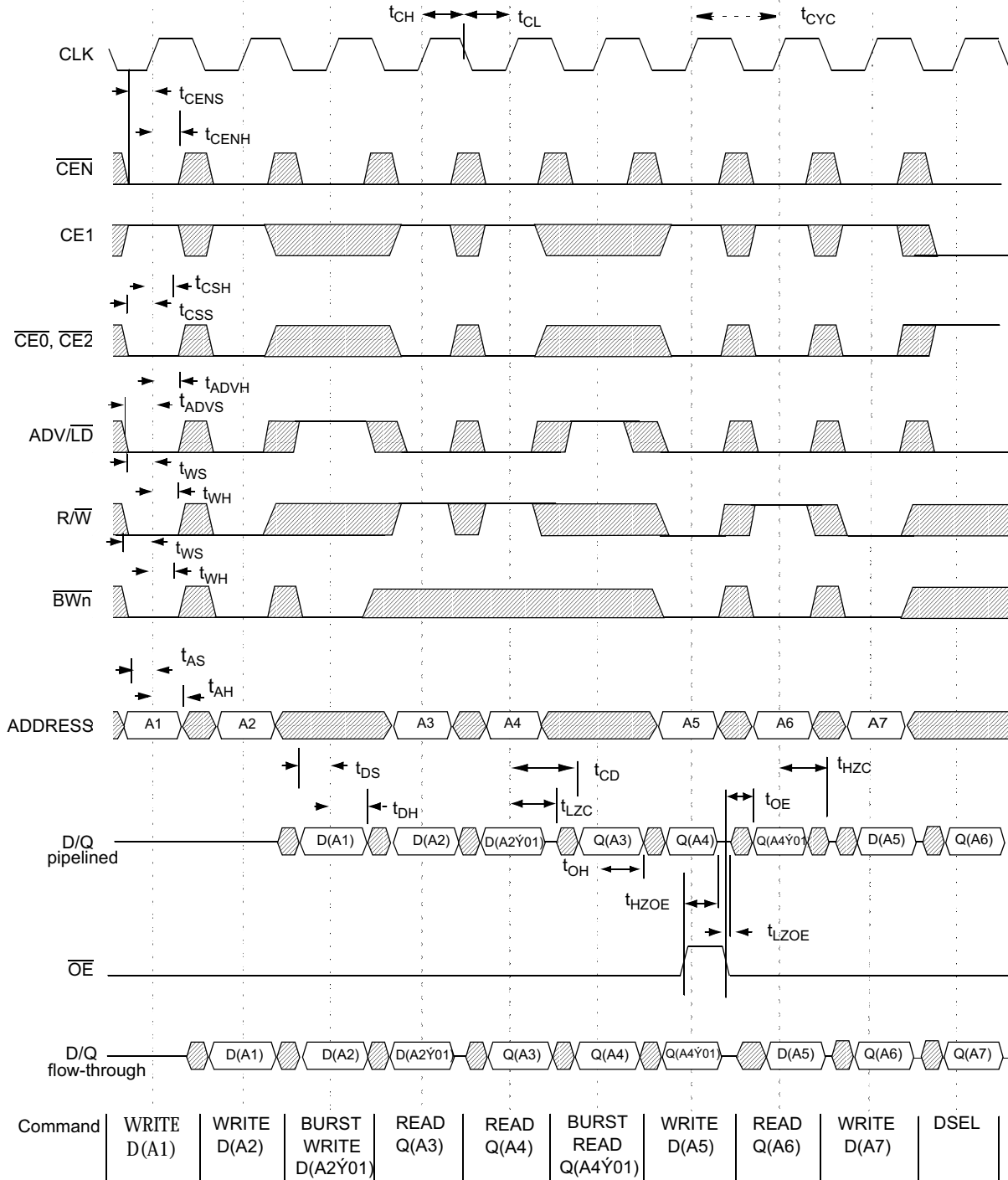

Note: Y = XOR when \overline{LBO} = high/No Connect; Y = ADD when \overline{LBO} = low. $\overline{BW[a:b]}$ is don't care.



NOP, stall and deselect cycles

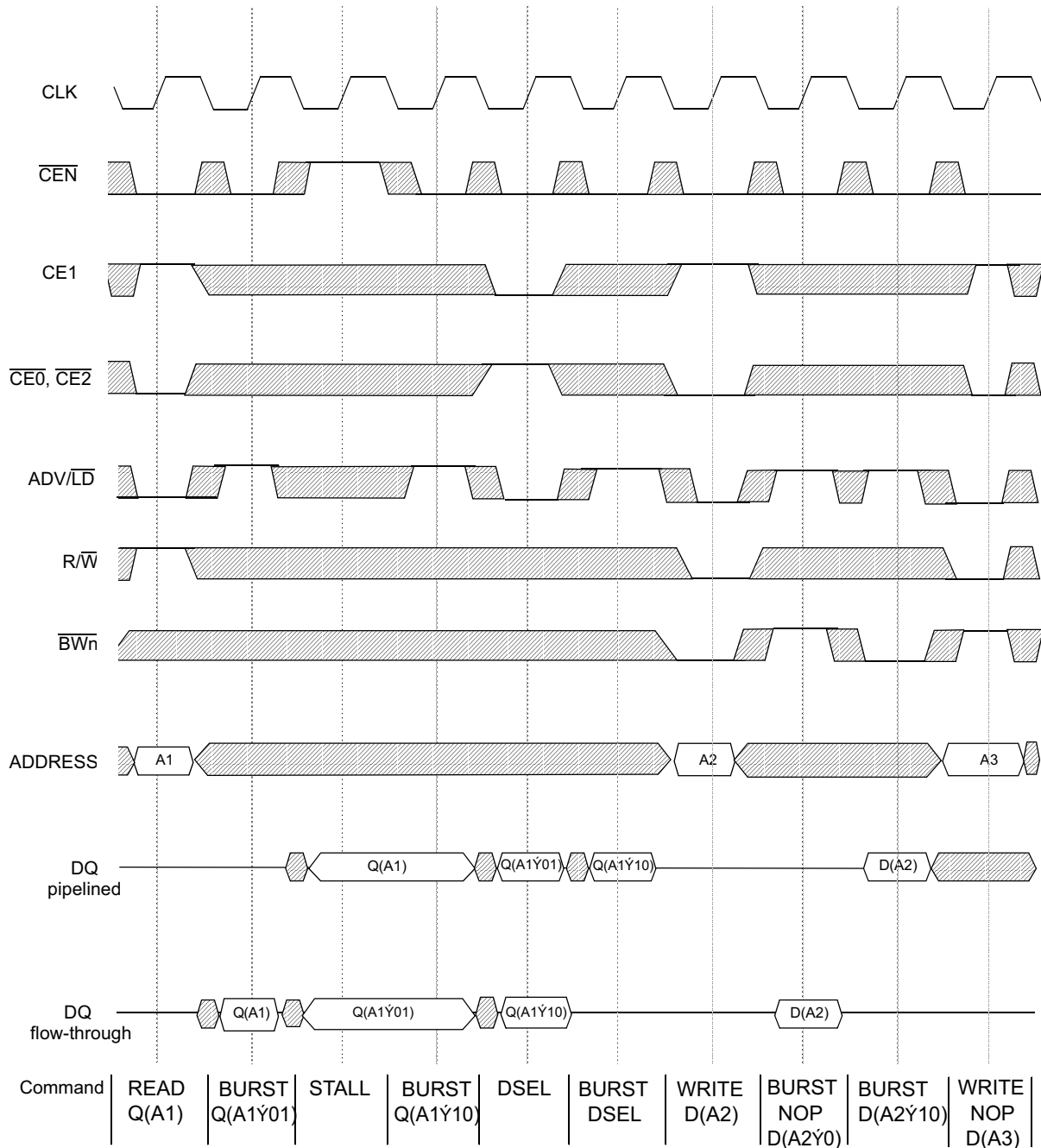

Note: \dot{Y} = XOR when \overline{LBO} = high/No Connect; \dot{Y} = ADD when \overline{LBO} = low. \overline{OE} is low.



AC test conditions

- Output load: see Figure B, except for t_{LZC} , t_{LZOE} , t_{HZOE} , t_{HZC} , see Figure C.
- Input pulse level: GND to 3V. See Figure A.
- Input rise and fall time (measured at 0.3V and 2.7V): 2 ns. See Figure A.
- Input and output timing reference levels: 1.5V.

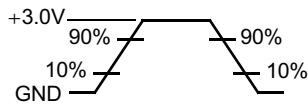

Figure A: Input waveform

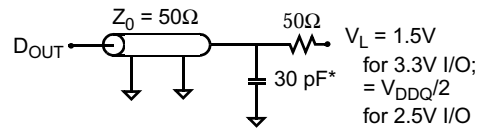

Figure B: Output load (A)

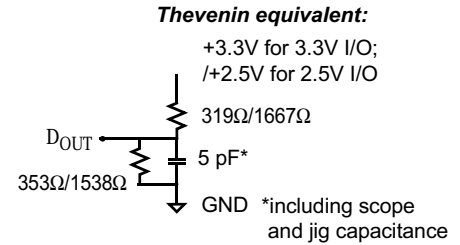

Figure C: Output load(B)

Notes:

- 1) For test conditions, see "AC test conditions", Figures A, B, C
- 2) This parameter measured with output load condition in Figure C.
- 3) This parameter is sampled, but not 100% tested.
- 4) t_{HZOE} is less than t_{LZOE} and t_{HZC} is less than t_{LZC} at any given temperature and voltage.
- 5) t_{CH} measured high above V_{IH} and t_{CL} measured as low below V_{IL}
- 6) This is a synchronous device. All addresses must meet the specified setup and hold times for all rising edges of CLK. All other synchronous inputs must meet the setup and hold times with stable logic levels for all rising edges of CLK when chip is enabled.
- 7) Write refers to R/W and $BW[a,b]$.
- 8) Chip select refers to $CE0$, $CE1$, and $CE2$.



Package dimensions

100-pin quad flat pack (TQFP)

	TQFP	
	Min	Max
A1	0.05	0.15
A2	1.35	1.45
b	0.22	0.38
c	0.09	0.20
D	13.90	14.10
E	19.90	20.10
e	0.65 nominal	
Hd	15.90	16.10
He	21.90	22.10
L	0.45	0.75
L1	1.00 nominal	
α	0°	7°
Dimensions in millimeters		

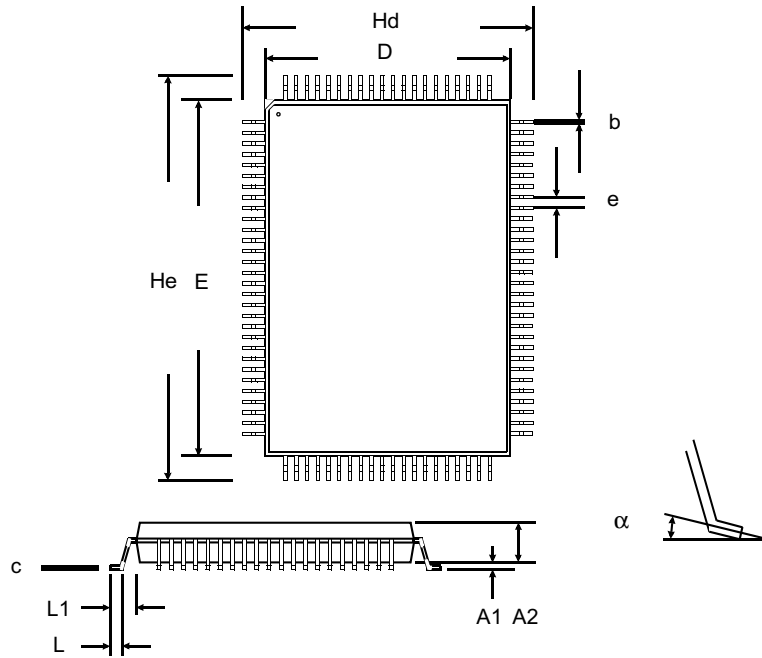

165-ball BGA (ball grid array)

All measurements are in mm.

	Min	Typ	Max
A		1.00	
B	14.90	15.00	15.10
C		14.00	
D	12.90	13.00	13.10
E		10.00	
F		0.26	
G	0.30	0.35	0.40
H			1.20
I	0.40	0.45	0.50

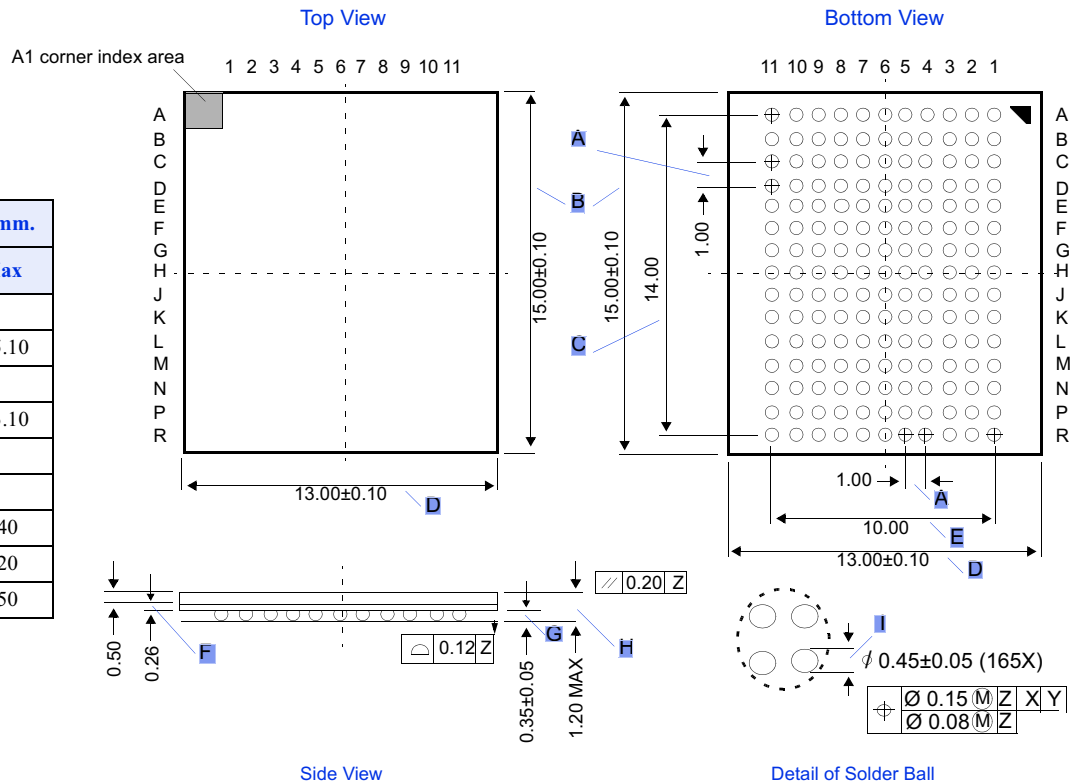



Ordering information

Package & Width	-200 MHz	-166 MHz	-133 MHz
TQFP x18	AS7C331MNTD18A-200TQC	AS7C331MNTD18A-166TQC	AS7C331MNTD18A-133TQC
	AS7C331MNTD18A-200TQI	AS7C331MNTD18A-166TQI	AS7C331MNTD18A-133TQI
BGA x18	AS7C331MNTD18A-200BC	AS7C331MNTD18A-166BC	AS7C331MNTD18A-133BC
	AS7C331MNTD18A-200BI	AS7C331MNTD18A-166BI	AS7C331MNTD18A-133BI

Part numbering guide

AS7C	33	1M	NTD	18	A	-XXX	TQ or B	C/I
1	2	3	4	5	6	7	8	9

- Alliance Semiconductor SRAM prefix
- Operating voltage: 33 = 3.3V
- Organization: 1M
- NTD™ = No Turn-Around Delay. Pipelined/flow-through mode (each device works in both modes)
- Organization: 18 = x 18
- Production version: A = first production version
- Clock speed (MHz)
- Package type: TQ = TQFP; B = BGA
- Operating temperature: C = commercial (0° C to 70° C); I = industrial (-40° C to 85° C)