

SiGe-Power Amplifier for GSM 900 (Flipchip Version)



Description

The TST0922 is a monolithic integrated power amplifier IC in flipchip technology. The device is manufactured using TEMIC Semiconductors' Silicon-Germanium (SiGe) technology and has been designed for use in GSM 900 MHz mobile phones.

leakage current in power-down mode the TST0922 needs few external components and no high-side switch transistor which reduces system cost.

With a single supply voltage of 3 V and a neglectable

Features

- 34.5 dBm output power
- Power Added Efficiency (PAE) 50 %
- Single-supply operation at 3 V no negative voltage necessary
- Current consumption in power-down mode $\leq 10 \mu\text{A}$
- No external power-supply switch required
- Power-ramp control
- Simple output matching for maximum flexibility
- Flipchip package

Block Diagram

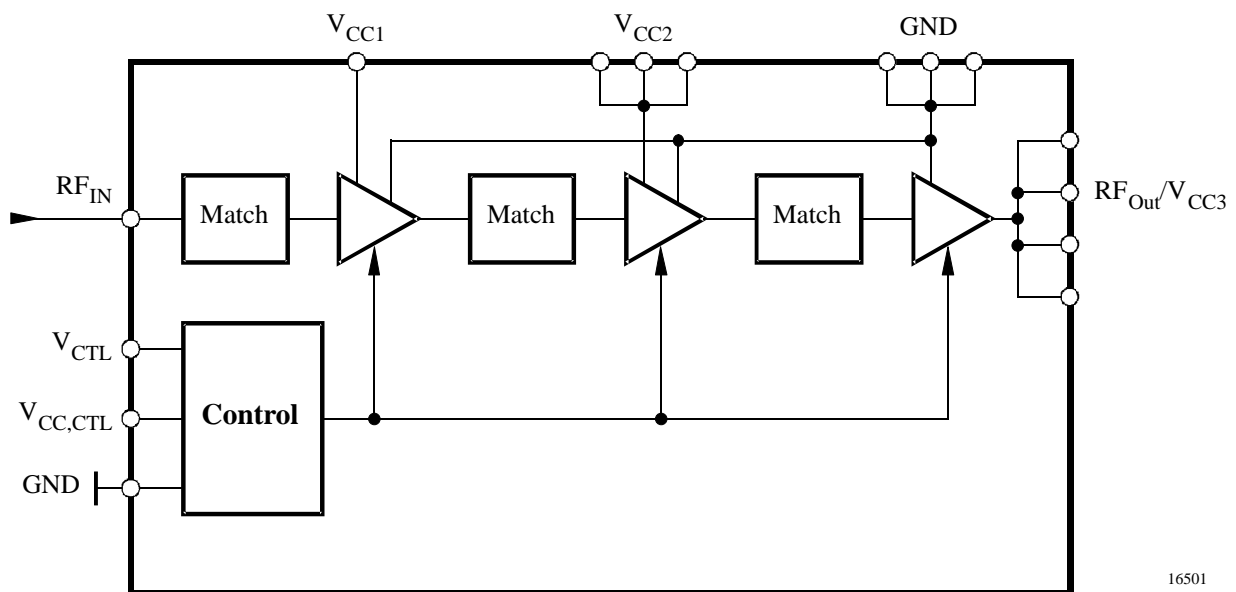

Figure 1. Block diagram

Ordering Information

Extended Type Number	Package	Remarks
TST0922-MDD	Flipchip	

Pad Description

Pad	Symbol	Function	X-Coordinate of Pad *) (μm)	Y-Coordinate of Pad *) (μm)
1	Vcc1	Supply voltage 1	0	1500
2	RFin	RF input	0	1000
3	VCCctrl	Supply voltage for control	0	500
4	VCTL	Control input	0	0
5	Vcc2	Supply voltage 2	500	1630
6	GND	Ground	500	891
7	GND	Ground	500	142
8	GND	Ground	900	1630
9	GND	Ground	1527	1630
10	GND	Ground	1527	1230
11	GND	Ground	1527	830
12	GND	Ground	1527	430
13	GND	Ground	1527	30
14	RFout/ Vcc3	RF output/ supply voltage 3	2474	1391
15	RFout/ Vcc3	RF output/ supply voltage 3	2474	991
16	RFout/ Vcc3	RF output/ supply voltage 3	2474	591
17	RFout/ Vcc3	RF output/ supply voltage 3	2474	191

*) Relative to centre of Pad 4

Pad Location

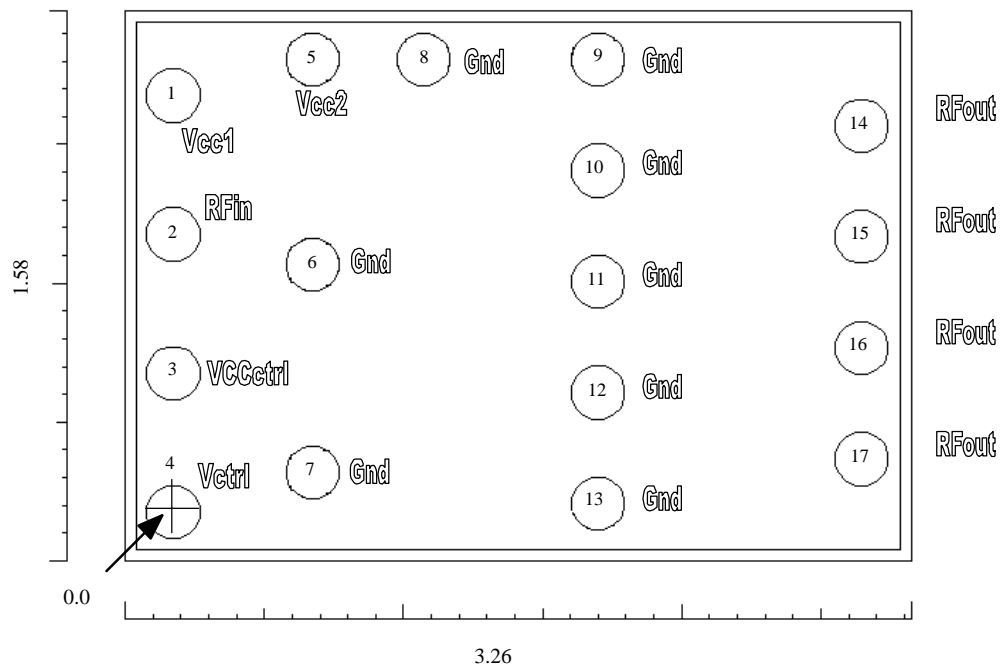

Dimensions-scale division = 100 μm, for pad coordinates see Pad Description table.

Figure 2. Pad location

Absolute Maximum Ratings

All voltages are referred to GND

Parameter	Symbol	Min.	Typ.	Max.	Unit
Supply voltage	V _{CC}			5.0	V
Input power	P _{in}			13	dBm
Gain control voltage	V _{CTL}	0		2.2	V
Duty cycle for operation				25	%
Burst duration	T _{burst}			1.2	ms
Junction temperature	T _j			+150	°C
Storage temperature	T _{stg}	-40		+150	°C

Thermal Resistance

Parameters	Symbol	Value	Unit
		tdb	

Operating Range

Parameter	Symbol	Min.	Typ.	Max.	Unit
Supply voltage	V _{CC1} V _{CC2} V _{CC3} V _{CC,CTL}	2.4	3.5	4.5	V
Ambient temperature	T _{amb}	-25		+85	°C
Input frequency	f _{in}		900		MHz

Electrical Characteristics

Test conditions: V_{CC} = V_{CC1},....., V_{CC3}, V_{CC, CTL} = + 3.5 V, T_{amb} = + 25°C (see application circuit)

Parameters	Test Conditions	Symbol	Min.	Typ.	Max.	Unit
Power Supply						
Supply voltage		V _{CC}	2.4	3.5	4.5	V
Current consumption	Active mode P _{out} = 34.5 dBm, PAE = 50%	I		1.70		A
Current consumption (leakage current)	Power-down mode V _{CTL} ≤ 0.2 V	I			10	μA
RF Input						
Frequency range		f _{in}	880	900	915	MHz
Input impedance *		Z _i		50		Ω
Input power		P _{in}		3	12	dBm
Input VSWR *	P _{in} = 0 to 12 dBm, P _{out} = 34.5 dBm				2 : 1	

* With external matching, see application circuit

Electrical Characteristics (continued)

Test conditions: $V_{CC} = V_{CC1}, \dots, V_{CC3}, V_{CC}, V_{CTL} = +3.5 \text{ V}$, $T_{amb} = +25^\circ\text{C}$ (see application circuit)

Parameters	Test Conditions	Symbol	Min.	Typ.	Max.	Unit
RF Output						
Output impedance *		Z_o		50		Ω
Output power: normal conditions	$V_{CC} = 3.5 \text{ V}$, $T_{amb} = +25^\circ\text{C}$ $P_{in} = 3 \text{ dBm}$, $R_L = R_G = 50 \Omega$	P_{out}	34.4	34.8		dBm
	extreme conditions	$V_{CC} = 2.7 \text{ V}$, $T_{amb} = +85^\circ\text{C}$ $P_{in} = 3 \text{ dBm}$, $R_L = R_G = 50 \Omega$	P_{out}	32.0	33.0	
Minimum output power	$V_{CTL} = 0.3 \text{ V}$			-20		dBm
Power added efficiency	$V_{CC} = 3 \text{ V}$, $P_{out} = 28 \text{ dBm}$ $V_{CC} = 3 \text{ V}$, $P_{out} = 30 \text{ dBm}$ $V_{CC} = 3 \text{ V}$, $P_{out} = 33.5 \text{ dBm}$	PAE	25 35 50			%
Stability	$T_{amb} = -25 \text{ to } +85^\circ\text{C}$, no spurious $\geq -60 \text{ dBc}$				10 : 1	
Load mismatch (stable, no change)	$P_{out} = 34.5 \text{ dBm}$, all phases, no damage	VSWR			10 : 1	
Second harmonic distortion		2fo			-35	dBc
Third harmonic distortion		3fo			-35	dBc
Noise power	$P_{out} = 34 \text{ dBm}$, RBW = 100 kHz $f = 925 \text{ to } 935 \text{ MHz}$ $f \geq 935 \text{ MHz}$			-73 -85	-70 -82	dBm dBm
Rise and fall time		t_r ; t_f			0.5	μs
Isolation between input and output	$P_{in} = 0 \text{ to } 10 \text{ dBm}$, $V_{CTL} \leq 0.2 \text{ V}$ (power down)		50			dB
Power Control						
Control-curve slope	$P_{out} \geq 25 \text{ dBm}$				150	dB/V
Power-control range	$V_{ctrl} = 0.3 \text{ to } 2.0 \text{ V}$		50			dB
Control-voltage range		V_{CTL}	0.3		2.0	V
Control current	$P_{in} = 0 \text{ to } 10 \text{ dBm}$, $V_{CTL} = 0 \text{ to } 2.0 \text{ V}$	I_{CTL}			200	μA

* With external matching, see application circuit

Application Circuit

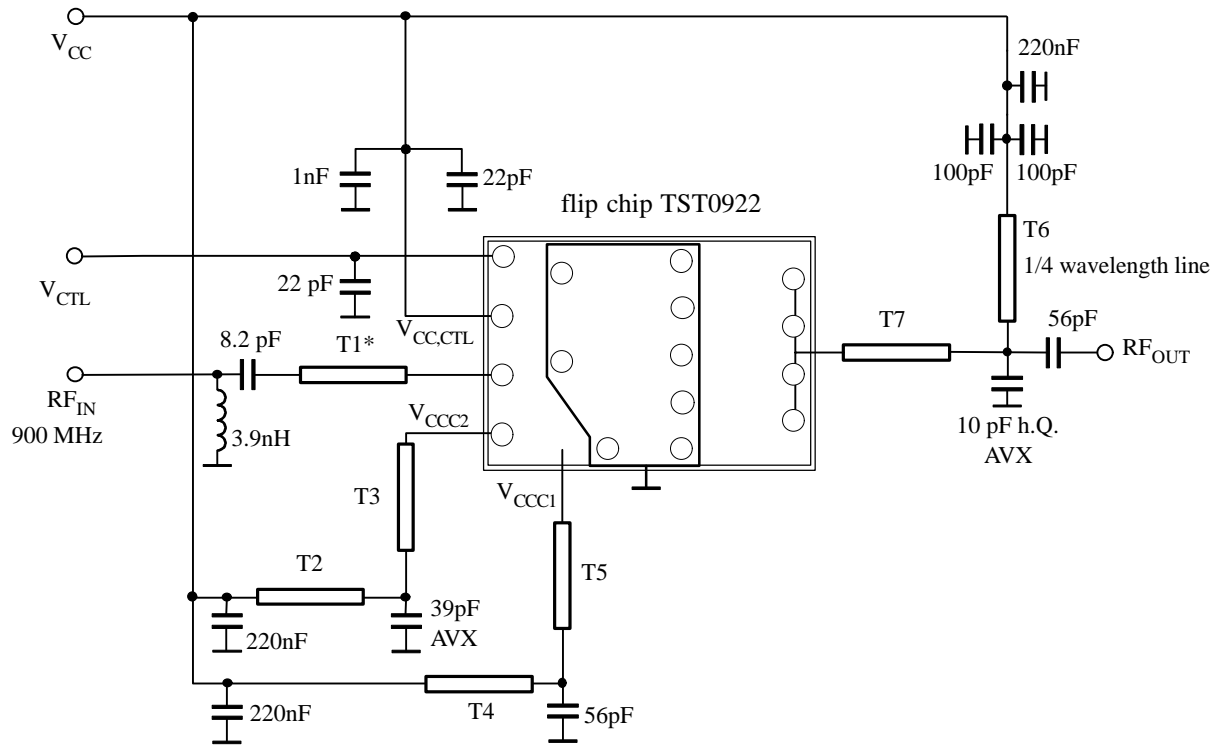

Microstrip line: FR4; Epsilon (r): 4.3; metal Cu: 3.5 μ m distance 1. layer – rf ground 0.5 mm

length (mm) \times width (mm)

T1: 2.08 \times 1 + 2.6 \times 0.25

T2: 4.6 \times 0.5

T3: 1.5 \times 0.25 + 0.93 \times 0.2

T4: 11.85 \times 1.0

T5: 6.7 \times 0.5 + 3.14 \times 0.25

T6: 68.06 \times 0.5

T7: 1.34 \times 0.27 + 5.74 \times 1.16

T...*: \rightarrow stripline can be reduced to minimum length

Figure 3. Application circuit

PCB Layout

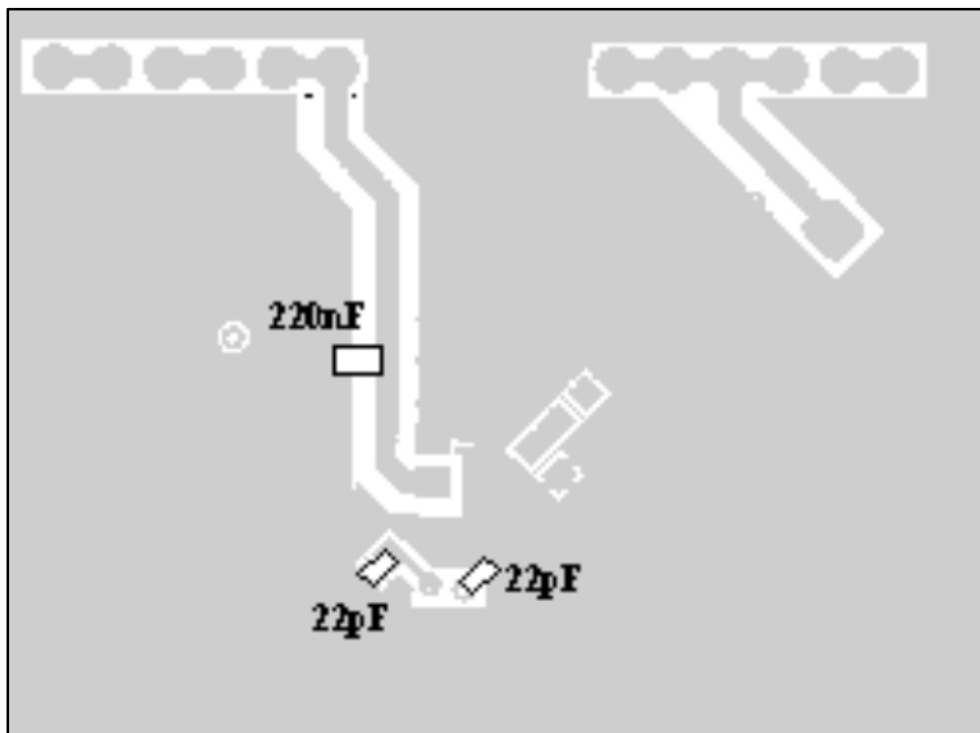
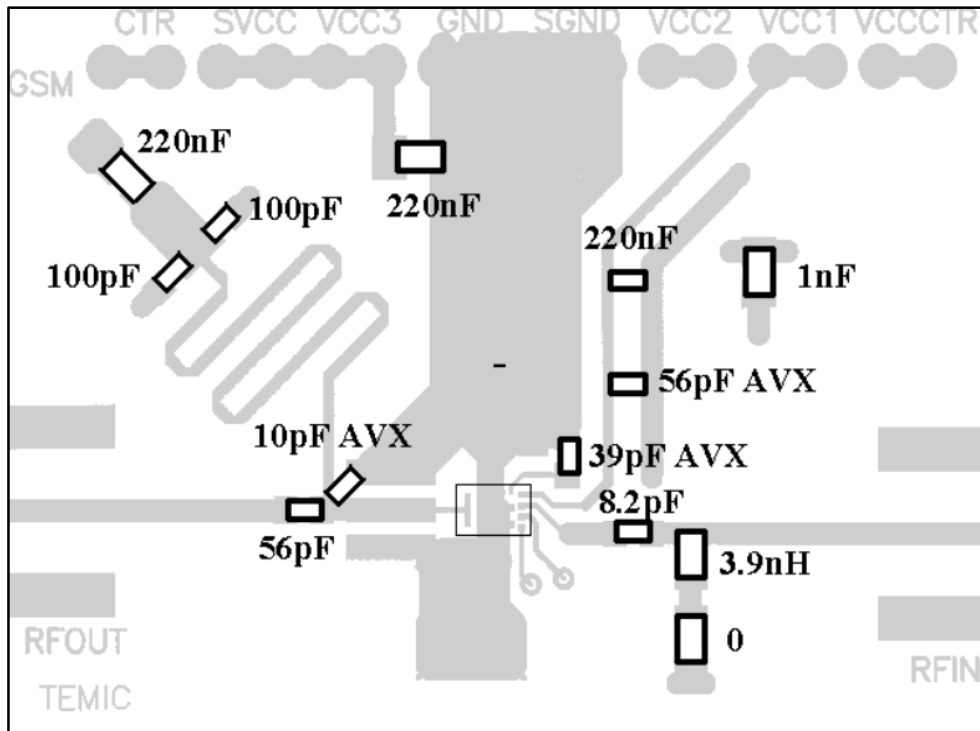
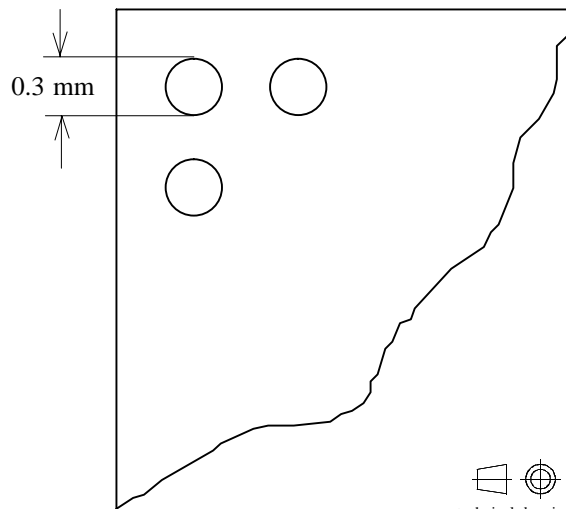

Figure 4. PCB layout

Package Information

Flipchip



technical drawings
according to DIN
specifications

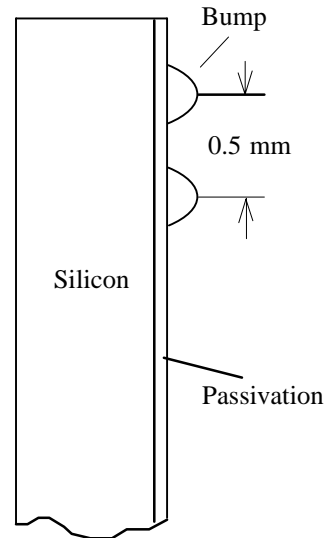

16526

Ozone Depleting Substances Policy Statement

It is the policy of **TEMIC Semiconductor GmbH** to

1. Meet all present and future national and international statutory requirements.
2. Regularly and continuously improve the performance of our products, processes, distribution and operating systems with respect to their impact on the health and safety of our employees and the public, as well as their impact on the environment.

It is particular concern to control or eliminate releases of those substances into the atmosphere which are known as ozone depleting substances (ODSs).

The Montreal Protocol (1987) and its London Amendments (1990) intend to severely restrict the use of ODSs and forbid their use within the next ten years. Various national and international initiatives are pressing for an earlier ban on these substances.

TEMIC Semiconductor GmbH has been able to use its policy of continuous improvements to eliminate the use of ODSs listed in the following documents.

1. Annex A, B and list of transitional substances of the Montreal Protocol and the London Amendments respectively
2. Class I and II ozone depleting substances in the Clean Air Act Amendments of 1990 by the Environmental Protection Agency (EPA) in the USA
3. Council Decision 88/540/EEC and 91/690/EEC Annex A, B and C (transitional substances) respectively.

TEMIC Semiconductor GmbH can certify that our semiconductors are not manufactured with ozone depleting substances and do not contain such substances.

We reserve the right to make changes to improve technical design and may do so without further notice.

Parameters can vary in different applications. All operating parameters must be validated for each customer application by the customer. Should the buyer use TEMIC Semiconductors products for any unintended or unauthorized application, the buyer shall indemnify TEMIC Semiconductors against all claims, costs, damages, and expenses, arising out of, directly or indirectly, any claim of personal damage, injury or death associated with such unintended or unauthorized use.

Data sheets can also be retrieved from the Internet: <http://www.temic-semi.com>

TEMIC Semiconductor GmbH, P.O.B. 3535, D-74025 Heilbronn, Germany
Telephone: 49 (0)7131 67 2594, Fax number: 49 (0)7131 67 2423