

The **DT-F** (Digital Transmission **F**) is a new screw-on 75 Ω coaxial connector series compatible with the existing F-type connectors which comply with the IEC 169-24 standard.

Designed according to this norm, **DT-F** series offers high reliability and enhanced performance up to 3 GHz, for digital applications like CATV, Internet, satellite, instrumentation and test equipment.

Most of **DT-F** connectors feature a **single piece design**, with its integrated center contact and crimp ferrule for **easy and low cost installation**.

ELECTRICAL CHARACTERISTICS

Impedance		75 Ω
Operating frequency		DC to 3 GHz
V.S.W.R. max		1.02 + 0.1 √F (F in GHz)
Max insertion loss	(dB)	0.085 √F (F in GHz)
Insulation resistance	(MΩ)	5000
Operating voltage	(VRMS)	500
Dielectric withstanding voltage	(VRMS)	1500

ENVIRONMENTAL CHARACTERISTICS

Temperature range		- 40°C to + 80°C
-------------------	--	------------------

MECHANICAL CHARACTERISTICS

Life		500 matings
Cable retention force	∅ 2.6 S ∅ 6 S + 7 S ∅ 10 S	40 N 80 N 100 N

MATERIALS

Body		Brass
Center contact	Male Female	Brass Beryllium copper
Insulator		Polypropylene

PLATING

Bodies		BBR (non magnetic alloy)
Center contact	Male Female	Silver Gold

INTERFACE

PLUG male contact

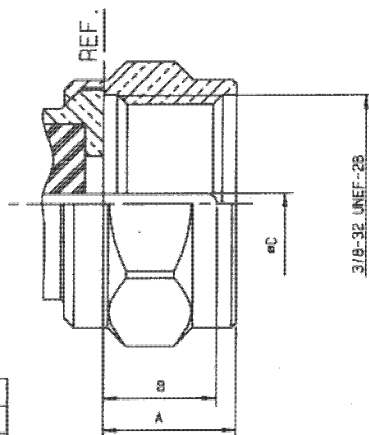

REF	MINI	MAXI
A		5.95
B	4.95	
∅C	0.88	0.92

JACK female contact

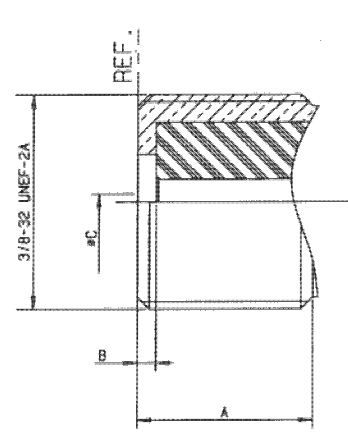

REF	MINI	MAXI
A	8.4	
B		0.9
∅C	Accepts pin diameter 0.8 to 1.2	

Standard packaging : 100 pieces. For unit packaging, add W after the part number.

All dimensions are given in mm.

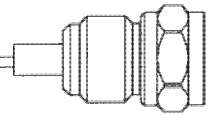

STRAIGHT PLUGS, CRIMP TYPE WITH CAPTIVE CENTER CONTACT

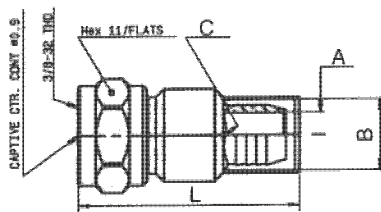
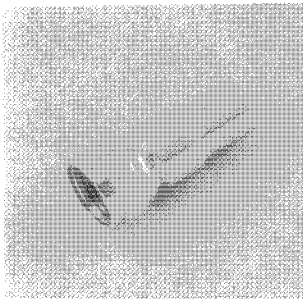

Cable group	Cable type	Part number	Accepts dielectric dia. A max	Length L	Rear socket accepts dia. C max	Dia. B
6/75/S	Belden 9104	R139 085 100	3.85	24.2	0.8 to 1.2	7.8
7/75/S	Belden 9116	R139 087 000	4.85			
10/75/S	Belden 9064	R139 089 000	7.45	26	1.2 to 1.65	11.95

BULKHEAD STRAIGHT PLUG, CRIMP TYPE WITH SEPARATED CENTER CONTACT

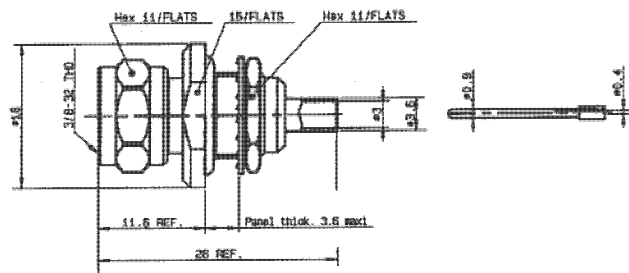
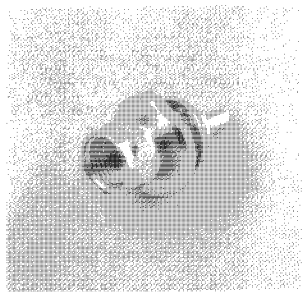

Panel piercing

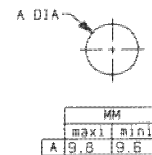

Cable group	Cable type	Part number	Captive center contact
2.6/75/S	RG 179 - RG 187	R139 076 100	NO

STRAIGHT PLUG, CRIMP TYPE WITH SEPARATED CENTER CONTACT

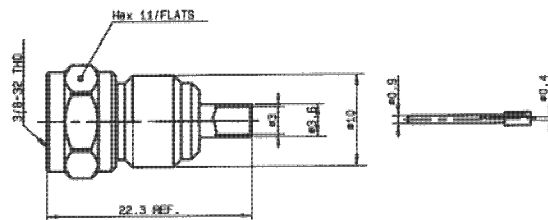
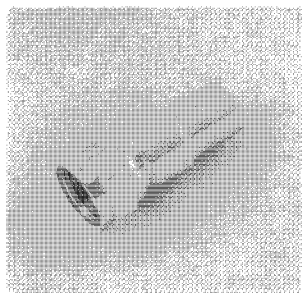

Cable group	Cable type	Part number	Captive center contact
2.6/75/S	RG 179 - RG 187	R139 077 000	NO

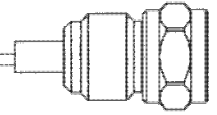

STRAIGHT BULKHEAD JACK, WITH SEPARATED CENTER CONTACT

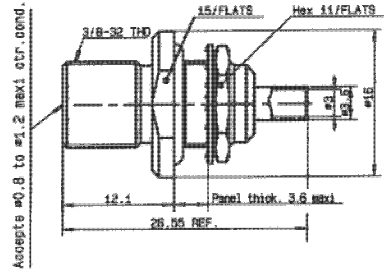
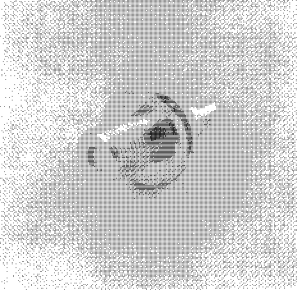

Panel piercing

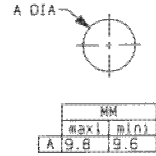

Cable group	Cable type	Part number	Captive center contact
2.6/75/S	RG 179 - RG 187	R139 331 100	YES

STRAIGHT BULKHEAD RECEPTACLE

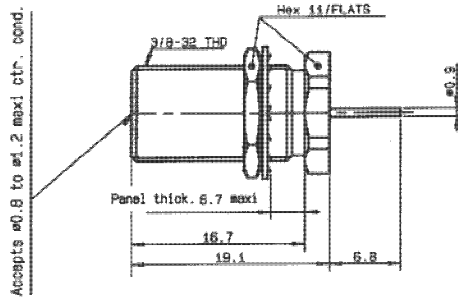
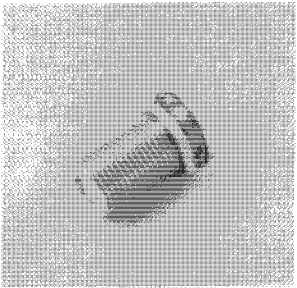

Panel piercing

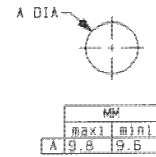

Part number	Captive center contact
R139 553 200	YES

STRAIGHT SCREW RECEPTACLE

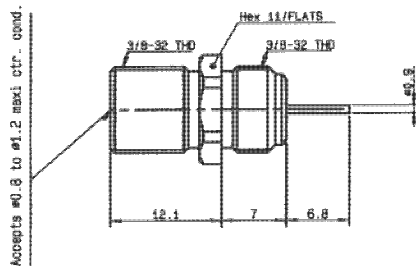
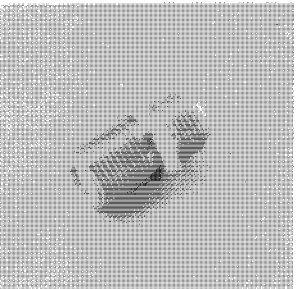

Part number	Captive center contact
R139 555 200	YES

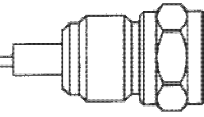

CRIMPING TOOL FOR CENTER CONTACTS

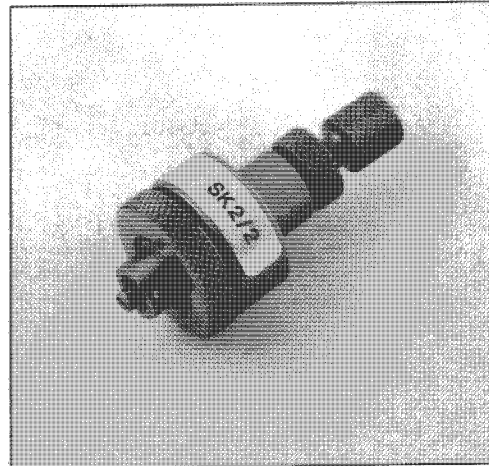
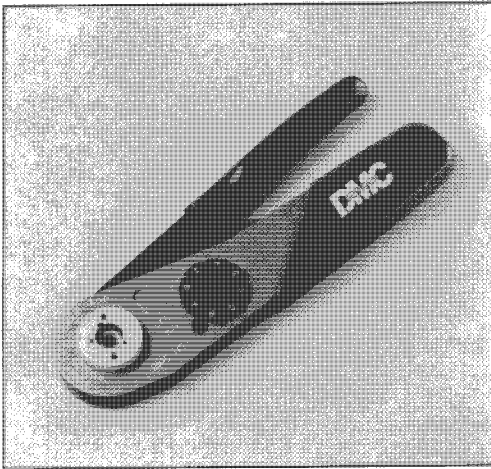

Cable group	Crimp tool	Positioner
2.6/75/S	R282 281 000 (M22520/2-01)	R282 967 500 (4 x 2 pts)

CRIMPING TOOL FOR BODIES

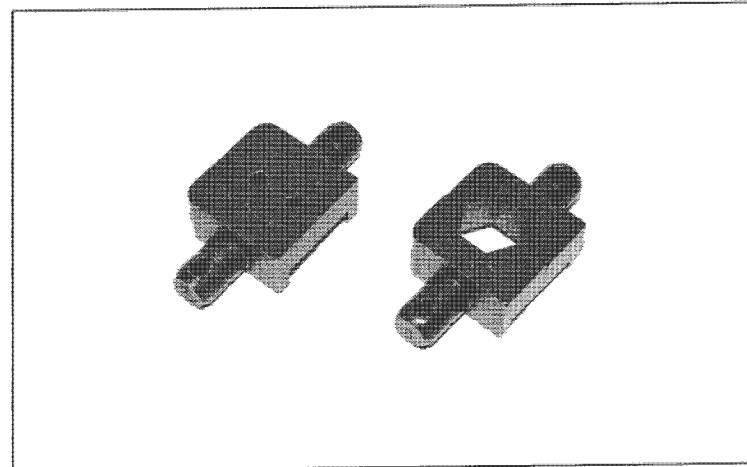

Cable group	Standard crimp tool P/N (Dies included)	MIL crimp tool R282 293 000 (M22520/5-01) Dies P/N	Dies size (Hex.)
2.6/75/S	R282 211 000	R282 235 003 (M22520/5-03)	3.25
6 and 7/75/S		R282 235 041 (M22520/5-41)	7.37
10/75/S		R282 235 021 (M22520/5-21)	12.06