

High Stability Temperature Compensated Crystal Oscillator (TCXO)  
 Supports  $\pm 0.1 \times 10^{-6}$  over -40 °C to 105 °C



## TG7050CMN / TG7050SMN

### Key Specifications

Frequency Range: 10 MHz to 54 MHz  
 Supply Voltage: 3.3 V Typ.  
 Operation Temperature: -40 to +105 °C  
 Freq. / Temp characteristic:  $\pm 0.1 \times 10^{-6}$  Max. over temperature  
 Frequency Slope:  $\pm 0.05 \times 10^{-6} / ^\circ\text{C}$  Max. over temperature  
 Frequency Aging:  $\pm 3.0 \times 10^{-6}$  Max. / 20 years (meets Stratum3)  
 Package:  $7.0 \times 5.0 \times 1.5$  mm (4 pins)  
 With on-chip filter capacitor for lower phase noise



TG7050CMN  
 TG7050SMN  
 (4 pins)

**Description** - TG7050CMN and TG7050SMN is a high stability TCXO available with either CMOS or Clipped Sine output

- Specified to +105 °C for 5G Base Stations and Edge Computing needs outdoor installation, miniaturization, and fan-less operation
- Compared to other TCXOs it offers a variety of improvements such as low temperature slope and phase noise
- Complies with GR-1244-CORE Stratum3 and G.8262.1, G.8273.2 (Class A, B)
- Note: this product does not have a voltage control (Vc) function

### Applications

- Network equipment
- Base station
  - Microwave
- Sync compliance standards
- Stratum3
  - SyncE
  - IEEE1588

### Outline dimensions

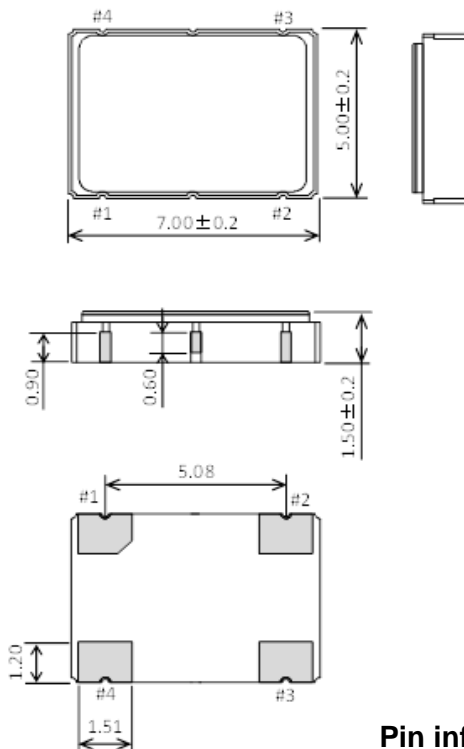

### Pin information

Pin #	Connection
1	N.C.
2	GND
3	OUT
4	Vcc

### Characteristics

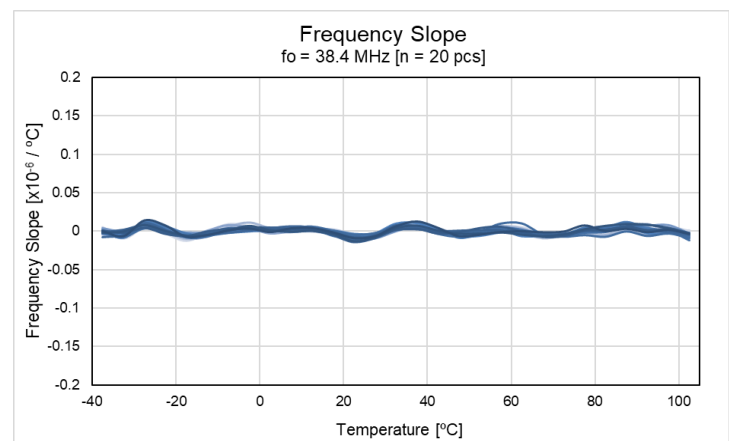
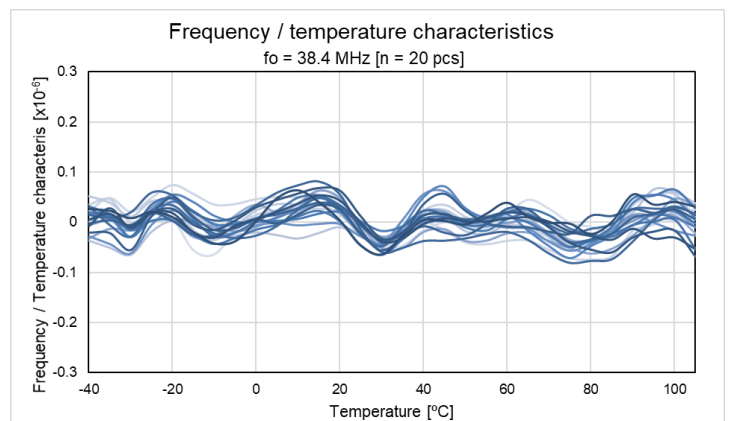

## [ 1 ] Product Number / Product Name

## (1) Product Name

TG7050 C M N 30.720000MHz    C   A   H   N   G   A  
 ①    ②③                    ④                    ⑤   ⑥   ⑦   ⑧   ⑨   ⑩

- ①Model ②Output (C: CMOS, S: Clipped sine wave) ③Package type (M: 4 pins) ④Frequency ⑤Supply voltage (C: 3.3 V Typ.)  
 ⑥Frequency/temperature characteristics (A:  $\pm 0.1 \times 10^{-6}$  Max.) ⑦Operating temperature (H: -40 °C to +105 °C)  
 ⑧OE function (H: Active High, N: Non) ⑨Vc function (G: Vc Non) ⑩Internal identification code ("A" is default)

## (2) Product Number / Ordering Code

TG7050CMN: X1G005681xxxx14 (CMOS output)

TG7050SMN: X1G005691xxxx14 (Clipped sine wave)

\* Please contact Epson for detail of product number

## [ 2 ] Absolute Maximum Ratings

Parameter	Symbol	Specifications			Unit	Conditions
		Min.	Typ.	Max.		
Supply voltage	V <sub>CC-GND</sub>	-0.5	-	+4.0	V	
Storage temperature range	T <sub>stg</sub>	-40	-	+105	°C	Storage as single product

## [ 3 ] Operating Conditions

Parameter	Symbol	Specifications			Unit	Conditions
		Min.	Typ.	Max.		
Supply voltage	V <sub>CC</sub>	3.135	3.3	3.465	V	V <sub>CC</sub> = 3.3 V ± 5 %
Supply voltage	GND	0	-	0	V	
Operating temperature range	T <sub>use</sub>	-40	+25	+85	°C	105 °C Max. (Option)
Output load (CMOS)	Load <sub>C</sub>	13.5	15	16.5	pF	
Output load (Clipped sine)	Load <sub>R</sub>	9	10	11	kΩ	
Output load (Clipped sine)	Load <sub>C</sub>	9	10	11	pF	
Output load (Clipped sine)	C <sub>c</sub>	0.01	-	-	μF	AC coupling capacitor *

\* AC coupling capacitor is not included in this TCXO, please attach an external AC coupling capacitor to the out pin.

## [ 4 ] Frequency Characteristics

(V<sub>CC</sub> = 3.3 V, GND = 0.0 V, T<sub>use</sub> = +25°C)

Parameter	Symbol	Specifications			Unit	Conditions
		Min.	Typ.	Max.		
Output Frequency	f <sub>o</sub>	10	-	54	MHz	Standard frequency
		19.2, 38.4, 38.88				
Frequency tolerance *1	f <sub>tol</sub>	-1.0	-	+1.0	x10 <sup>-6</sup>	T <sub>use</sub> = +25 °C ± 2 °C After 3 reflows *2
Frequency / temperature characteristics	f <sub>o-Tc</sub>	-0.1	-	0.1	x10 <sup>-6</sup>	T <sub>use</sub> = -40 °C to +85 °C, Reference to (f <sub>max</sub> +f <sub>min</sub> ) / 2
Frequency slope	f <sub>slp</sub>	-0.05	-	0.05	x10 <sup>-6</sup> / °C	T <sub>use</sub> = -40 °C to +85 °C, One frequency reading every 5 °C Min.
Frequency / load coefficient	f <sub>o-Load</sub>	-0.1	-	+0.1	x10 <sup>-6</sup>	Load <sub>R</sub> // Load <sub>C</sub> ± 10 %
Frequency / voltage coefficient	f <sub>o-V<sub>CC</sub></sub>	-0.1	-	+0.1	x10 <sup>-6</sup>	V <sub>CC</sub> = 3.3 V ± 5 %
Frequency aging *3	f <sub>age</sub>	-0.5	-	+0.5	x10 <sup>-6</sup>	T <sub>use</sub> = +25 °C, 1 year
Frequency aging *3	f <sub>age</sub>	-3.0	-	+3.0	x10 <sup>-6</sup>	T <sub>use</sub> = +25 °C, 20 years
Holdover stability (Free-run accuracy) *4	f <sub>hos</sub>	-4.6	-	+4.6	x10 <sup>-6</sup>	T <sub>use</sub> = +25 °C, 20 years

\*1 Include initial frequency tolerance and frequency deviation after reflow cycles.

\*2 Measured 24 hours after reflow soldering.

\*3 Aging is estimated from environmental reliability tests and the expected amount of frequency variation over time. It is not intended as a guarantee of performance over the product-life cycle.

\*4 This includes initial frequency tolerance, frequency / temperature characteristics, frequency / load coefficient, frequency/voltage coefficient and frequency aging (+25 °C, 20 years) .

## [ 5 ] Electrical Characteristics

(V<sub>CC</sub>= 3.135 V to 3.465 V, GND = 0.0 V, T<sub>use</sub> = +25 °C)

Parameter	Symbol	Specifications			Unit	Conditions
		Min.	Typ.	Max.		
Current consumption (CMOS)	I <sub>CC</sub>	-	-	7 9 10	mA	10 MHz ≤ f <sub>o</sub> ≤ 26 MHz 26 MHz < f <sub>o</sub> ≤ 40 MHz 40 MHz < f <sub>o</sub> ≤ 54 MHz
Current consumption (Clipped sine)	I <sub>CC</sub>	-	-	6	mA	
Output voltage (CMOS)	V <sub>OH</sub>	90 % V <sub>CC</sub>	-	-	V	
Output voltage (CMOS)	V <sub>OL</sub>	-	-	10 % V <sub>CC</sub>	V	
Output voltage (Clipped sine)	V <sub>pp</sub>	0.8	-	-	V	Peak to peak voltage
Rise time (CMOS)	t <sub>r</sub>	-	-	8	ns	10 % V <sub>CC</sub> to 90 % V <sub>CC</sub> level
Fall time (CMOS)	t <sub>f</sub>	-	-	8	ns	90 % V <sub>CC</sub> to 10 % V <sub>CC</sub> level
Start-up time	t <sub>str</sub>	-	-	5	ms	Until output signal has been reached min 90 % of final amp.
Symmetry (CMOS)	SYM	45	50	55	%	50 % V <sub>CC</sub> Level
Phase noise (f <sub>o</sub> = 38.88 MHz) *	L(f)	-	-61	-	dBc/Hz	1 Hz offset
		-	-95	-		10 Hz offset
		-	-121	-		100 Hz offset
		-	-141	-		1 kHz offset
		-	-151	-		10 kHz offset
		-	-156	-		100 kHz offset
		-	-158	-		1 MHz offset

\* For other frequencies, please refer to Charts (7-10), Phase noise

## [ 6 ] Test Circuit: CMOS-Output

## 1) Output Waveform

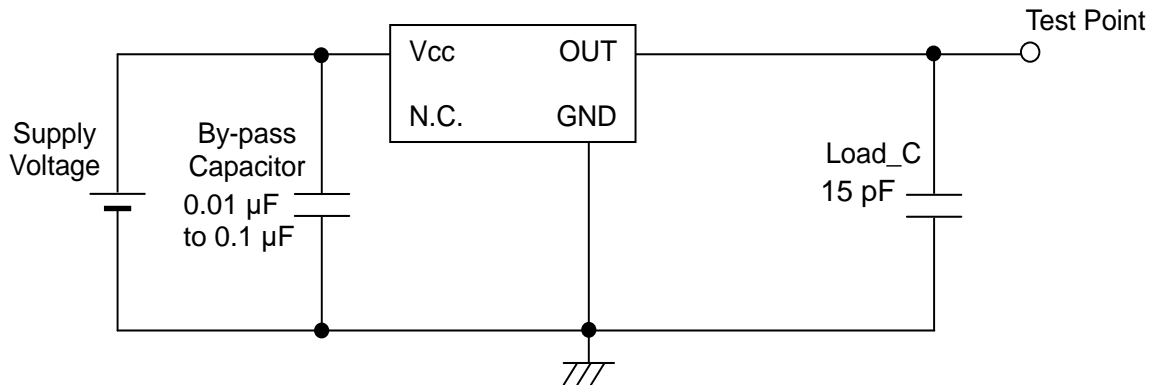

## 2) Current Consumption

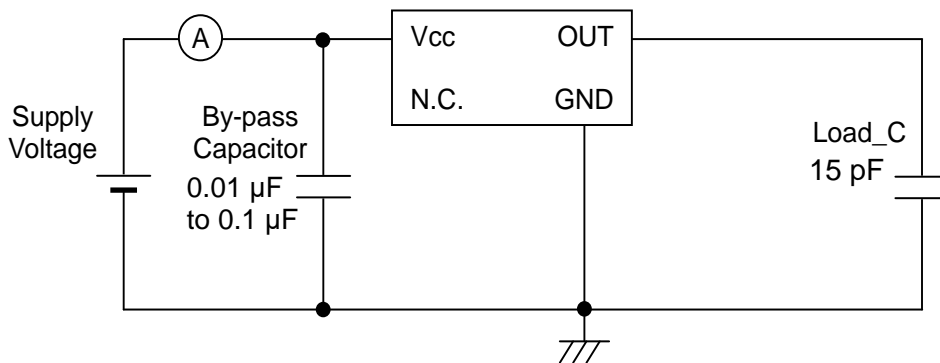

## 3) Conditions

1. Oscilloscope: Impedance Min. 1 MΩ  
Input capacitance Max. 10 pF  
Band width Min. 300 MHz
2. Load\_C includes probe capacitance
3. A capacitor (By-pass: 0.01 μF to 0.1 μF) is placed between V<sub>CC</sub> and GND, and closely to TCXO
4. Use the current meter whose internal impedance value is small.
5. Power supply connections should be as low impedance as possible
6. GND pin should be connected to low impedance GND

## [ 6 ] Test Circuit: Clipped Sine Wave-Output

## 1) Output Waveform

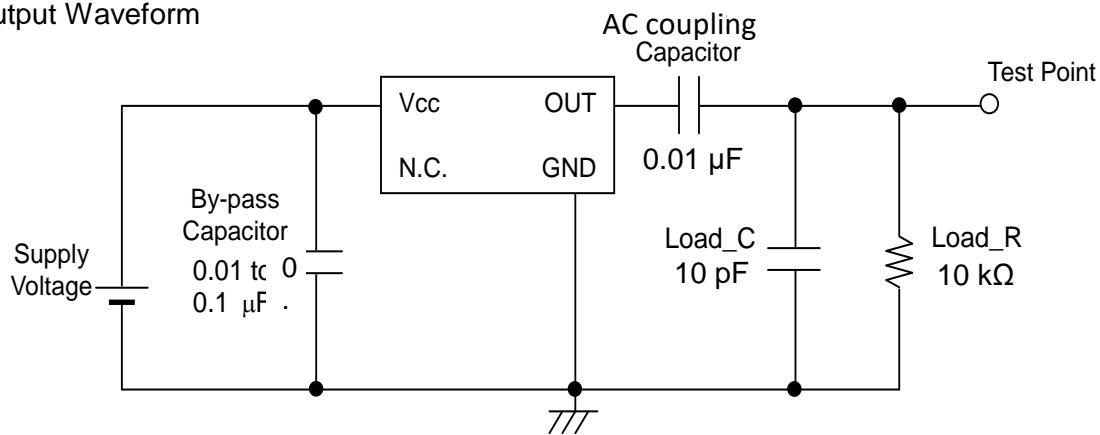

## 2) Current Consumption

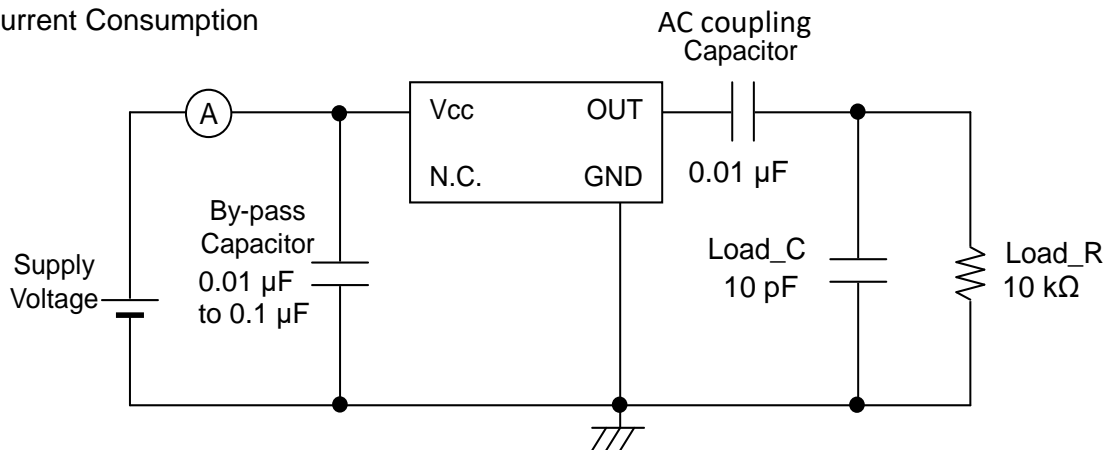

## 3) Conditions

1. Oscilloscope: Impedance Min.  $1\text{M}\Omega$   
Input capacitance Max.  $10\text{ pF}$   
Band width Min.  $300\text{ MHz}$
2. Load\_C includes probe capacitance
3. A capacitor (By-pass:  $0.01\text{ }\mu\text{F}$  to  $0.1\text{ }\mu\text{F}$ ) is placed between  $V_{CC}$  and GND, and closely to TCXO
4. Use the current meter whose internal impedance value is small.
5. Power supply connections should be as low impedance as possible
6. GND pin should be connected to low impedance GND

## [ 7 ] Characteristic Data

## (7-1) Frequency / Temperature Characteristics &amp; Frequency Slope

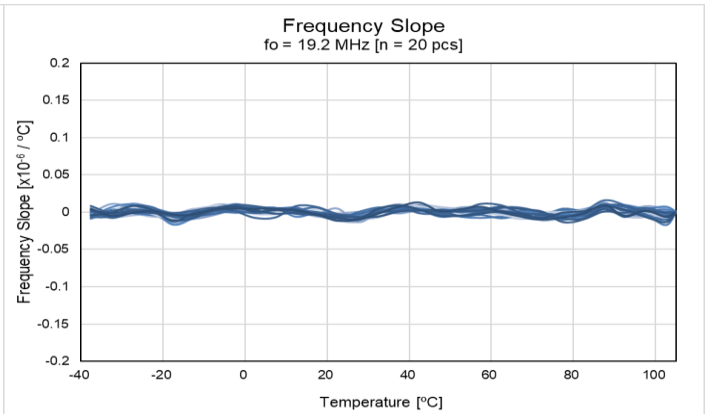
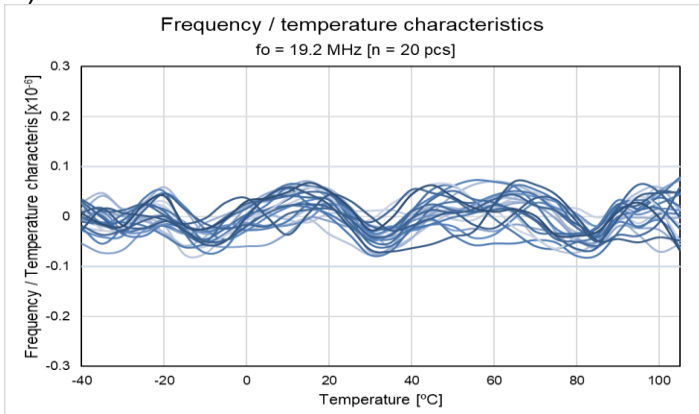
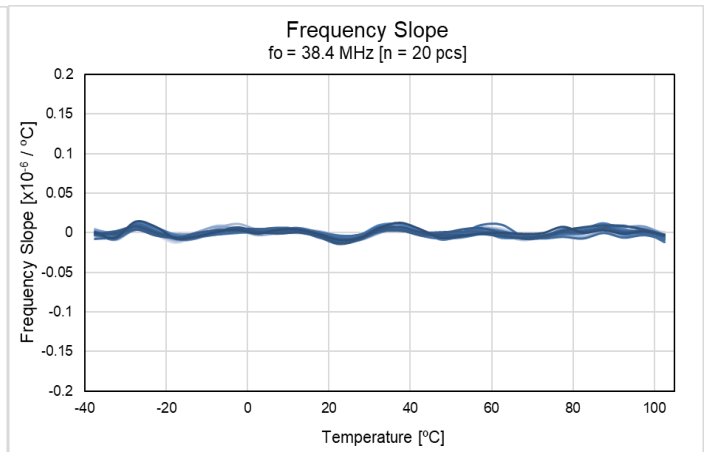
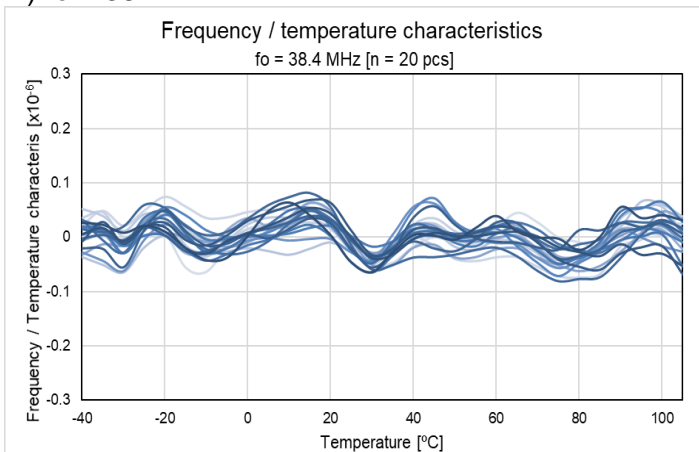
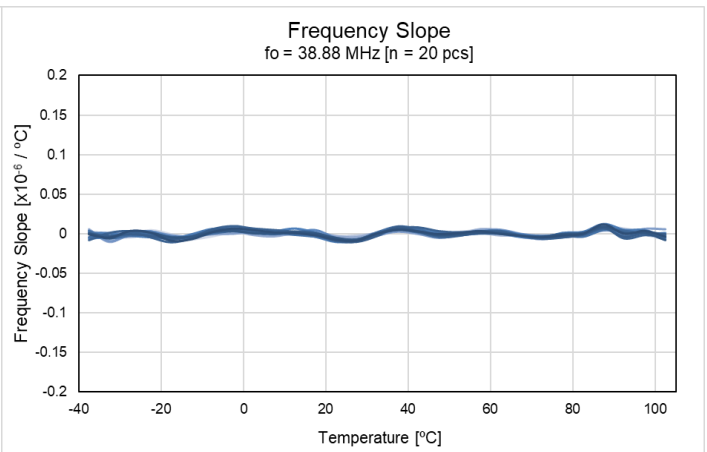
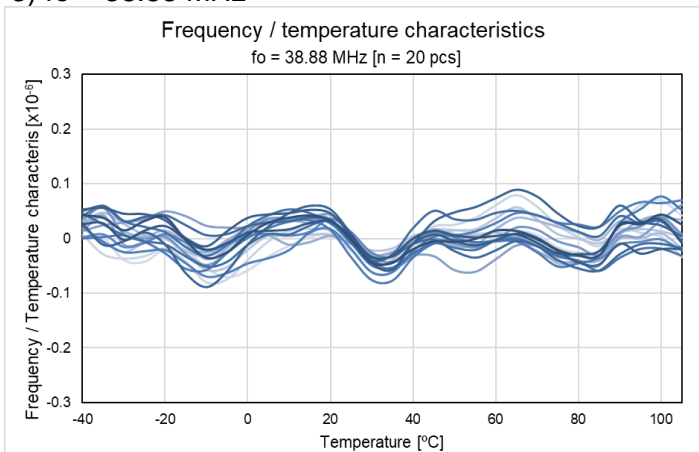
1)  $f_0 = 19.2$  MHz2)  $f_0 = 38.4$  MHz3)  $f_0 = 38.88$  MHz

(7-2) Frequency / Voltage Coefficient

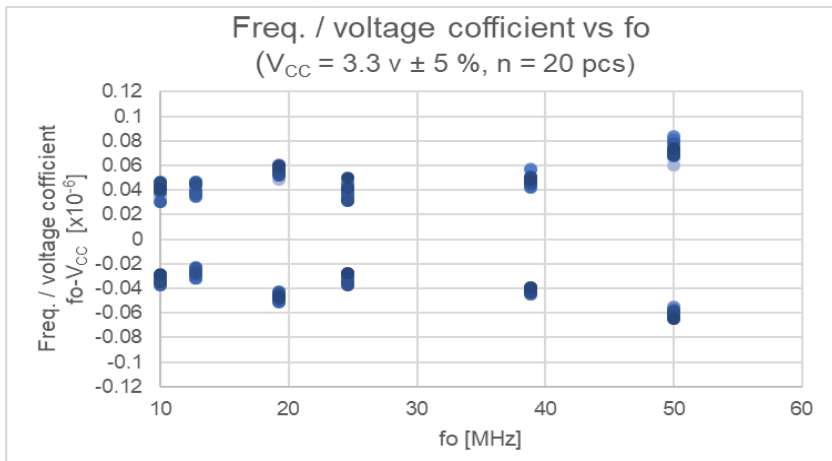

(7-3) Frequency Aging Conversion

\* Aging stability is estimated from environmental reliability tests and the expected amount of frequency variation of the product.  
It is not intended as a guarantee of performance over the product-life cycle.

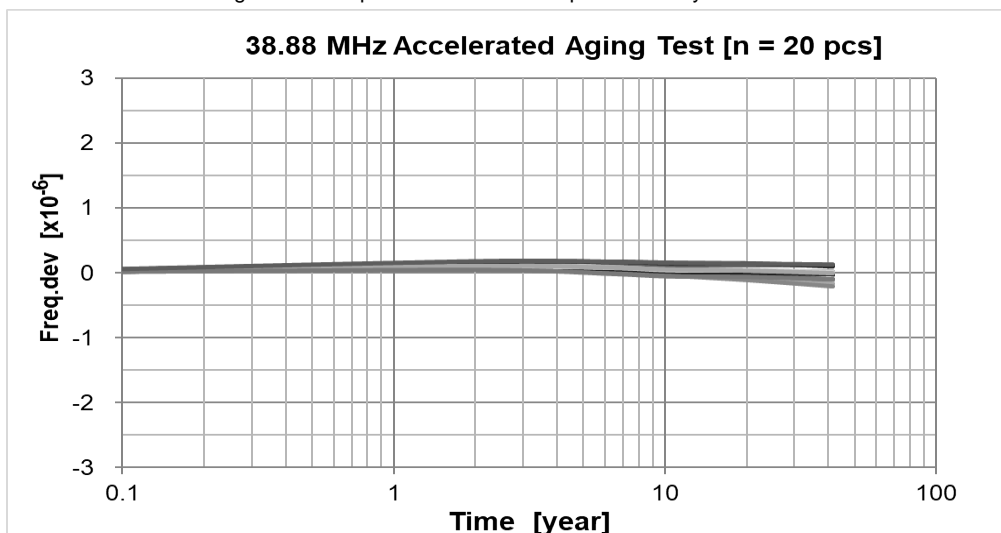

(7-4) ホールドオーバー特性

1) After 10 days

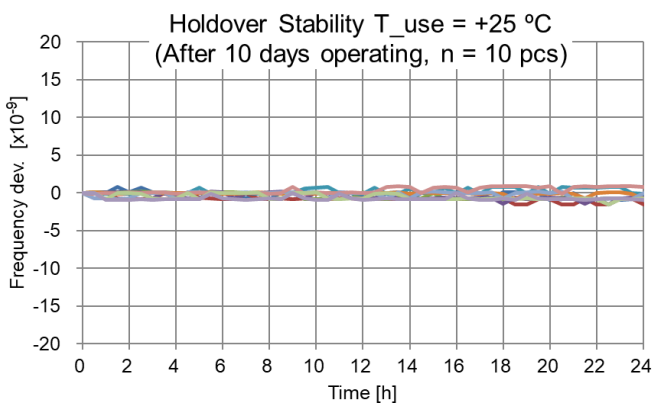

2) After 48 hours

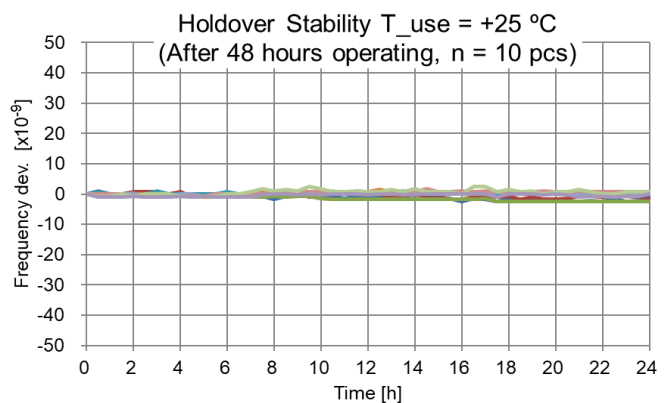

(7-5) G-Sensitivity

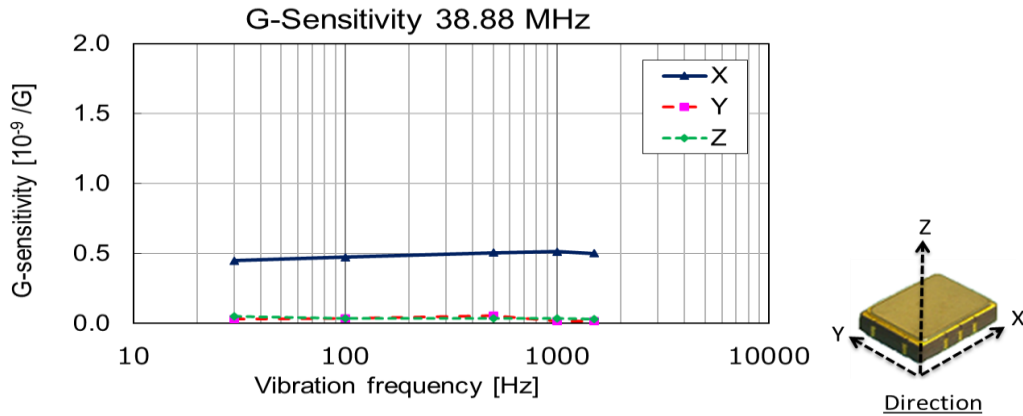

(7-6) Current Consumption (CMOS output)

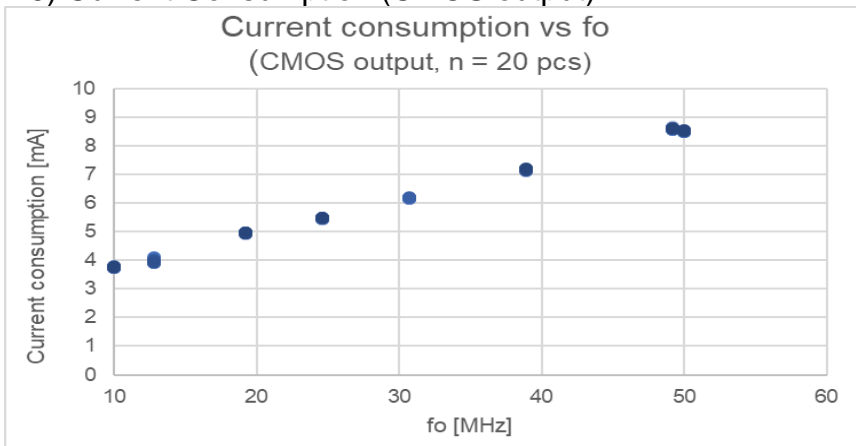

(7-7) Rise Time / Fall Time (CMOS output)

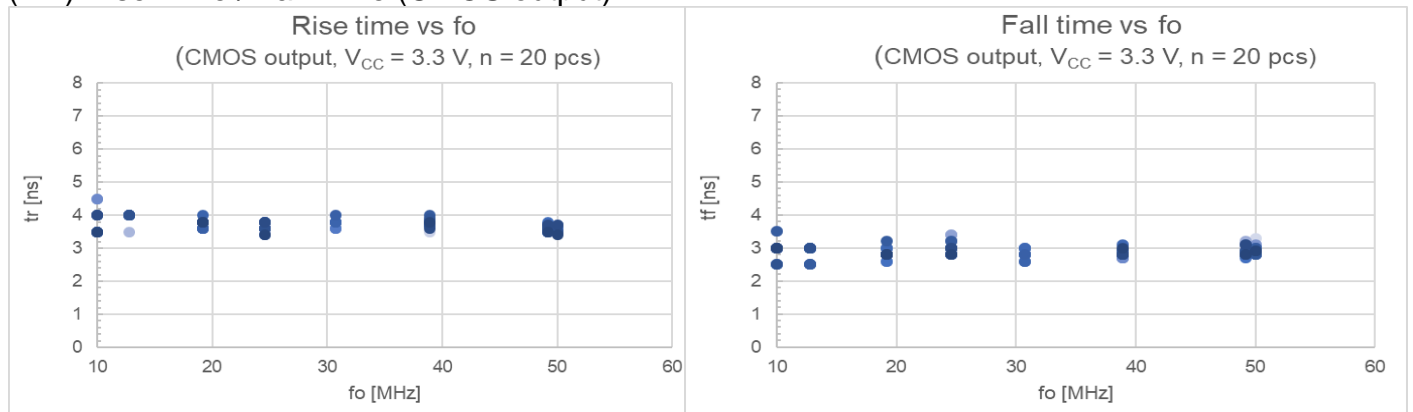

(7-8) Output Voltage [V<sub>OH</sub>, V<sub>OL</sub>] (CMOS output)

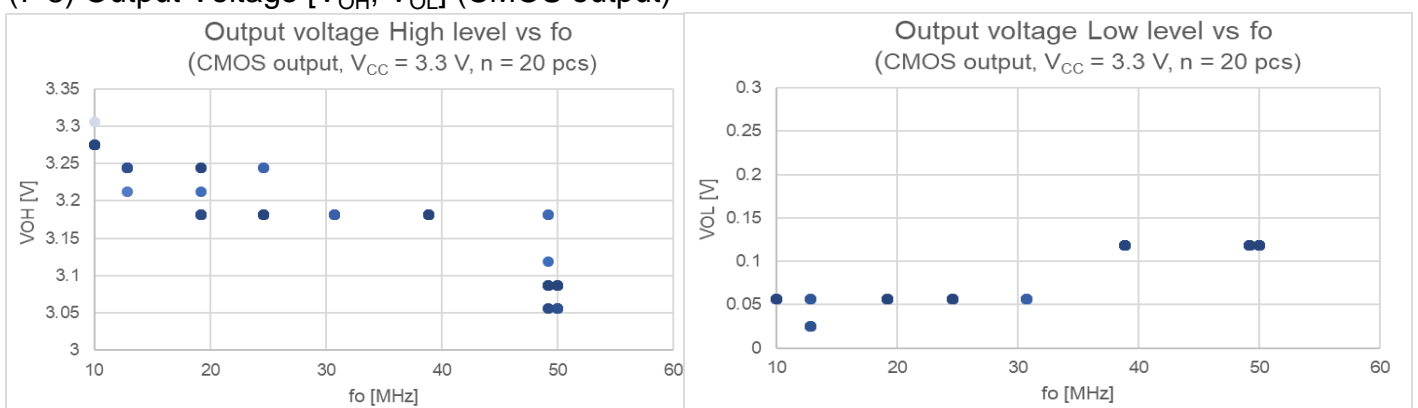

(7-9) Symmetry (CMOS output)

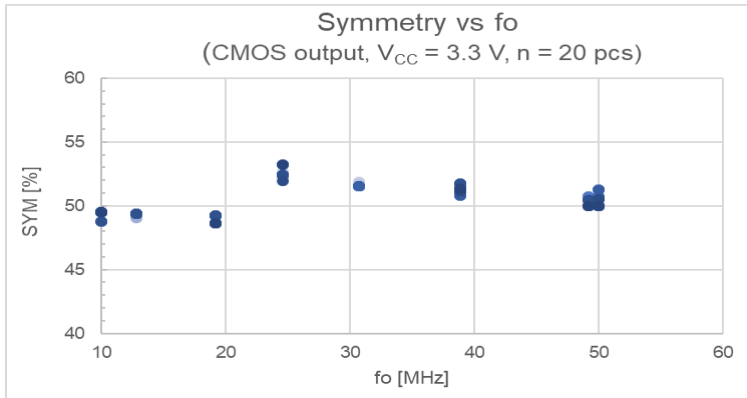

(7-10) Phase Noise

1) fo = 19.2 MHz

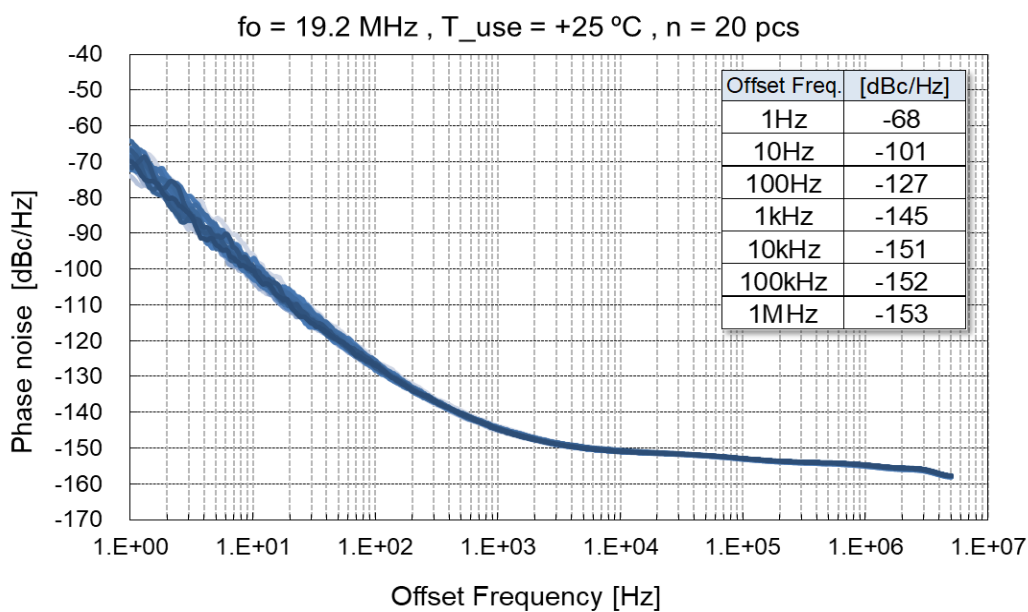

2) fo = 38.88 MHz

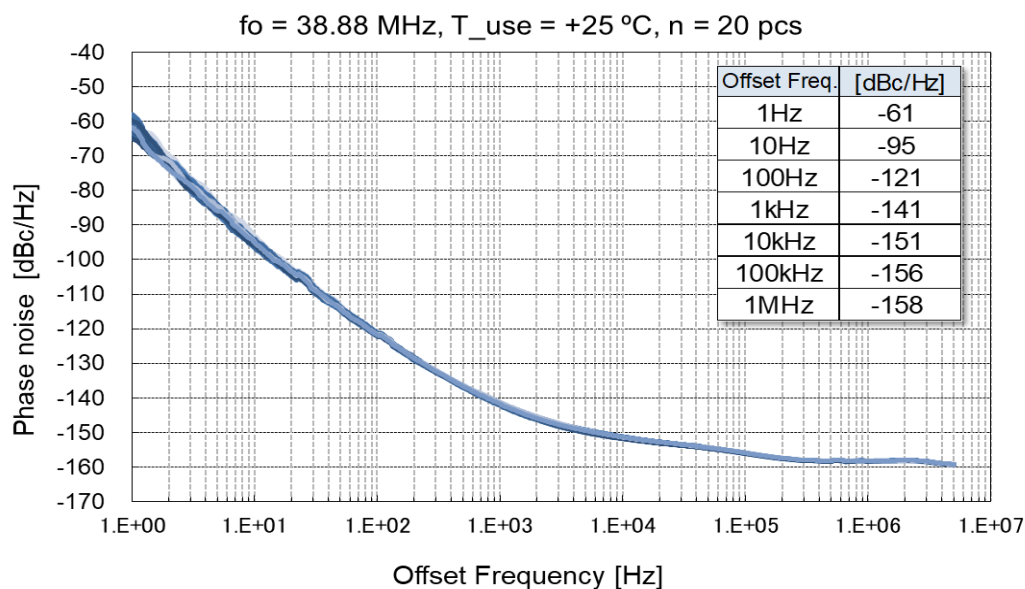

(7-11) Short Term Stability

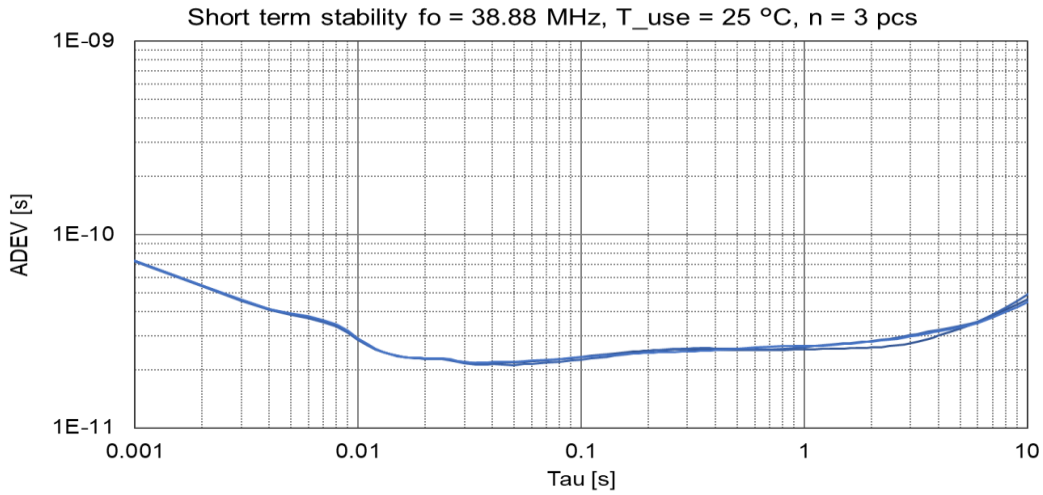

(7-12) Wander

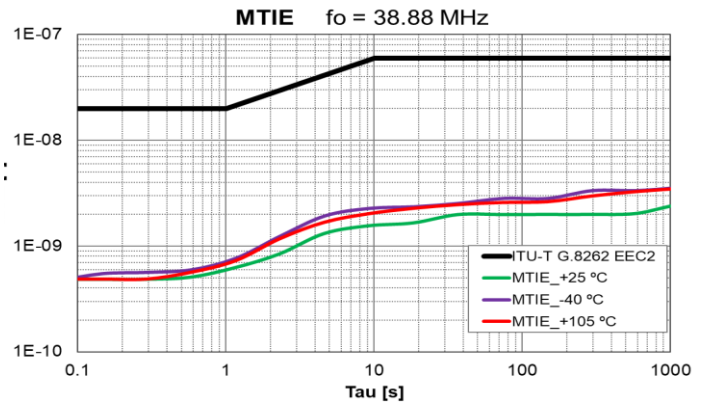
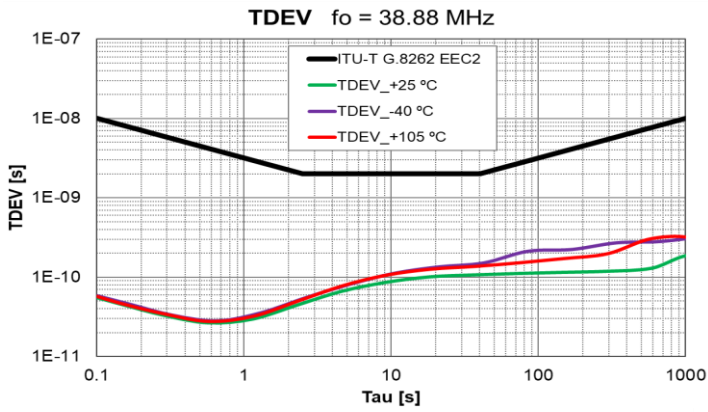

[ 8 ] Outline Drawing unit: mm

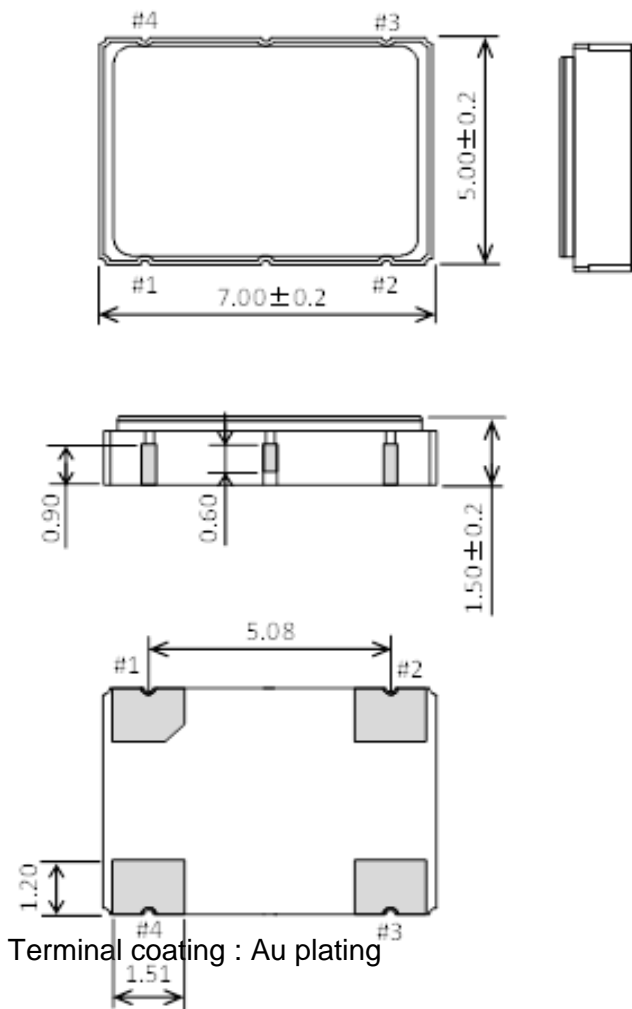

[ 9 ] Recommended Foot Print unit: mm

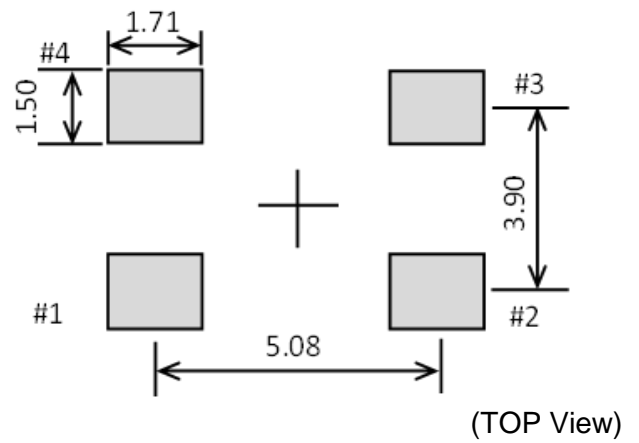

Pin #	Connection
1	N.C.
2	GND
3	OUT
4	V <sub>CC</sub>

Do not connect pins marked as "N.C." with to any other pin including those marked "N.C."

For proper operation, connect a 0.01 μF to 0.1 μF by-pass capacitor between V<sub>CC</sub> - GND as near as possible to the power source terminal of the oscillator

Marking

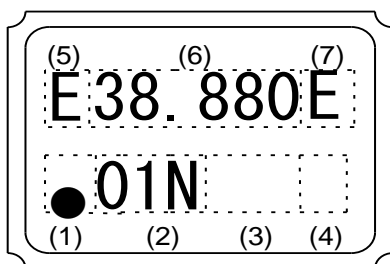

- (1) Pin 1 identifier
- (2) TCXO model ID [01N] is sample code
- (3) TCXO Lot No. (3 digits)
- (4) Location code
- (5) Epson logo Mark [E]
- (6) Frequency data
- (7) TG7050CMN code : E  
TG7050SMN code : F  
TG-5511CA code : K

## [ 9 ] Moisture Sensitivity Level , Electro-Static Discharge

## (1)Moisture Sensitivity Level (MSL)

Parameter	Specifications	Conditions
MSL	LEVEL1	JEDEC J-STD-020D

## (2)Electro-Static Discharge (ESD)

Parameter	Specifications	Conditions
Human Body Model (HBM)	2 000 V Min.	IEC 60749-26 Ed.2.0:2006(b), 100 pF, 1.5 kΩ, 3 times
Machine Model (MM)	200 V Min.	IEC 60749-27 Ed.2.0:2006(b), 200 pF, 0 Ω, 1 time

## [ 10 ] Reflow Profile (follow to IPC / JEDEC J-STD-020D.1)

Temperature [ °C ]

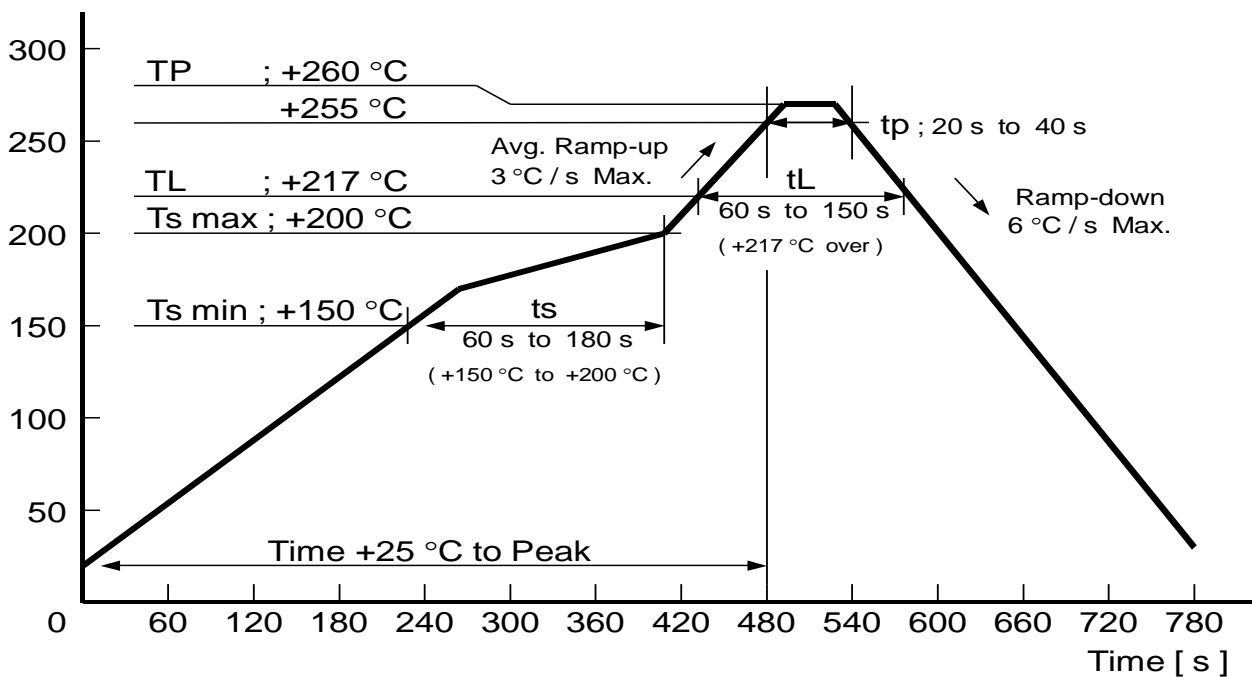

[ 11 ] Packing Information

(1) Quantity

For this product series, the standard for the last two digits of the product number is "14", 1 000 pcs/Reel.

TG7050CKN: X1G005661xxxx14  
 TG7050SKN: X1G005671xxxx14  
 TG7050CMN: X1G005681xxxx14  
 TG7050SMN: X1G005691xxxx14

TG-5510CA: X1G006001xxxx14  
 TG-5511CA: X1G006011xxxx14

(2) Taping Specification

Subject to EIA-481, IEC-60286 and JIS C0806

1) Tape dimensions TE-1612L

Carrier Tape Material: PS (Polystyrene)

Top Tape Material: PET (Polyethylene Terephthalate) + PE (Polyethylene)

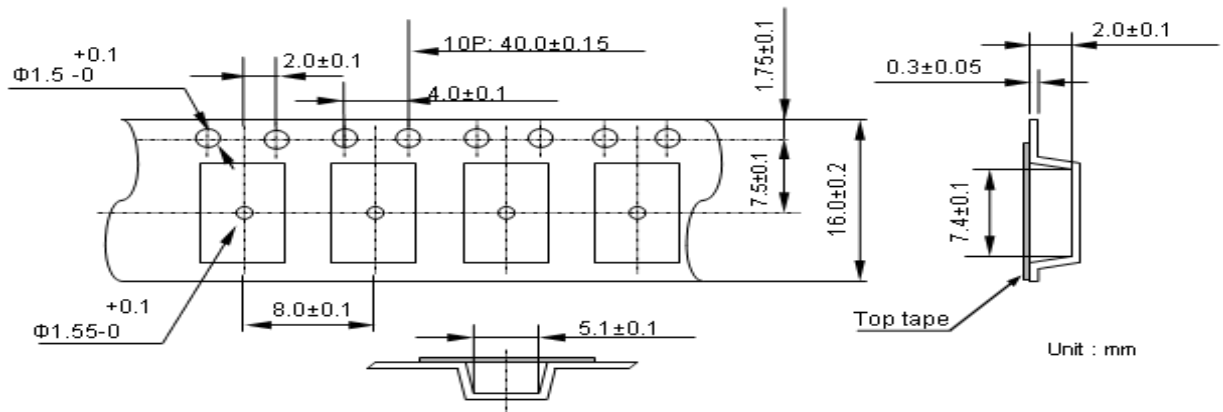

2) Reel dimensions

Center Material: PS (Polystyrene)

Reel Material: PS (Polystyrene)

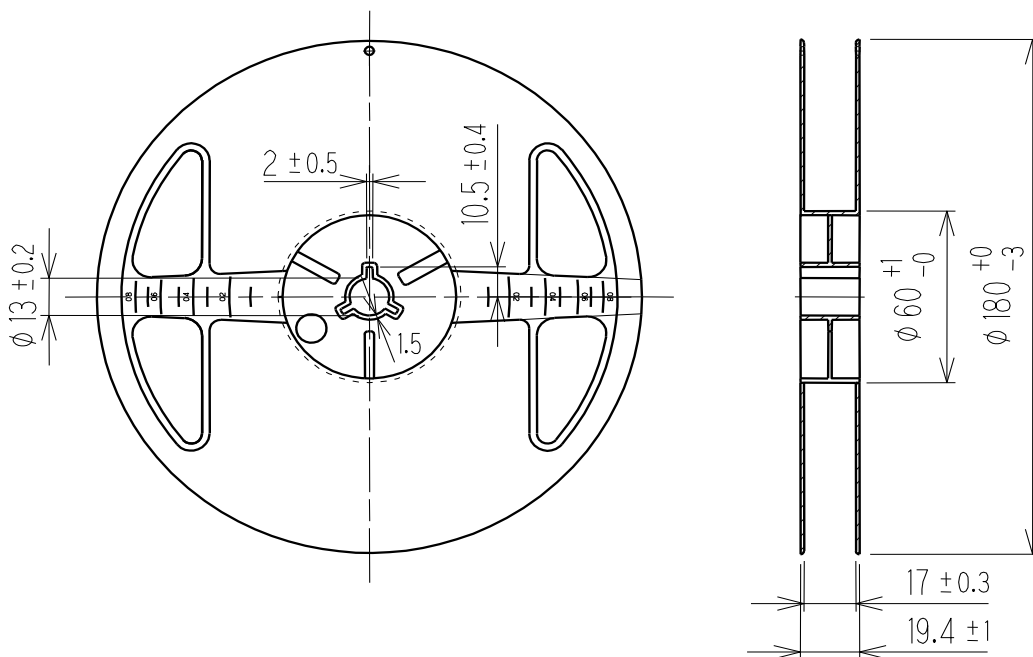

## [ 12 ] Handling Precautions

Prior to using this product, please carefully read the section entitled "Precautions" on our Web site (<https://www5.epsondevice.com/en/information/#precaution>) for instructions on how to handle and use the product properly to ensure optimal performance of the product in your equipment.

Before using the product under any conditions other than those specified therein, please consult with us to verify and confirm that the performance of the product will not be negatively affected by use under such conditions.

In addition to the foregoing precautions, in order to avoid the deteriorating performance of the product, we strongly recommend that you DO NOT use the product under ANY of the following conditions:

- (1) Do not expose this product to excessive mechanical shock or vibration.
- (2) This product can be damaged by mechanical shock during the soldering process depending on the equipment used, process conditions, and any impact forces experienced. Always follow appropriate procedures, particularly when changing the assembly process in any way and be sure to follow applicable process qualification standards before starting production.
- (3) These devices are sensitive to ESD, use appropriate precautions during handling, assembly, test, shipment, and installation.
- (4) This product contains semiconductor content that should not be exposed to electromagnetic waves.
- (5) The use of ultrasonic technology for cleaning, bonding, etc. can damage the Xtal unit inside this product. Please carefully check for this consideration before using ultrasonic equipment for volume production with this product.
- (6) Noise and ripple on the power supply may have undesirable effects on operation and cause degradation of phase noise characteristics. Evaluate the operation of this device with appropriate power supplies carefully before use.
- (7) When applying power, ensure that the supply voltage increases monotonically for proper operation. On power done, do not reapply power until the supplies, bypass capacitors, and any bulk capacitors are completely discharged since that may cause the unit to malfunction.
- (8) Aging specifications are estimated from environmental reliability tests and expected frequency variation over time. They do not provide a guarantee of aging over the product lifecycle.
- (9) The metal cap on top of the device is directly connected to the GND terminal (pin #2). Take necessary precautions to prevent any conductor not at ground potential from contacting the cap as that could cause a short circuit to GND.
- (10) Do not route any signal lines, supply voltage lines, or GND lines underneath the area where the oscillators are mounted including any internal layers and on the opposite side of the PCB. To avoid any issues due to interference of other signal lines, please take care not to place signal lines near the product as this may have an adverse affect on the performance of the product.
- (11) A bypass capacitor of the recommended value(s) must be connected between the  $V_{CC}$  and GND terminals of the product. Whenever possible, mount the capacitor(s) on the same side of the PCB and as close to the product as possible to keep the routing traces short.
- (12) Power supply connections to  $V_{CC}$  and GND pins should be routed as thick as possible while keeping the high frequency impedance low in order to get the best performance.
- (13) The use of a filter or similar element in series with the power supply connections to protect from electromagnetic radiation noise may increase the high frequency impedance of the power supply line and may cause the oscillator to not operate properly. Please verify the design to ensure sufficient operational margin prior to use.
- (14) Keep PCB routing from the output terminal(s) to the load as short as possible for best performance.
- (15) Do not short the output to GND as that will damage the product. Always use with an appropriate load resistor connected.
- (16) Product failures during the warranty period only apply when the product is used according to the recommended operating conditions described in the specifications. Products that have been opened for analysis or damaged will not be covered. It is recommended to store and use in normal temperature and humidity environments described in the specifications to ensure frequency accuracy and prevent moisture condensation. If the product is stored for more than one year, please confirm the pin solderability prior to use.
- (17) If the oscillation circuit is exposed to condensation, the frequency may change or oscillation may stop. Do not use in any conditions where condensation occurs.
- (18) Do not store or use the product in an environment where it can be exposed to chemical substances that are corrosive to metal or plastics such as salt water, organic solvents, chemical gasses, etc. Do not use the product when it is exposed to sunlight, dust, corrosive gasses, or other materials for long periods of time.
- (19) When using water-soluble solder flux make sure to completely remove the flux residue after soldering. Pay particular attention when the residues contain active halogens which will negatively affect the product and its performance.

## PROMOTION OF ENVIRONMENTAL MANAGEMENT SYSTEM CONFORMING TO INTERNATIONAL STANDARDS

At Seiko Epson, all environmental initiatives operate under the Plan-Do-Check-Action (PDCA) cycle designed to achieve continuous improvements. The environmental management system (EMS) operates under the ISO 14001 environmental management standard.

All of our major manufacturing and non-manufacturing sites, in Japan and overseas, completed the acquisition of ISO 14001 certification.



ISO 14000 is an international standard for environmental management that was established by the International Standards Organization in 1996 against the background of growing concern regarding global warming, destruction of the ozone layer, and global deforestation.

## WORKING FOR HIGH QUALITY

In order provide high quality and reliable products and services than meet customer needs, Seiko Epson made early efforts towards obtaining ISO9000 series certification and has acquired ISO9001 for all business establishments in Japan and abroad. We have also acquired IATF 16949 certification that is requested strongly by major manufacturers as standard.

IATF 16949 is the international standard that added the sector-specific supplemental requirements for automotive industry based on ISO9001.

### ■ Explanation of marks used in this datasheet

	●Pb free.
	●Complies with EU RoHS directive. *About the products without the Pb-free mark. Contains Pb in products exempted by EU RoHS directive (Contains Pb in sealing glass, high melting temperature type solder or other)

NOTICE: PLEASE READ CAREFULLY BELOW BEFORE THE USE OF THIS DOCUMENT ©Seiko Epson Corporation 2020

- The content of this document is subject to change without notice. Before purchasing or using Epson products, please contact with sales representative of Seiko Epson Corporation ("Epson") for the latest information and be always sure to check the latest information published on Epson's official web sites and resources.
- This document may not be copied, reproduced, or used for any other purposes, in whole or in part, without Epson's prior consent.
- Information provided in this document including, but not limited to application circuits, programs and usage, is for reference purpose only. Epson makes no guarantees against any infringements or damages to any third parties' intellectual property rights or any other rights resulting from the information. This document does not grant you any licenses, any intellectual property rights or any other rights with respect to Epson products owned by Epson or any third parties.
- Using Epson products, you shall be responsible for safe design in your products; that is, your hardware, software, and/or systems shall be designed enough to prevent any critical harm or damages to life, health or property, even if any malfunction or failure might be caused by Epson products. In designing your products with Epson products, please be sure to check and comply with the latest information regarding Epson products (including, but not limited to this document, specifications, data sheets, manuals, and Epson's web site). Using technical contents such as product data, graphic and chart, and technical information, including programs, algorithms and application circuit examples under this document, you shall evaluate your products thoroughly both in stand-alone basis and within your overall systems. You shall be solely responsible for deciding whether to adopt/use Epson products with your products.
- Epson has prepared this document carefully to be accurate and dependable, but Epson does not guarantee that the information is always accurate and complete. Epson assumes no responsibility for any damages you incurred due to any misinformation in this document.
- No dismantling, analysis, reverse engineering, modification, alteration, adaptation, reproduction, etc., of Epson products is allowed.
- Epson products have been designed, developed and manufactured to be used in general electronic applications and specifically requires particular quality or extremely high reliability in order to refrain from causing any malfunction or failure leading to critical harm to life and health, serious property damage, or severe impact on society, including, but not limited to listed below ("Specific Purpose"). Therefore, you are strongly advised to use Epson products only for the Anticipated Purpose. Should you desire to purchase and use Epson products for Specific Purpose, Epson makes no warranty and disclaims with respect to Epson products, whether express or implied, including without limitation any implied warranty of merchantability or fitness for any Specific Purpose. Please be sure to contact our sales representative in advance, if you desire Epson products for Specific Purpose:  
Space equipment (artificial satellites, rockets, etc.) / Transportation vehicles and their control equipment (automobiles, aircraft, trains, ships, etc.) / Medical equipment/ Relay equipment to be placed on sea floor/ Power station control equipment / Disaster or crime prevention equipment/Traffic control equipment/ Financial equipment  
Other applications requiring similar levels of reliability as the above
- Epson products listed in this document and our associated technologies shall not be used in any equipment or systems that laws and regulations in Japan or any other countries prohibit to manufacture, use or sell. Furthermore, Epson products and our associated technologies shall not be used for the purposes of military weapons development (e.g. mass destruction weapons), military use, or any other military applications. If exporting Epson products or our associated technologies, please be sure to comply with the Foreign Exchange and Foreign Trade Control Act in Japan, Export Administration Regulations in the U.S.A (EAR) and other export-related laws and regulations in Japan and any other countries and to follow their required procedures.
- Epson assumes no responsibility for any damages (whether direct or indirect) caused by or in relation with your non-compliance with the terms and conditions in this document or for any damages (whether direct or indirect) incurred by any third party that you give, transfer or assign Epson products.
- For more details or other concerns about this document, please contact our sales representative.
- Company names and product names listed in this document are trademarks or registered trademarks of their respective companies.