

## BTFA Series



### Features

- Small size low-profile, low cost and lightweight type
- Wide bandwidth and Omni-directional
- Supported with Dip-type, SMD, and Co-axial cable connecting
- Customized

### Applications

- Bluetooth, Wireless Router, Set Top Box and Home digital
- ISM band, Lora, Sigfox, LTE, NB-IOT, GPS, WiFi and Car use.

### Product Identification

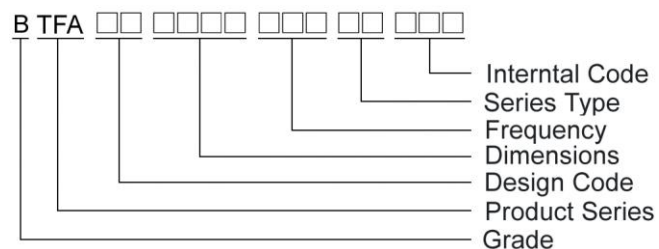

### Shapes and Dimensions

FIG 1

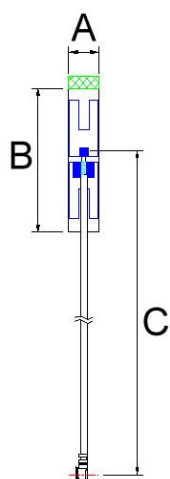

FIG 2

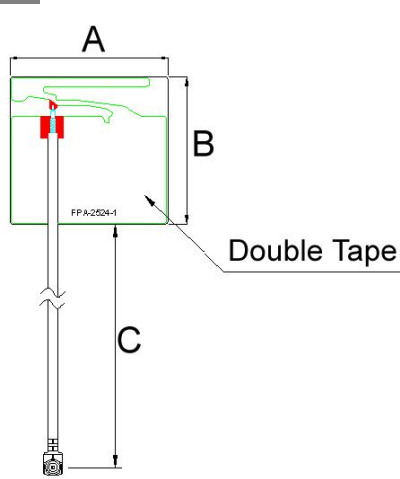
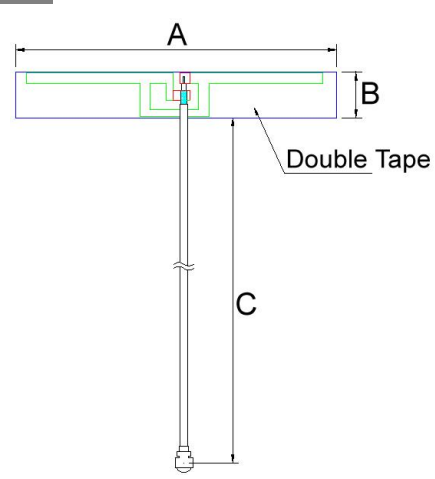

FIG 3



Dimensions in mm

TYPE	FIG	A	B	C
BTFA0024055G0C1A13	1	5.10	24.25	100±5
BTFA00252425GC1A01	2	25.3	23.6	120±5
BTFA0046062G4C1A03	3	46.5	6.65	150±5

## FPC Antenna BTFA Series

### Electrical Characteristics

Part Number	Frequency Range (GHz)	Impedance ( $\Omega$ )	Return Loss dB(Max)	VSWR (Max)	Radiation	Peak Gain (dBi)	Polarization	Admitted Power (W)
BTFA0024055G0C1A13	5.15~5.85	50	-10	2	Omni-directional	4.90	Linear Vertical	1
BTFA00252425GC1A01	2.4~2.5	50	-10	2	Omni-directional	3.37	Linear Vertical	1
	5.15~5.85					2.85		
BTFA0046062G4C1A03	2.4~2.5	50	-10	2	Omni-directional	3.87	Linear Vertical	1

### Physical Properties

Part Number	Antenna Material	Cable	Color	Connector	Double Tape
BTFA0024055G0C1A13	FPC	RF-113	Black	IPEX Compatible	3M 467
BTFA00252425GC1A01	FPC	RF-113	Black	TNOV	G9000
BTFA0046062G4C1A03	FPC	RF-113	Black	TNOV	G9000

- Operating temperature range - 20°C ~ +65°C
- Storage temperature range - 30°C ~ +75°C

## BTFA0024055G0C1A13

### Return Loss S11

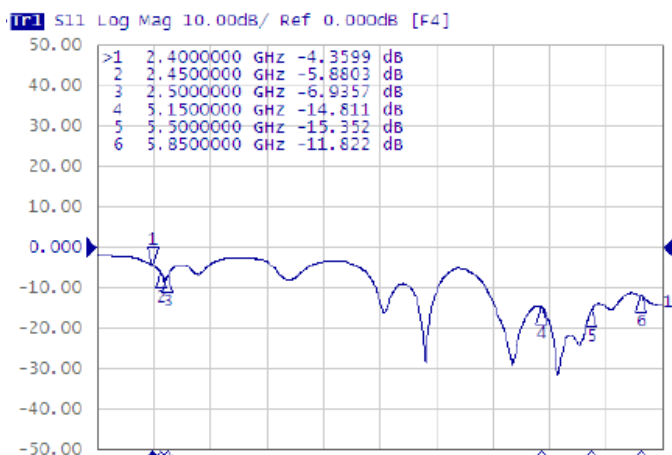

### Frequency(MHz) : 5150~5850. Pattern Field : Z-X plane

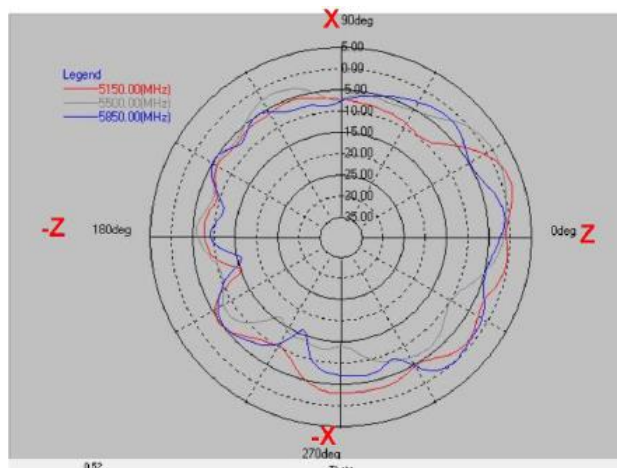

Layer	Max value	Min value	Average
5150(MHz)	2.25 dB	-15.19 dB	-4.15 dB
5500(MHz)	1.46 dB	-16.30 dB	-4.92 dB
5850(MHz)	-0.08 dB	-16.44 dB	-5.02 dB

### Frequency(MHz) : 5150~5850. Pattern Field : Z-Y plane

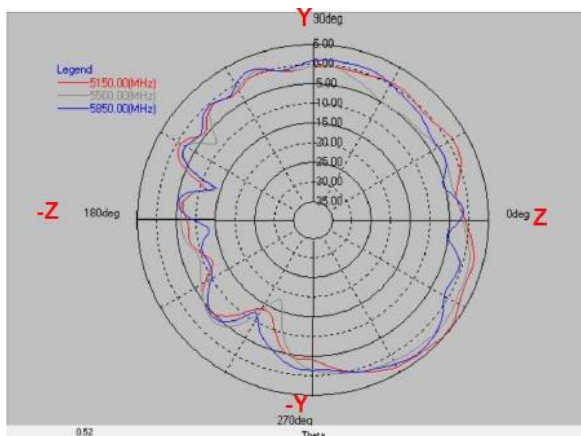

Layer	Max value	Min value	Average
5150(MHz)	4.87 dB	-14.03 dB	-0.64 dB
5500(MHz)	2.90 dB	-18.09 dB	-1.78 dB
5850(MHz)	3.56 dB	-13.87 dB	-1.49 dB

### Frequency(MHz) : 5150~5850. Pattern Field : X-Y plane

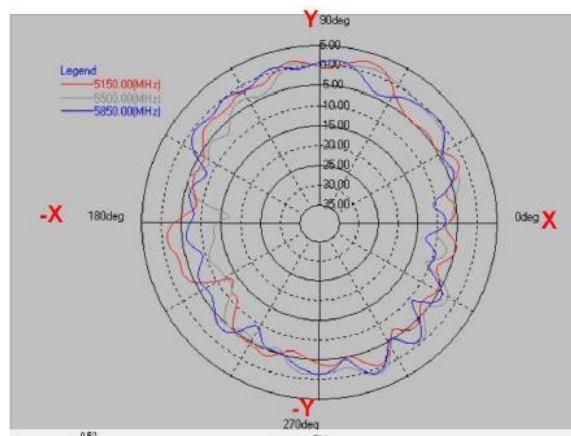

Layer	Max value	Min value	Average
5150(MHz)	2.51 dB	-13.78 dB	-3.22 dB
5500(MHz)	1.30 dB	-17.05 dB	-3.21 dB
5850(MHz)	1.30 dB	-12.85 dB	-3.06 dB

### Frequency(MHz) : 5150. Pattern Field : Z-X plane

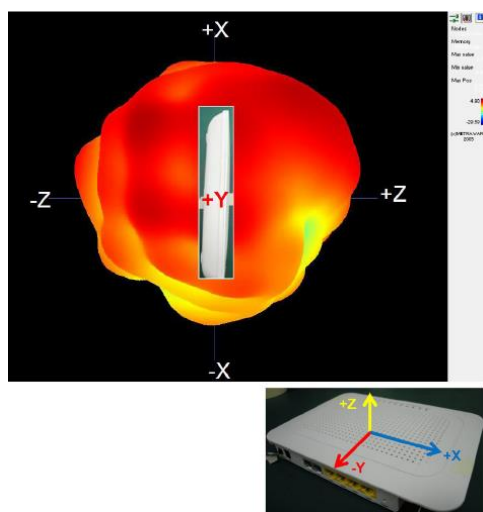

### Frequency(MHz) : 5150. Pattern Field : Z-Y plane

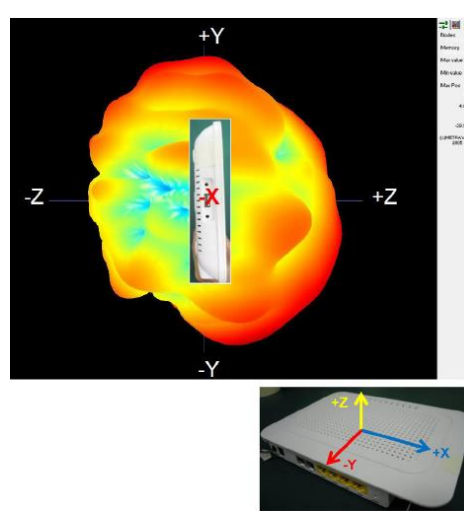

Please be sure to request approval specifications that provide further details of the products. Kindly note that the content of these specifications are subject to change or may be discontinued without prior notice. This product may not be designed/used in medical or high risk applications without Chilisin approval. Please contact our sales department before ordering.

# FPC Antenna BTFA Series

Frequency(MHz) : 5150. Pattern Field : X-Y plane

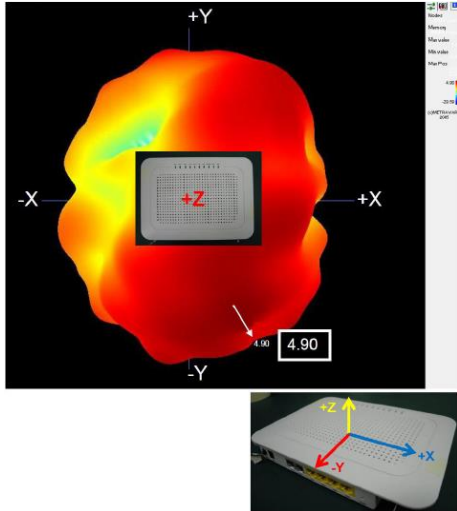

Peak Gain

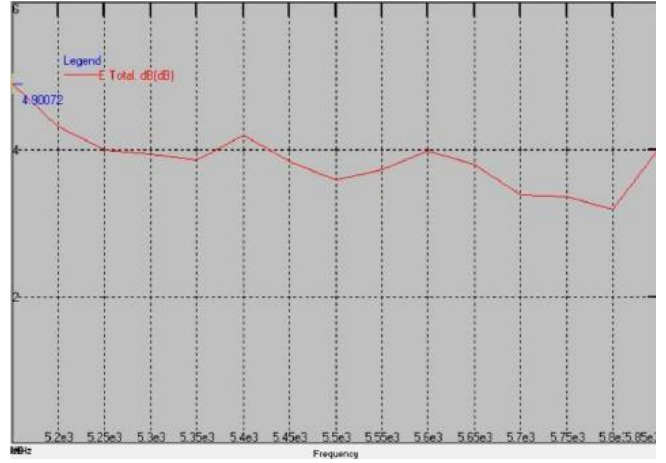

Peak Gain : Max 2.90 dBi

Please be sure to request approval specifications that provide further details of the products. Kindly note that the content of these specifications are subject to change or may be discontinued without prior notice. This product may not be designed/used in medical or high risk applications without Chilisin approval. Please contact our sales department before ordering.

## BTFA00252425GC1A01

### Experimental Setup

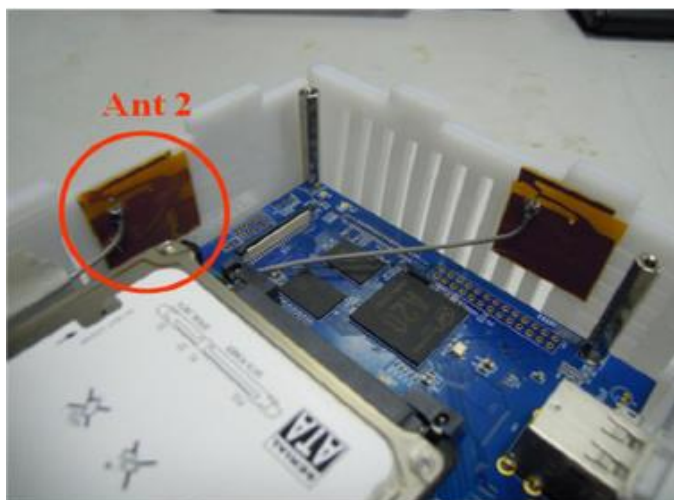
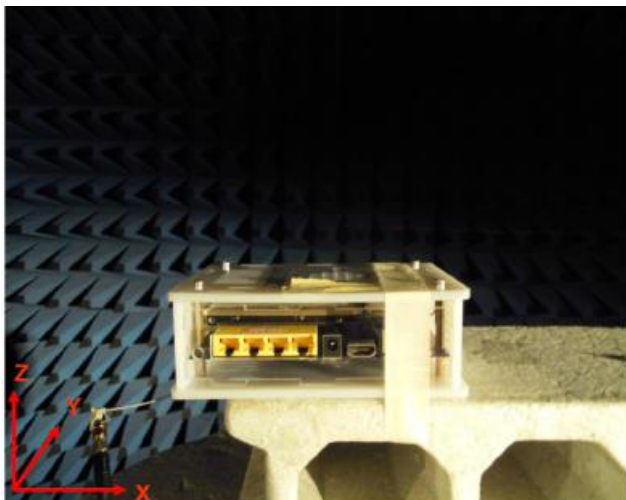

Return Loss S11 : Ant 1 / S22 : Ant 2 / S21 : Isolation

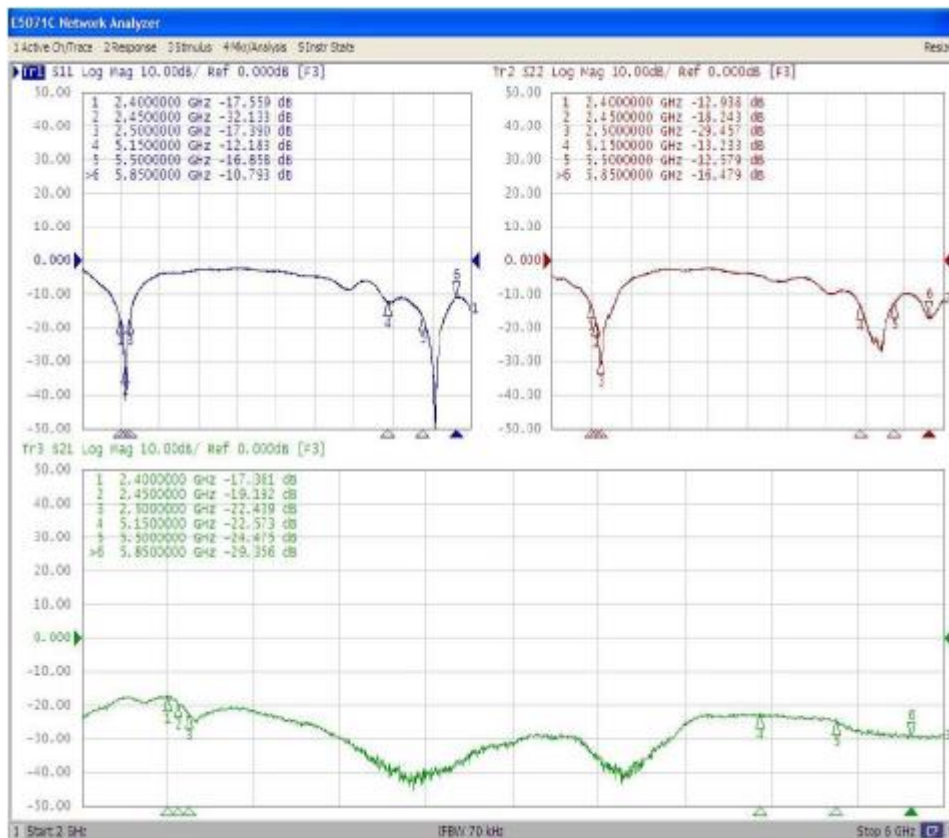

Please be sure to request approval specifications that provide further details of the products. Kindly note that the content of these specifications are subject to change or may be discontinued without prior notice. This product may not be designed/used in medical or high risk applications without Chilisin approval. Please contact our sales department before ordering.

# FPC Antenna BTFA Series

Frequency(MHz) : 2400~2500. X-Z Plane

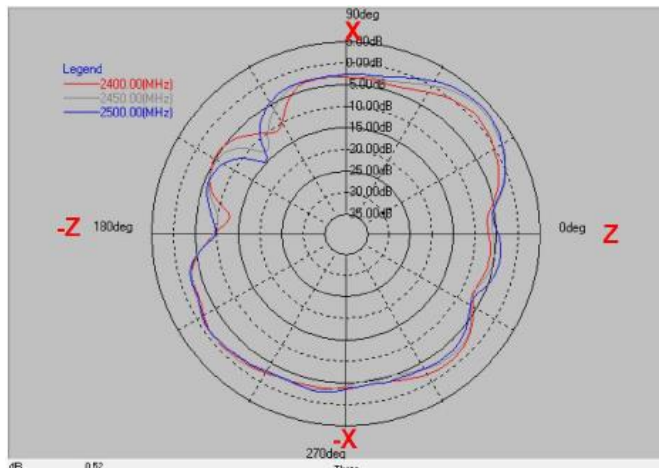

Layer	Max value	Min value	Average
2400(MHz)	0.91 dB	-12.85 dB	-3.42 dB
2450(MHz)	2.89 dB	-13.34 dB	-2.76 dB
2500(MHz)	3.37 dB	-14.94 dB	-2.46 dB

Frequency(MHz) : 2400~2500. Y-Z Plane

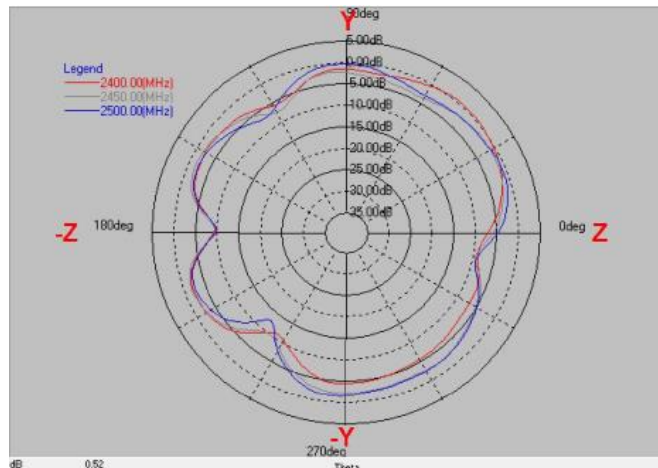

Layer	Max value	Min value	Average
2400(MHz)	0.42 dB	-11.32 dB	-3.63 dB
2450(MHz)	-1.19 dB	-10.21 dB	-3.66 dB
2500(MHz)	-0.46 dB	-12.89 dB	-3.34 dB

Frequency(MHz) : 2400~2500. X-Y Plane

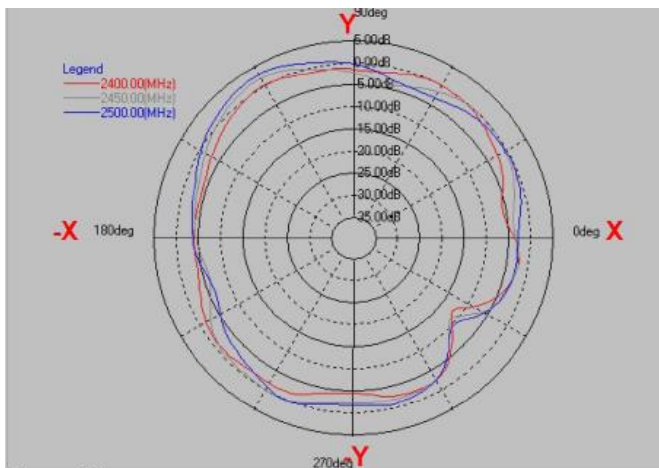

Layer	Max value	Min value	Average
2400(MHz)	0.10 dB	-12.12 dB	-2.49 dB
2450(MHz)	1.92 dB	-11.26 dB	-1.82 dB
2500(MHz)	2.81 dB	-9.85 dB	-1.50 dB

Frequency(MHz) : 5150~5850. X-Z Plane

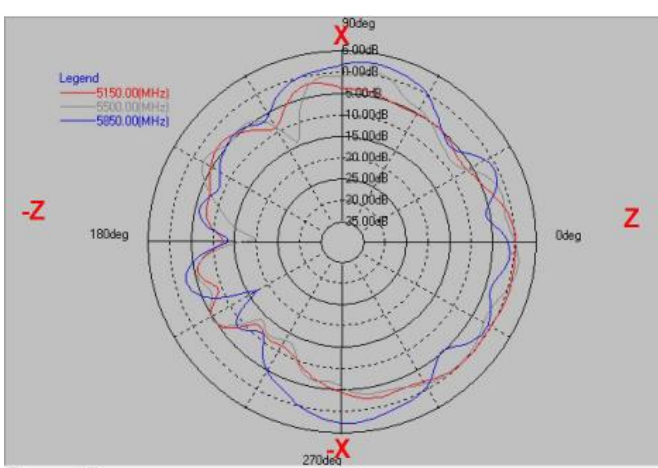

Layer	Max value	Min value	Average
5150(MHz)	0.54 dB	-12.50 dB	-3.69 dB
5500(MHz)	1.28 dB	-20.11 dB	-3.52 dB
5850(MHz)	2.60 dB	-17.20 dB	-1.90 dB

Frequency(MHz) : 5150~5850. Y-Z Plane

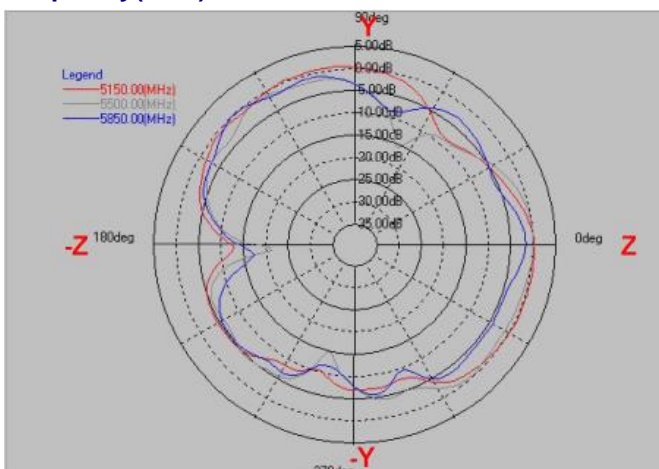

Layer	Max value	Min value	Average
5150(MHz)	0.45 dB	-12.88 dB	-2.70 dB
5500(MHz)	0.18 dB	-21.21 dB	-3.68 dB
5850(MHz)	-0.12 dB	-17.40 dB	-4.46 dB

Frequency(MHz) : 5150~5850. X-Y Plane

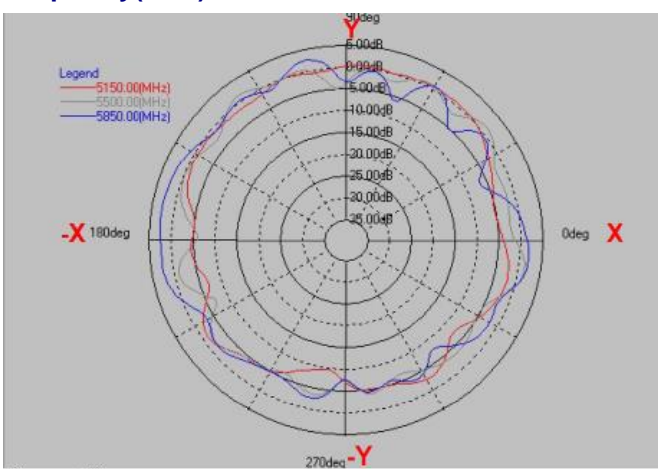

Layer	Max value	Min value	Average
5150(MHz)	0.59 dB	-9.84 dB	-2.47 dB
5500(MHz)	1.49 dB	-7.77 dB	-1.98 dB
5850(MHz)	2.85 dB	-8.05 dB	-0.94 dB

Please be sure to request approval specifications that provide further details of the products. Kindly note that the content of these specifications are subject to change or may be discontinued without prior notice. This product may not be designed/used in medical or high risk applications without Chilisin approval. Please contact our sales department before ordering.

BTFA0046062G4C1A03

Experimental Setup

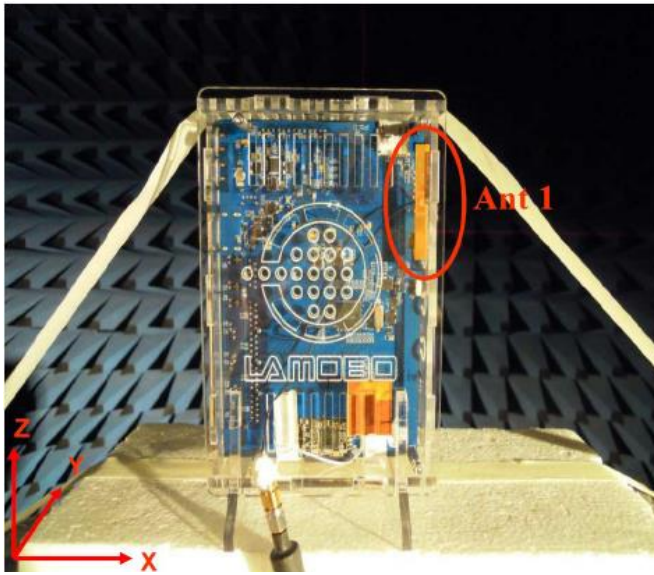

Return Loss S11 : Ant 1 / S22 : Ant 2 / S21 : Isolation

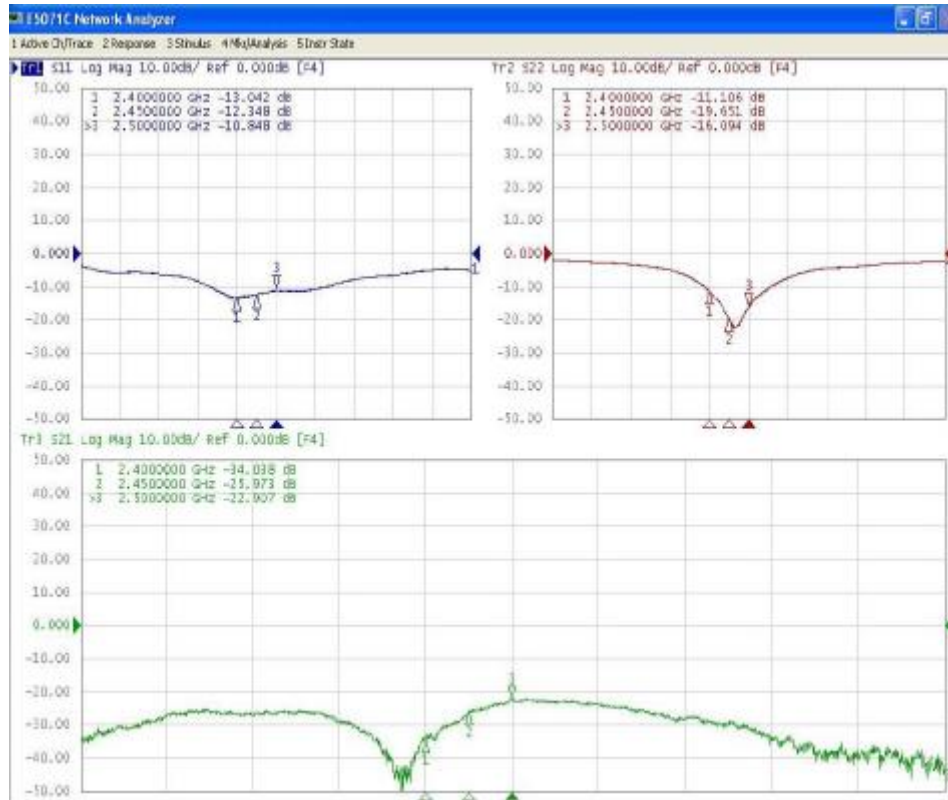

Please be sure to request approval specifications that provide further details of the products. Kindly note that the content of these specifications are subject to change or may be discontinued without prior notice. This product may not be designed/used in medical or high risk applications without Chilisin approval. Please contact our sales department before ordering.

# FPC Antenna BTFA Series

Frequency(MHz) : 2400~2500. Z- X Plane

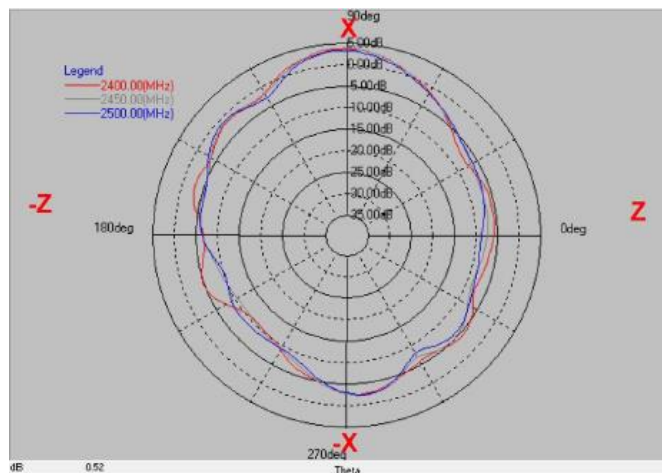

Layer	Max value	Min value	Average
2400(MHz)	3.48 dB	-10.84 dB	-2.85 dB
2450(MHz)	3.72 dB	-10.91 dB	-3.04 dB
2500(MHz)	3.12 dB	-10.28 dB	-3.40 dB

Frequency(MHz) : 2400~2500. Z- Y Plane

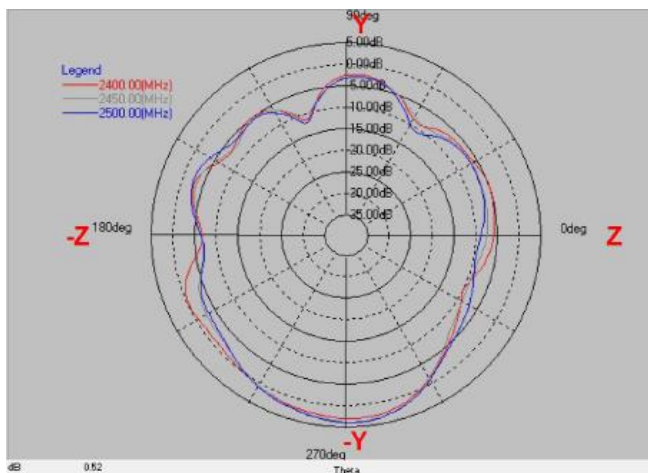

Layer	Max value	Min value	Average
2400(MHz)	2.89 dB	-11.62 dB	-2.50 dB
2450(MHz)	3.86 dB	-10.53 dB	-2.62 dB
2500(MHz)	3.76 dB	-12.27 dB	-2.56 dB

Frequency(MHz) : 2400~2500. X- Y Plane

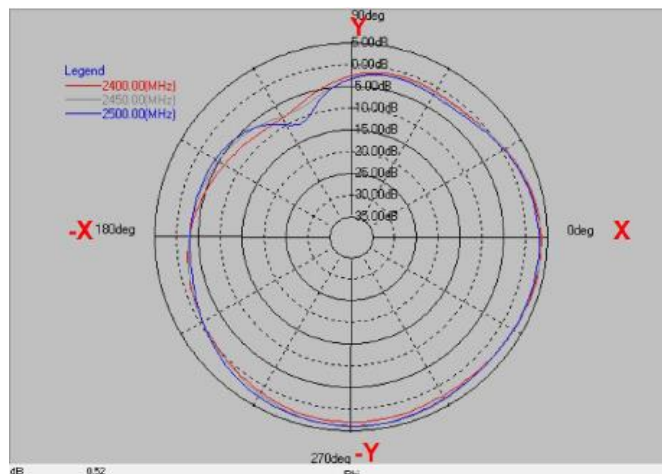

Layer	Max value	Min value	Average
2400(MHz)	3.65 dB	-8.49 dB	0.50 dB
2450(MHz)	3.87 dB	-8.27 dB	0.87 dB
2500(MHz)	3.74 dB	-11.43 dB	0.72 dB

Please be sure to request approval specifications that provide further details of the products. Kindly note that the content of these specifications are subject to change or may be discontinued without prior notice. This product may not be designed/used in medical or high risk applications without Chilisin approval. Please contact our sales department before ordering.