



# PBHV8110DH

## NPN Low Vce(sat) Transistor

**Voltage**

**100V**

**Current**

**1A**

### Features

- Silicon NPN epitaxial type
- Low Vce(sat) 0.35V(max)@Ic/Ib= 500mA / 50mA
- High collector current capability
- Excellent DC current gain characteristics
- Lead free in compliance with EU RoHS 2.0
- Green molding compound as per IEC61249 Standard
- PNP complement: PBHV9110DH

### Mechanical Data

- Case: SOT-89 Package
- Terminals : Solderable per MIL-STD-750, Method 2026
- Approx. Weight: 0.002 ounces, 0.057 grams
- Marking: 811D

**SOT-89**

**Unit: inch(mm)**

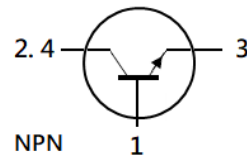
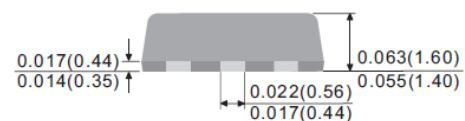
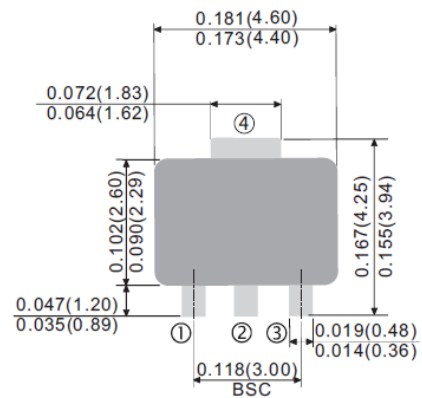

**Pin Assignment:**

1. Base
- 2.4. Collector
3. Emitter

## Maximum Ratings and Thermal Characteristics (T<sub>A</sub>=25 °C unless otherwise noted)

PARAMETER	SYMBOL	LIMIT	UNITS
Collector-Base Voltage	V <sub>CBO</sub>	120	V
Collector-Emitter Voltage	V <sub>CEO</sub>	100	V
Emitter-Base Voltage	V <sub>EBO</sub>	6	V
Collector Current (DC)	I <sub>C</sub>	1	A
Collector Current (Pulse)	I <sub>CP</sub>	3	A
Power Dissipation	P <sub>D</sub>	1.4	W
Junction Temperature	T <sub>J</sub>	150	°C
Operating Junction and Storage Temperature Range	T <sub>J</sub> , T <sub>STG</sub>	-55~150	°C
Thermal Resistance from Junction to Ambient <sup>(Note)</sup>	R <sub>θJA</sub>	89	°C/W

Note: Mounted on FR4 PCB at 1 inch square copper pad.



# PBHV8110DH

## Electrical Characteristics ( $T_A=25^{\circ}\text{C}$ unless otherwise noted)

PARAMETER	SYMBOL	TEST CONDITION	MIN.	TYP.	MAX.	UNITS
<b>OFF Characteristics</b>						
Collector-Emitter Breakdown Voltage	$BV_{CEO}$	$I_C=10\text{mA}, I_B=0\text{A}$	100	-	-	V
Collector-Base Breakdown Voltage	$BV_{CBO}$	$I_C=0.1\text{mA}, I_E=0\text{A}$	120	-	-	V
Emitter-Base Breakdown Voltage	$BV_{EBO}$	$I_E=0.1\text{mA}, I_C=0\text{A}$	6	-	-	V
Collector Cutoff Current	$I_{CBO}$	$V_{CB}=120\text{V}, I_E=0\text{A}$	-	-	500	nA
Emitter Cutoff Current	$I_{EBO}$	$V_{EB}=6\text{V}, I_C=0\text{A}$	-	-	500	nA
<b>ON characteristics</b>						
DC Current Gain (Note1)	$h_{FE}$	$V_{CE}=2\text{V}, I_C=150\text{mA}$	140	-	330	-
		$V_{CE}=5\text{V}, I_C=500\text{mA}$	100	-	300	
		$V_{CE}=5\text{V}, I_C=1\text{A}$	40	-	-	
Collector-Emitter Saturation Voltage (Note1)	$V_{CE(SAT)}$	$I_C=0.1\text{A}, I_B=10\text{mA}$	-	38	120	mV
		$I_C=0.5\text{A}, I_B=50\text{mA}$	-	117	350	
		$I_C=1\text{A}, I_B=0.1\text{A}$	-	220	450	
Base-Emitter Saturation voltage (Note1)	$V_{BE(SAT)}$	$I_C=0.1\text{A}, I_B=10\text{mA}$	-	-	1.0	V
		$I_C=0.5\text{A}, I_B=50\text{mA}$	-	-	1.1	
Transition Frequency	$f_T$	$V_{CE}=5\text{V}, I_E=-50\text{mA}$	100	-	-	MHz
Collector Output Capacitance	$C_{OB}$	$V_{CB}=10\text{V}, I_E=0\text{A},$ $f=1\text{MHz}$	-	-	10	pF

Note: 1. Pulse width  $\leq 300\mu\text{s}$ , Duty cycle  $\leq 2\%$



# PBHV8110DH

## TYPICAL CHARACTERISTIC CURVES

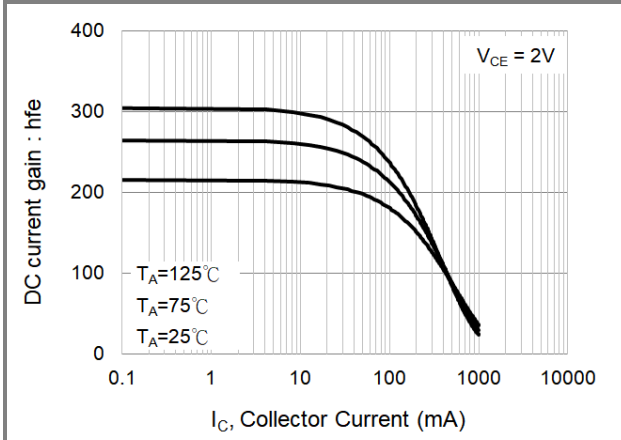

Fig.1 DC Current Gain

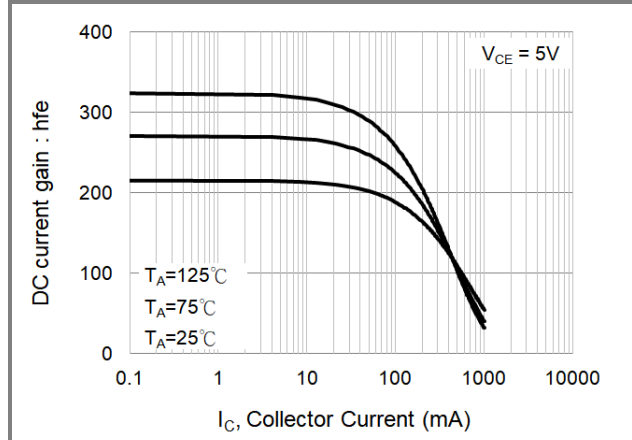

Fig.2 DC Current Gain

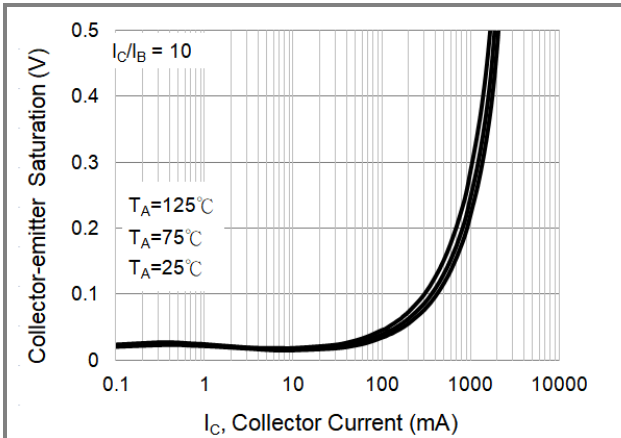

Fig.3 Collector-Emitter Saturation Voltage

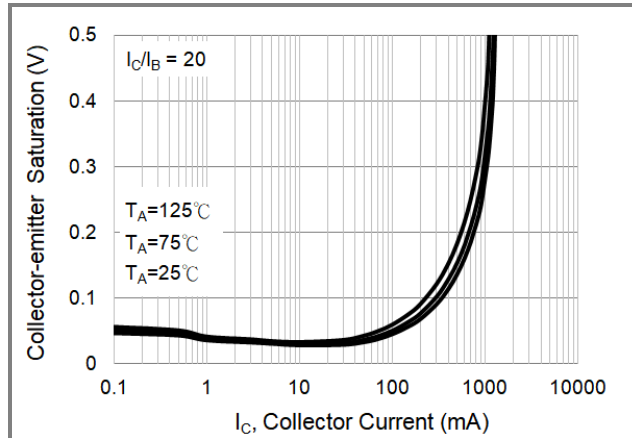

Fig.4 Collector-Emitter Saturation Voltage

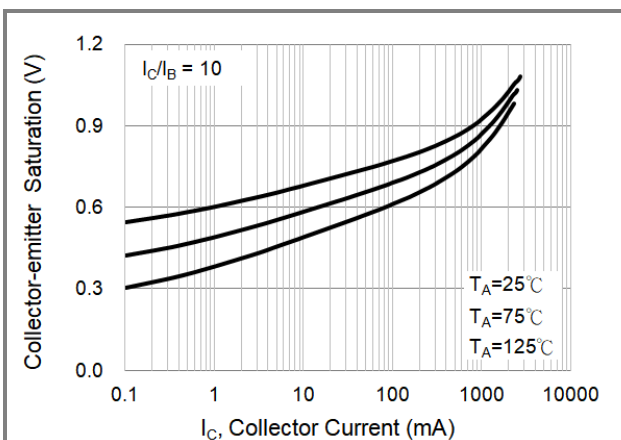

Fig.5 Base-Emitter Saturation Voltage

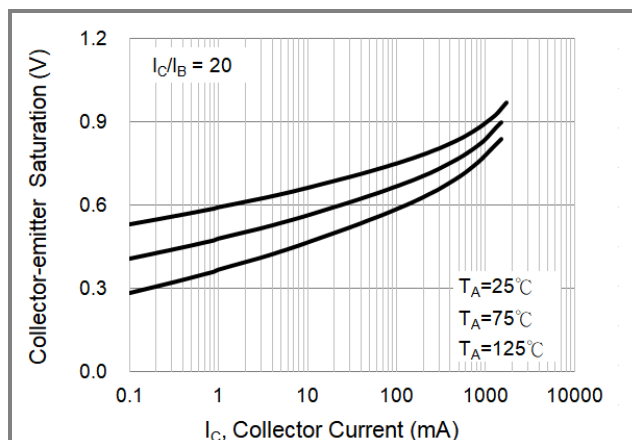

Fig.6 Base-Emitter Saturation Voltage



# PBHV8110DH

## TYPICAL CHARACTERISTIC CURVES

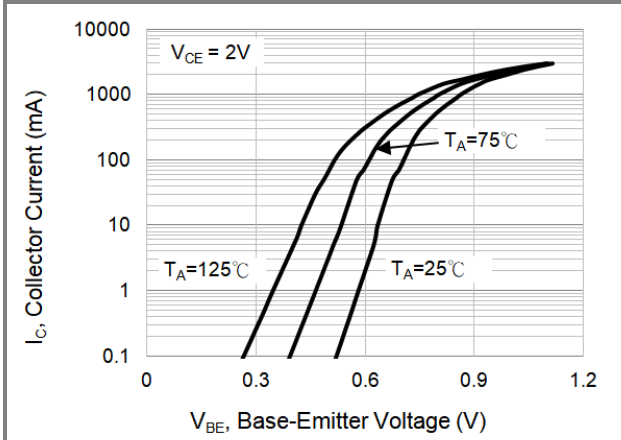

Fig.7 Base-Emitter Voltage

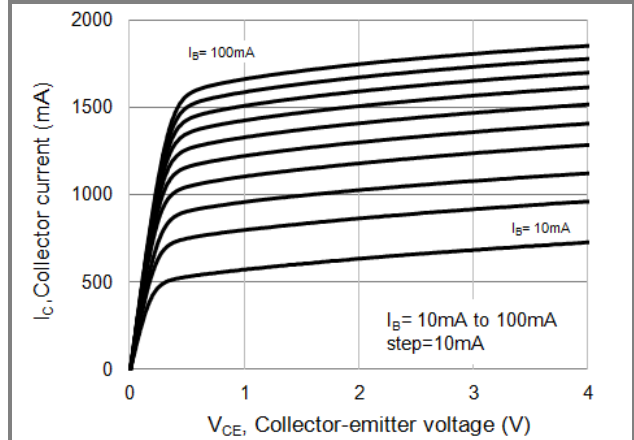

Fig.8 Collector Current

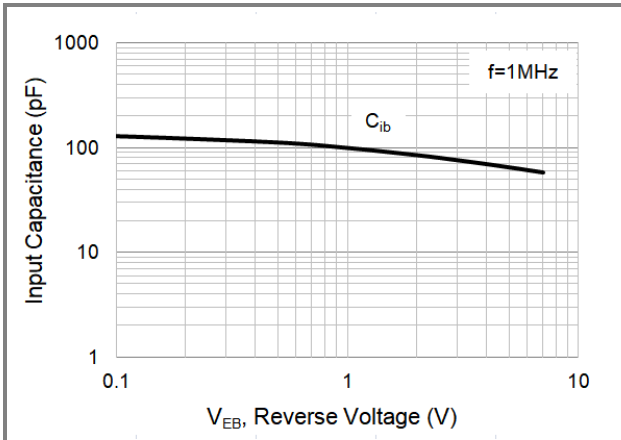

Fig.9 Input Capacitance

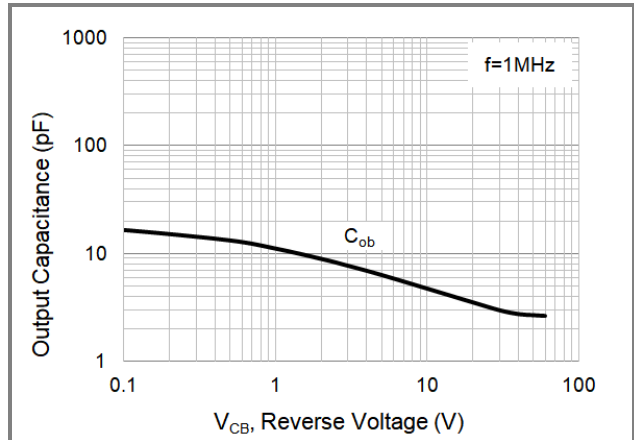

Fig.10 Output Capacitance

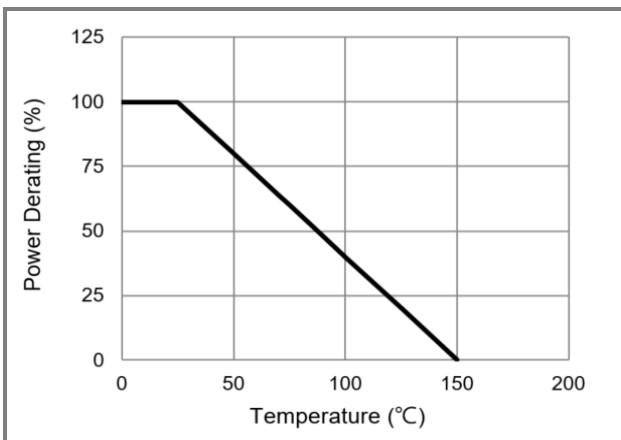

Fig.11 Power Derating Curve



# PBHV8110DH

## PART NO PACKING CODE VERSION

Part No Packing Code	Package Type	Packing type	Marking	Version
PBHV8110DH_R1_00001	SOT-89	1k pcs / 7" reel	811D	Halogen free

## MOUNTING PAD LAYOUT

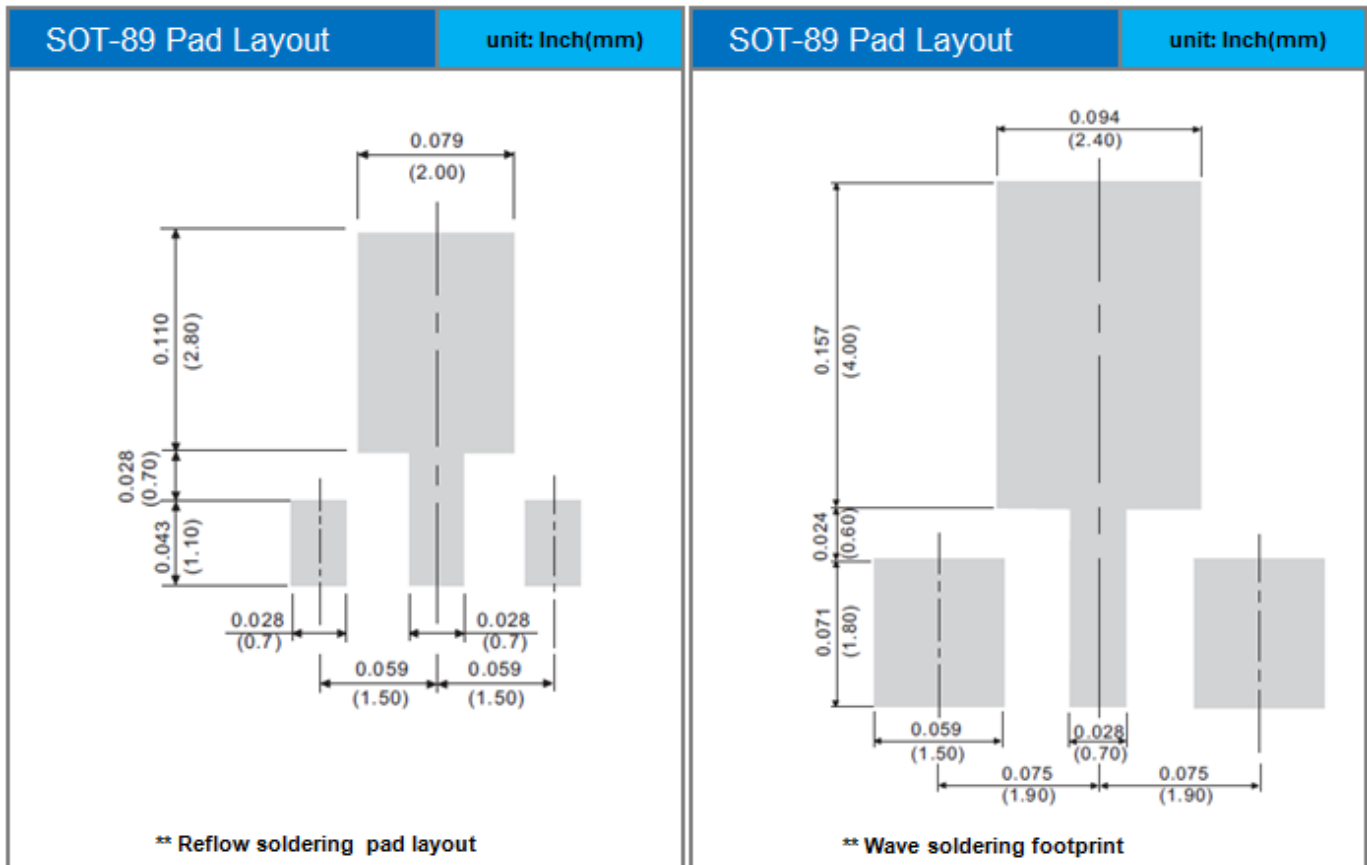



## **PBHV8110DH**

### Disclaimer

- Reproducing and modifying information of the document is prohibited without permission from Panjit International Inc..
- Panjit International Inc. reserves the rights to make changes of the content herein the document anytime without notification. Please refer to our website for the latest document.
- Panjit International Inc. disclaims any and all liability arising out of the application or use of any product including damages incidentally and consequentially occurred.
- Panjit International Inc. does not assume any and all implied warranties, including warranties of fitness for particular purpose, non-infringement and merchantability.
- Applications shown on the herein document are examples of standard use and operation. Customers are responsible in comprehending the suitable use in particular applications. Panjit International Inc. makes no representation or warranty that such applications will be suitable for the specified use without further testing or modification.
- The products shown herein are not designed and authorized for equipments requiring high level of reliability or relating to human life and for any applications concerning life-saving or life-sustaining, such as medical instruments, transportation equipment, aerospace machinery et cetera. Customers using or selling these products for use in such applications do so at their own risk and agree to fully indemnify Panjit International Inc. for any damages resulting from such improper use or sale.
- Since Panjit uses lot number as the tracking base, please provide the lot number for tracking when complaining.

# Mouser Electronics

Authorized Distributor

Click to View Pricing, Inventory, Delivery & Lifecycle Information:

[Panjit:](#)

[PBHV8110DH\\_R1\\_00001](#)