

NEC[®]**SILICON CW IMPATT DIODE****ND8
SERIES****FEATURES**

- **HIGH POWER OUTPUT AND WIDE FREQUENCY SELECTION**
3.50 W at 8 GHz
3.00 W at 11 GHz
2.20 W at 15 GHz
1.20 W at 20 GHz
0.70 W at 30 GHz
0.40 W at 40 GHz
0.20 W at 60 GHz
0.10 W at 80 GHz
0.05 W at 94 GHz
- **HIGH EFFICIENCY**
12% at 8 GHz
4% at 94 GHz
- **SILICON SINGLE DRIFT REGION (SDR) AND DOUBLE DRIFT REGION (DDR)**
- **DIAMOND HEAT SINKS (DHS) COPPER HEAT SINKS (CHS)**
- **HIGH RELIABILITY FOR INDUSTRIAL AND MILITARY APPLICATIONS**

DESCRIPTION AND APPLICATIONS

The NEC CW IMPATT diode series includes a broad spectrum of diodes from low cost SDR with CHS to high power DDR with DHS types covering the 6 GHz to 100 GHz microwave region. The single drift region (SDR) IMPATT diode is a flat profile P⁺NN⁺ epitaxial mesa with an integral heat sink, and the double drift region (DDR) diode is a flat profile P⁺PNN⁺ integral heat sink epitaxial mesa structure.

Applications are IMPATT amplifiers and oscillators for industrial, space, and military systems. These include point to point communications, radar, radiometers, jammers, fuses, DME, speed detectors, intrusion alarms, beacons, and height finders. Reliability screening is available upon request.

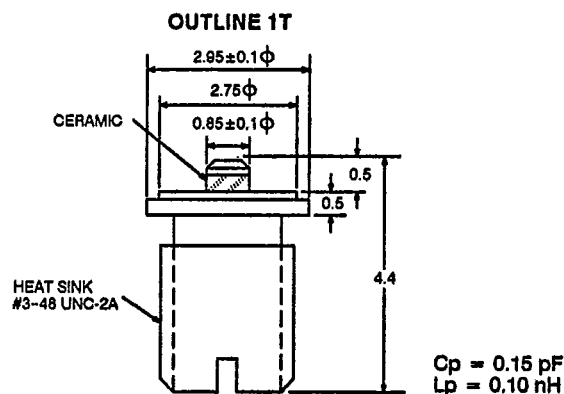
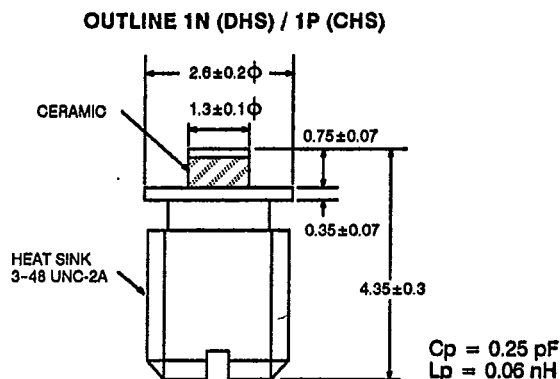
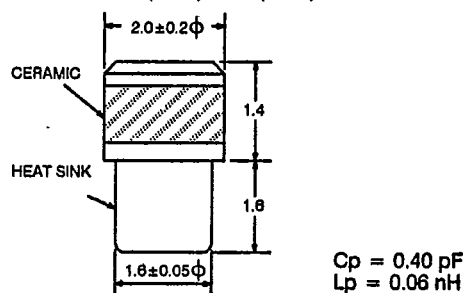
OUTLINE DIMENSIONS (Units in mm)**OUTLINE 5H (DHS) / 5G (CHS)**

Note: Heatsinks are Anodes

ABSOLUTE MAXIMUM RATINGS (T_A = 25°C)

SYMBOLS	IMPACT TYPE		RATINGS	SDR RATINGS
	PARAMETERS	UNITS		
P _T	Total Power Dissipation	W	(250-T _C)/R _{TH (J-C)} (200-T _C)/R _{TH (J-C)}	(200-T _C)/R _{TH (J-C)}
T _{OP}	Operating Temperature	°C	-65 to +250	-65 to +200
T _{STG}	Storage Temperature	°C	-65 to +200	-65 to +200
T _{SDR}	Soldering Temperature	°C	230 for 10 sec.	230 for 10 sec.
ΔT _{J (AVE)}	Average Junction Temperature Rise	°C	250	200

PERFORMANCE SPECIFICATIONS (T_A = 25°C)

SYMBOLS	PARAMETERS AND CONDITIONS	UNITS	ND8P08-5G 1ST11 5G SDR COPPER			ND8S08-5H 1ST15 5H SDR DIAMOND			ND8U08W-5H 1ST20 5H DDR DIAMOND			ND8O11-5G 1ST12 5G SDR COPPER			ND8R11-5H 1ST16 5H SDR DIAMOND			ND8T11W-5H 1ST21 5H DDR DIAMOND		
			MIN	TYP	MAX	MIN	TYP	MAX	MIN	TYP	MAX	MIN	TYP	MAX	MIN	TYP	MAX	MIN	TYP	MAX
f	Frequency Range ²	GHZ	6	8	9	6	8	9	6	8	9	6	8	9	9	11	12	9	11	12
P _{OUT}	Power Output	W	1	1.2		2	2.2		3.5	4		0.7	0.8		1.6	1.8	3	3.3		
η	Efficiency	%		7.6			8			12			7.1			7.8				
V _{OP}	Operating Voltage	V	120	135		125	140		170	180		85	95		95	105				
I _{OP}	Operating Current	mA	130	150		220	260		190	200		140	160		240	260				
BV	Breakdown Voltage, I _R = 1 mA	V	95			95			135			70			70					
C _{J (BV-1)}	Junction Capacitance, V _R = BV-1	pF	0.45			0.50			0.40			0.55			0.65					
R _{TH (J-C)}	Thermal Resistance	°C/W	10			6			6			14			6					

Notes:

1. Electronic Industrial Association of Japan.
2. ΔT_{J (AVE)} = (V_{OP} × I_{OP} - P_{OUT}) / R_{TH (J-A)}



ND8 SERIES

PERFORMANCE SPECIFICATIONS (T_A = 25°C)

SYMBOLS	PARAMETERS AND CONDITIONS	UNITS	ND8N15-5G 1ST13 5G SDR COPPER		ND8P15-5H 1ST17 5H SDR DIAMOND		ND8S15W-1N, 5H 1ST22 1N, 5H DDR DIAMOND		ND8M20-5G 1ST14 5G SDR COPPER		ND8C20-5H 1ST18 5H SDR DIAMOND		ND8P20W-5H 1ST23 5H DDR DIAMOND				
			MIN	TYP	MAX	MIN	TYP	MAX	MIN	TYP	MAX	MIN	TYP	MAX	MIN	TYP	MAX
f	Frequency Range ²	GHz	12	15	189	12	15	18	12	15	18	18	20	25	18	20	25
P _{OUT}	Power Output	W	0.5	0.7		1	1.2		0.3	0.4		0.7	0.8		1.2	1.5	
η	Efficiency	%		7.1			7.5			5			6.9			10.0	
V _{OP}	Operating Voltage	V		65	73		70	80		50	55		50	60		80	90
I _{OP}	Operating Current	mA		150	170		230	260		160	180		230	260		185	240
BV	Breakdown Voltage, I _R = 1 mA	V		52			52			38			38			65	
C _J (BV-1)	Junction Capacitance, V _R = BV-1	pF		0.45			0.55			0.40			0.45			0.35	
R _{TH} (J-C)	Thermal Resistance	°C/W		108			9			23			12			12	

Notes:

1. Electronic Industrial Association of Japan.
2. ΔT_{J(AVE)} = (V_{OP} × I_{OP} - P_{OUT}) / (R_{TH} (J-A))

SYMBOLS	PARAMETERS AND CONDITIONS	UNITS	ND8M30-1N 1N SDR DIAMOND		ND8O30W-1N 1N DDR DIAMOND		ND8N40W-1N 1N DDR DIAMOND		ND8L60W-1T 1T DDR DIAMOND		ND8J80W-1T 1T DDR DIAMOND		ND8C96W-1T 1T DDR DIAMOND				
			MIN	TYP	MAX	MIN	TYP	MAX	MIN	TYP	MAX	MIN	TYP	MAX	MIN	TYP	MAX
f	Frequency Range ²	GHz	25	30	35	25	30	35	35	40	50	50	60	70	80	87	100
P _{OUT}	Power Output	W	0.30	0.35		0.70	0.80		0.20	0.30		0.10	0.15		0.10	0.15	0.06
η	Efficiency	%		6.5			10			6			4.5				4
V _{OP}	Operating Voltage	V		40			55	60		32	35		21	23		20	22
I _{OP}	Operating Current	mA		135			145	170		160	200		160	200		100	160
BV	Breakdown Voltage, I _R = 1 mA	V		32			45			25			16			15	
C _J (BV-1)	Junction Capacitance, V _R = BV-1	pF		0.25			0.25			0.20			0.15			0.10	
R _{TH} (J-C)	Thermal Resistance	°C/W		30			25			40			60			80	

Notes:

1. Electronic Industrial Association of Japan.
2. ΔT_{J(AVE)} = (V_{OP} × I_{OP} - P_{OUT}) / (R_{TH} (J-A))

TEST OSCILLATOR DIMENSIONS

FREQUENCY	WAVEGUIDE	L1	L2	L3	L4	D1	D2	D3	D4	H
6-6 GHz	WR-159	$n\lambda g/2$	$n\lambda g$	15-5	25-18	6.5	4	6.5	6-5	6
7-8.2 GHz	WR-137	$n\lambda g/2$	$n\lambda g$	13-4	20-10	6.5	3.8	6.5	6-5	5
8-10 GHz	WR-112	$n\lambda g/2$	$n\lambda g$	10-3	16-9	6.4	3.6	6.4	6-5	4
10-12.4 GHz	WR-90	$n\lambda g/2$	$n\lambda g$	8-2	12-8	6	3.4	6	4.6-5	3
12-14 GHz	WR-75	$n\lambda g/2$	$n\lambda g$	7-1.5	10-5	5.5	3.4	5.5	4.4-4	2
13-18 GHz	WR-62	$n\lambda g/2$	$n\lambda g$	6-1.5	8-3.6	5	3	5	4-3.6	1.5
17-22 GHz	WR-51	$n\lambda g/2$	$n\lambda g$	6-1	6-3.6	4	2.4	4	3.4-2.8	1
22-33 GHz	WR-34	$n\lambda g/2$	$n\lambda g$	4-0.5	6-2.5	3.1	2.4	3.1	2.5-2	1
27-40 GHz	WR-28	$n\lambda g/2$	$n\lambda g$	2-0.5	5-2.5	3.1	1.2	3.1	2.5-2	1

COAXIAL-WAVEGUIDE TEST MOUNT

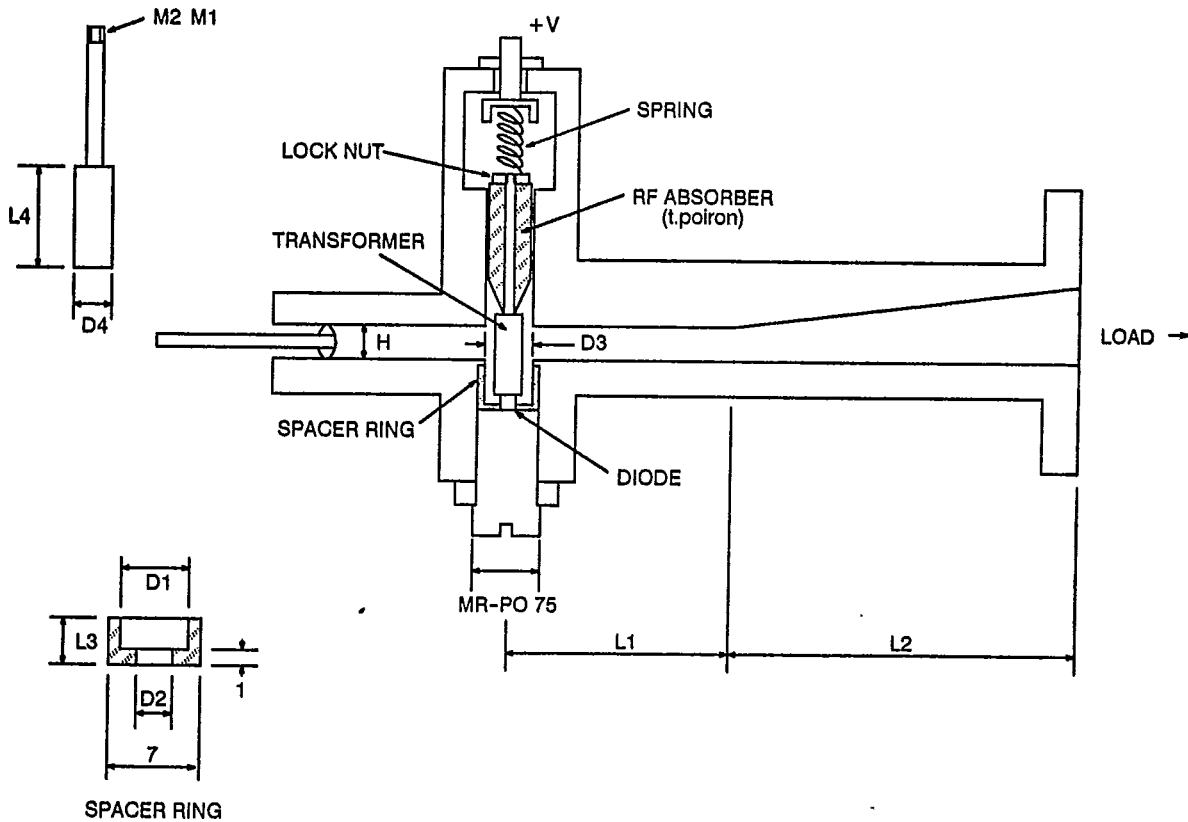

ND8 SERIES

TYPICAL PERFORMANCE CHARACTERISTICS ($T_A = 25^\circ\text{C}$)

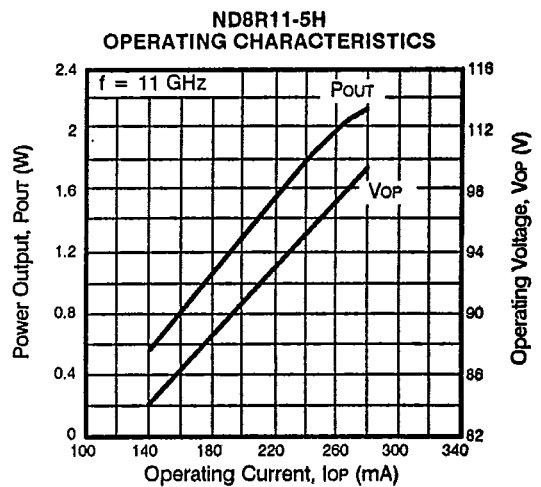
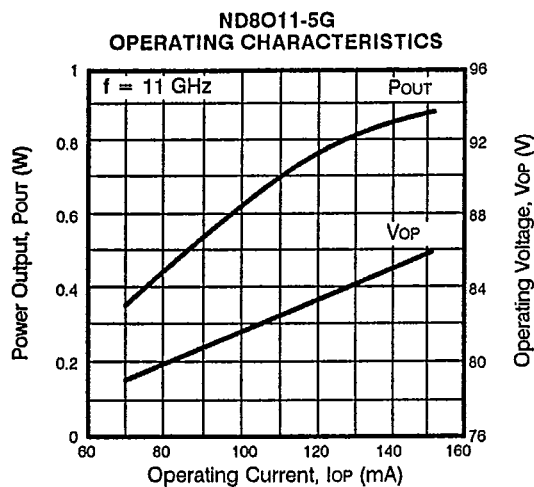
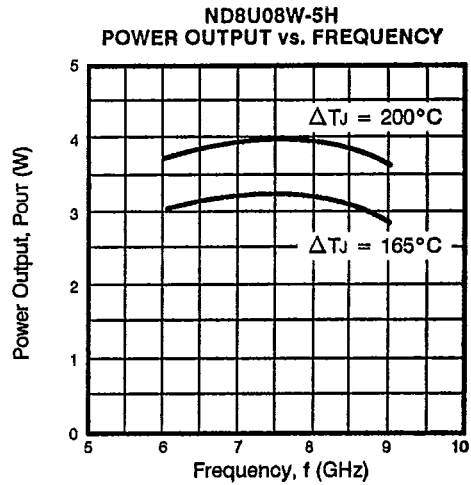
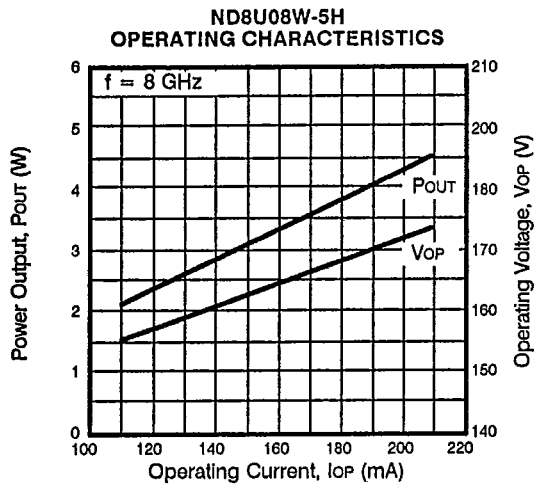
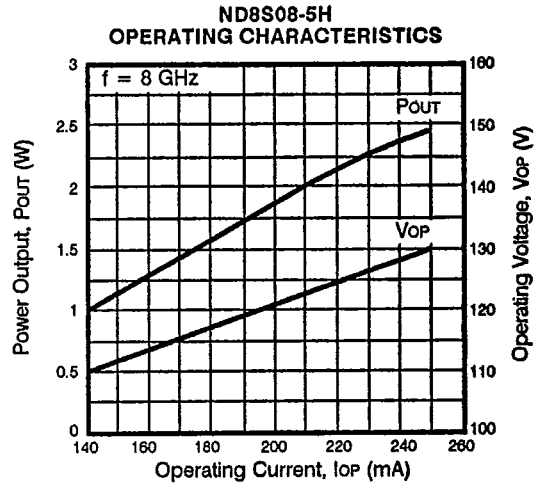
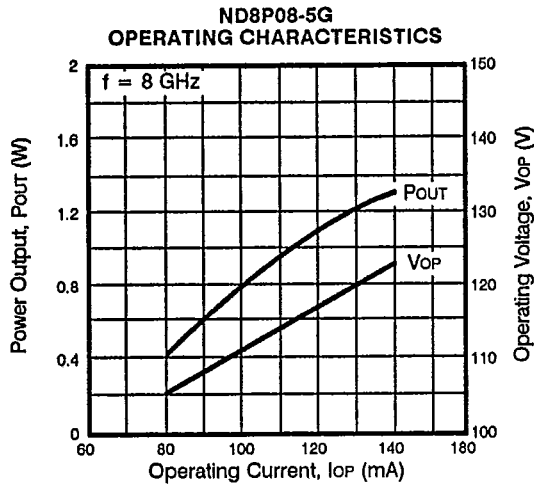

TYPICAL PERFORMANCE CHARACTERISTICS (TA = 25°C)

ND8T11W-5H
OPERATING CHARACTERISTICS

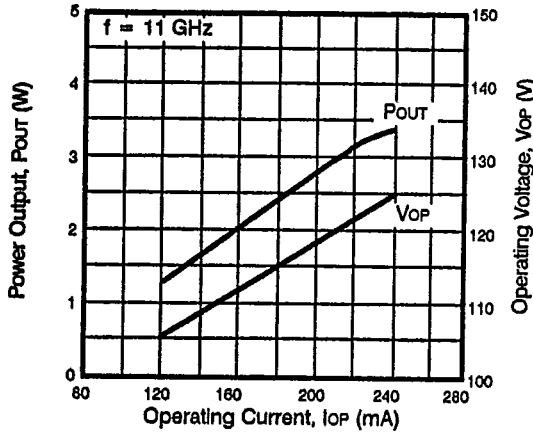

ND8T11W-5H
POWER OUTPUT vs. FREQUENCY

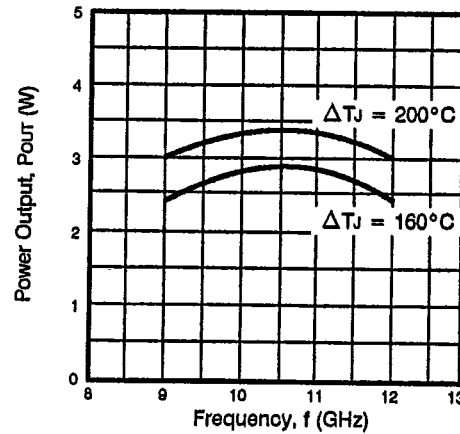

ND8N15-5G
OPERATING CHARACTERISTICS

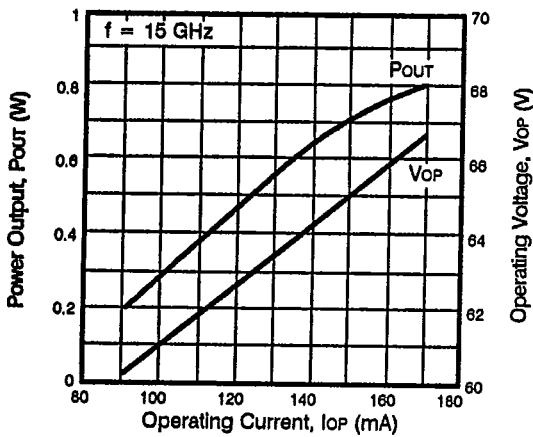

ND8P15-5H
OPERATING CHARACTERISTICS

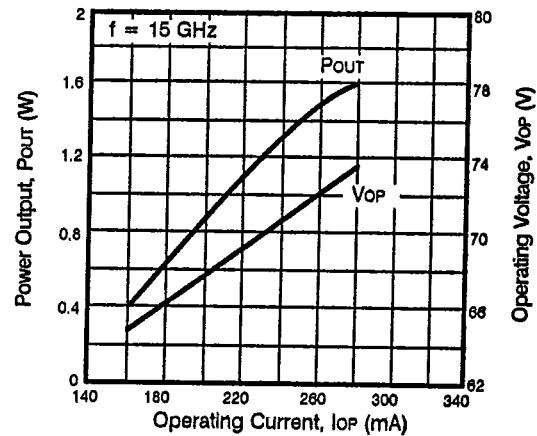

ND8S15W-1N, ND8S15W-5H
OPERATING CHARACTERISTICS

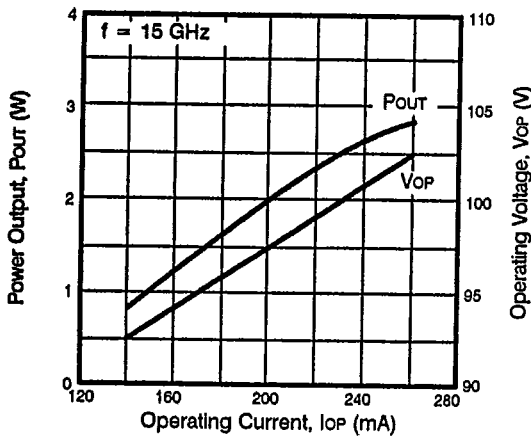

ND8S15W-1N, ND8S15W-5H
POWER OUTPUT vs. FREQUENCY

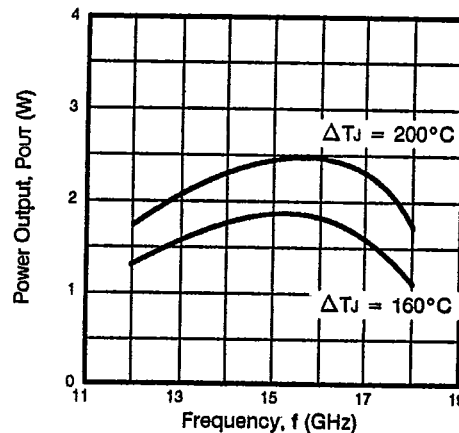

ND8 SERIES

TYPICAL PERFORMANCE CHARACTERISTICS (T_A = 25°C)

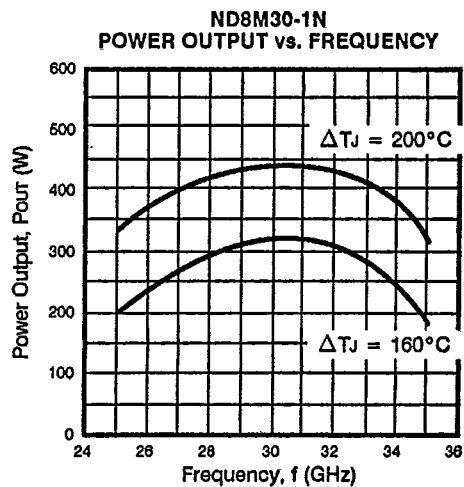
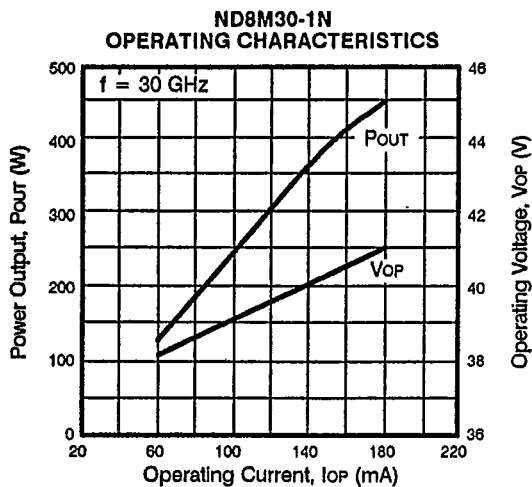
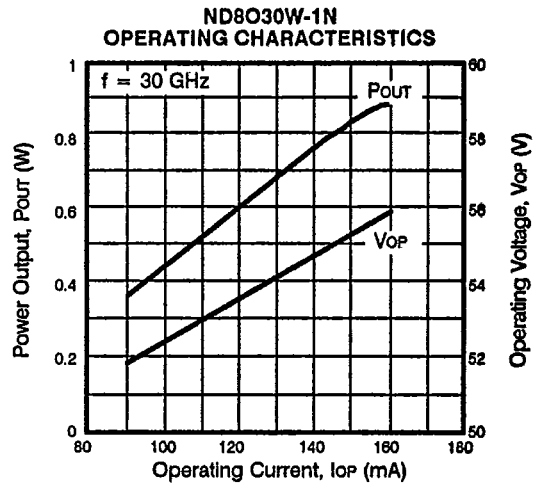
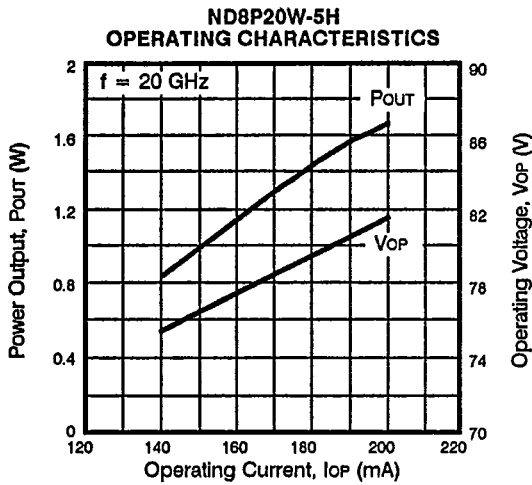
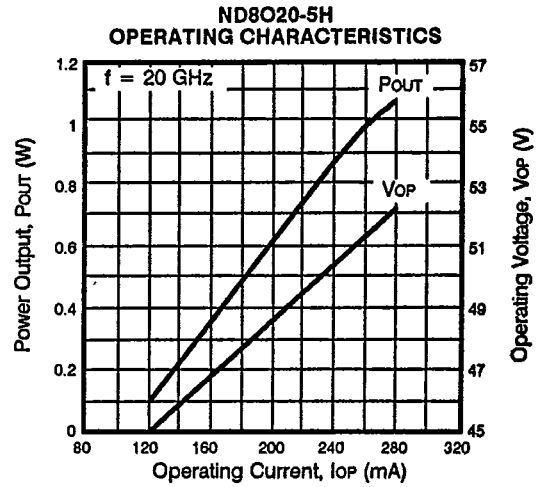
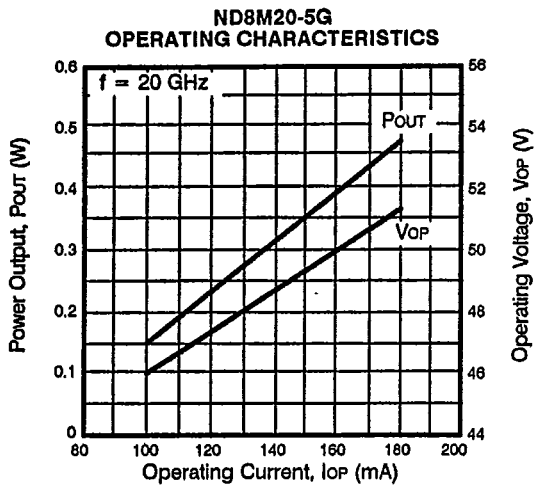

TYPICAL PERFORMANCE CHARACTERISTICS ($T_A = 25^\circ\text{C}$)

**ND8N40W-1N
OPERATING CHARACTERISTICS**

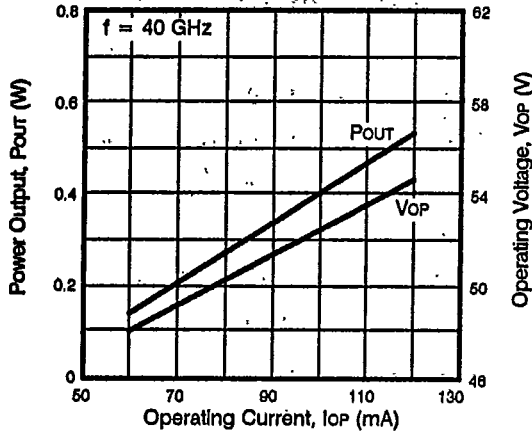

**ND8L60W-1T
OPERATING CHARACTERISTICS**

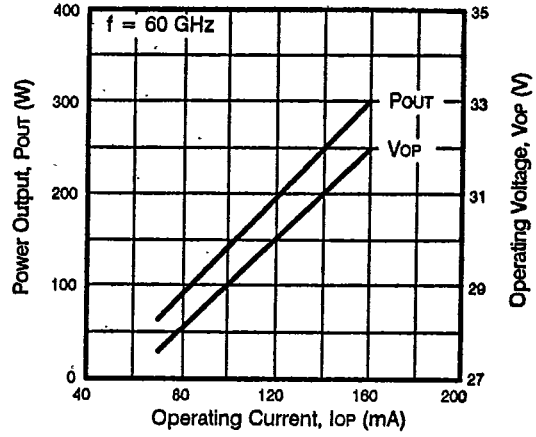

**ND8J80W-1T
OPERATING CHARACTERISTICS**

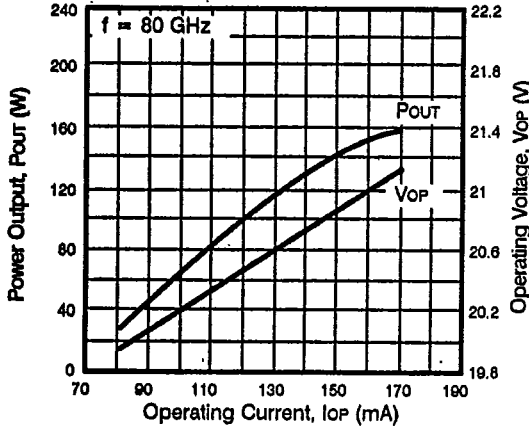

**ND8G96W-1T
OPERATING CHARACTERISTICS**

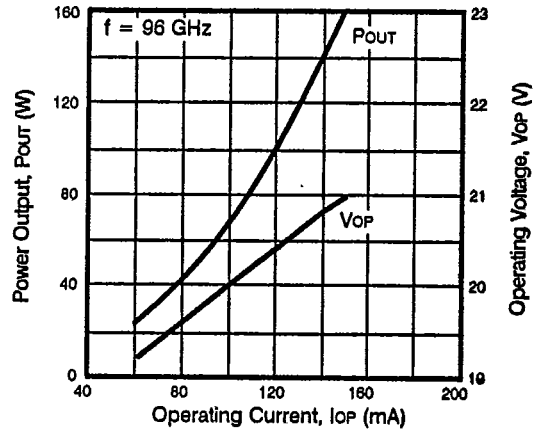

CW IMPATT SELECTION GRAPH

