



**CD4071BM/CD4071BC**  
**Quad 2-Input OR Buffered B Series Gate**  
**CD4081BM/CD4081BC**  
**Quad 2-Input AND Buffered B Series Gate**

**General Description**

These quad gates are monolithic complementary MOS (CMOS) integrated circuits constructed with N- and P-channel enhancement mode transistors. They have equal source and sink current capabilities and conform to standard B series output drive. The devices also have buffered outputs which improve transfer characteristics by providing very high gain.

All inputs protected against static discharge with diodes to  $V_{DD}$  and  $V_{SS}$ .

**Features**

- Low power TTL compatibility
- 5V-10V-15V parametric ratings
- Symmetrical output characteristics
- Maximum input leakage  $1 \mu A$  at 15V over full temperature range

Fan out of 2 driving 74L or 1 driving 74LS

**Connection Diagrams**

**CD4071B Dual-In-Line Package**

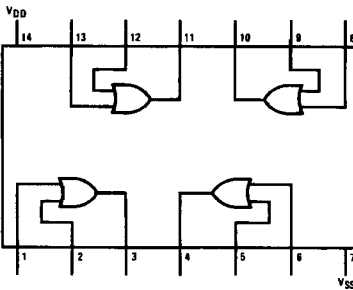

**Top View**

TL/F/5977-3

**CD4081B Dual-In-Line Package**

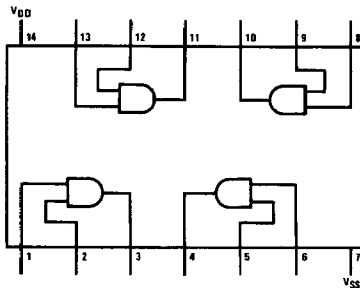

**Top View**

TL/F/5977-6

**Order Number CD4071B\* or CD4081B\***

\*Please look into Section 8, Appendix D for availability of various package types.

### Absolute Maximum Ratings (Notes 1 & 2)

If Military/Aerospace specified devices are required, contact the National Semiconductor Sales Office/Distributors for availability and specifications.

Voltage at Any Pin	-0.5V to $V_{DD} + 0.5V$
Power Dissipation ( $P_D$ )	
Dual-In-Line	700 mW
Small Outline	500 mW
$V_{DD}$ Range	-0.5 $V_{DC}$ to +18 $V_{DC}$
Storage Temperature ( $T_S$ )	-65°C to +150°C

Lead Temperature ( $T_L$ )  
(Soldering, 10 seconds)

260°C

### Operating Conditions

Operating Range ( $V_{DD}$ )	3 $V_{DC}$ to 15 $V_{DC}$
Operating Temperature Range ( $T_A$ )	
CD4071BM, CD4081BM	-55°C to +125°C
CD4071BC, CD4081BC	-40°C to +85°C

### DC Electrical Characteristics CD4071BM/CD4081BM (Note 2)

Symbol	Parameter	Conditions	-55°C		+25°C			+125°C		Units
			Min	Max	Min	Typ	Max	Min	Max	
$I_{DD}$	Quiescent Device Current	$V_{DD} = 5V$		0.25		0.004	0.25		7.5	$\mu A$
		$V_{DD} = 10V$		0.50		0.005	0.50		15	$\mu A$
		$V_{DD} = 15V$		1.0		0.006	1.0		30	$\mu A$
$V_{OL}$	Low Level Output Voltage	$V_{DD} = 5V$	$ I_{OL}  < 1 \mu A$	0.05		0	0.05		0.05	V
		$V_{DD} = 10V$		0.05		0	0.05		0.05	V
		$V_{DD} = 15V$		0.05		0	0.05		0.05	V
$V_{OH}$	High Level Output Voltage	$V_{DD} = 5V$	$ I_{OL}  < 1 \mu A$	4.95		4.95	5		4.95	V
		$V_{DD} = 10V$		9.95		9.95	10		9.95	V
		$V_{DD} = 15V$		14.95		14.95	15		14.95	V
$V_{IL}$	Low Level Input Voltage	$V_{DD} = 5V, V_O = 0.5V$		1.5		2	1.5		1.5	V
		$V_{DD} = 10V, V_O = 1.0V$		3.0		4	3.0		3.0	V
		$V_{DD} = 15V, V_O = 1.5V$		4.0		6	4.0		4.0	V
$V_{IH}$	High Level Input Voltage	$V_{DD} = 5V, V_O = 4.5V$		3.5		3.5	3		3.5	V
		$V_{DD} = 10V, V_O = 9.0V$		7.0		7.0	6		7.0	V
		$V_{DD} = 15V, V_O = 13.5V$		11.0		11.0	9		11.0	V
$I_{OL}$	Low Level Output Current (Note 3)	$V_{DD} = 5V, V_O = 0.4V$		0.64		0.51	0.88		0.36	mA
		$V_{DD} = 10V, V_O = 0.5V$		1.6		1.3	2.25		0.9	mA
		$V_{DD} = 15V, V_O = 1.5V$		4.2		3.4	8.8		2.4	mA
$I_{OH}$	High Level Output Current (Note 3)	$V_{DD} = 5V, V_O = 4.6V$	-0.64		-0.51	-0.88		-0.36		mA
		$V_{DD} = 10V, V_O = 9.5V$	-1.6		-1.3	-2.25		-0.9		mA
		$V_{DD} = 15V, V_O = 13.5V$	-4.2		-3.4	-8.8		-2.4		mA
$I_{IN}$	Input Current	$V_{DD} = 15V, V_{IN} = 0V$		-0.10		$-10^{-5}$	-0.10		-1.0	$\mu A$
		$V_{DD} = 15V, V_{IN} = 15V$		0.10		$10^{-5}$	0.10		1.0	$\mu A$

**Note 1:** "Absolute Maximum Ratings" are those values beyond which the safety of the device cannot be guaranteed. Except for "Operating Temperature Range" they are not meant to imply that the devices should be operated at these limits. The table of "Electrical Characteristics" provides conditions for actual device operation.

**Note 2:** All voltages measured with respect to  $V_{SS}$  unless otherwise specified.

**Note 3:**  $I_{OH}$  and  $I_{OL}$  are tested one output at a time.

## DC Electrical Characteristics CD4071BC/CD4081BC (Note 2)

Symbol	Parameter	Conditions	-40°C		+25°C			+85°C		Units
			Min	Max	Min	Typ	Max	Min	Max	
I <sub>DD</sub>	Quiescent Device Current	V <sub>DD</sub> = 5V		1		0.004	1		7.5	μA
		V <sub>DD</sub> = 10V		2		0.005	2		15	μA
		V <sub>DD</sub> = 15V		4		0.006	4		30	μA
V <sub>OL</sub>	Low Level Output Voltage	V <sub>DD</sub> = 5V	I <sub>O</sub>   < 1 μA	0.05		0	0.05		0.05	V
		V <sub>DD</sub> = 10V		0.05		0	0.05		0.05	V
		V <sub>DD</sub> = 15V		0.05		0	0.05		0.05	V
V <sub>OH</sub>	High Level Output Voltage	V <sub>DD</sub> = 5V	I <sub>O</sub>   < 1 μA	4.95		4.95	5		4.95	V
		V <sub>DD</sub> = 10V		9.95		9.95	10		9.95	V
		V <sub>DD</sub> = 15V		14.95		14.95	15		14.95	V
V <sub>IL</sub>	Low Level Input Voltage	V <sub>DD</sub> = 5V, V <sub>O</sub> = 0.5V		1.5		2	1.5		1.5	V
		V <sub>DD</sub> = 10V, V <sub>O</sub> = 1.0V		3.0		4	3.0		3.0	V
		V <sub>DD</sub> = 15V, V <sub>O</sub> = 1.5V		4.0		6	4.0		4.0	V
V <sub>IH</sub>	High Level Input Voltage	V <sub>DD</sub> = 5V, V <sub>O</sub> = 4.5V	3.5		3.5	3		3.5		V
		V <sub>DD</sub> = 10V, V <sub>O</sub> = 9.0V	7.0		7.0	6		7.0		V
		V <sub>DD</sub> = 15V, V <sub>O</sub> = 13.5V	11.0		11.0	9		11.0		V
I <sub>OL</sub>	Low Level Output Current (Note 3)	V <sub>DD</sub> = 5V, V <sub>O</sub> = 0.4V	0.52		0.44	0.88		0.36		mA
		V <sub>DD</sub> = 10V, V <sub>O</sub> = 0.5V	1.3		1.1	2.25		0.9		mA
		V <sub>DD</sub> = 15V, V <sub>O</sub> = 1.5V	3.6		3.0	8.8		2.4		mA
I <sub>OH</sub>	High Level Output Current (Note 3)	V <sub>DD</sub> = 5V, V <sub>O</sub> = 4.6V	-0.52		-0.44	-0.88		-0.36		mA
		V <sub>DD</sub> = 10V, V <sub>O</sub> = 9.5V	-1.3		-1.1	-2.25		-0.9		mA
		V <sub>DD</sub> = 15V, V <sub>O</sub> = 13.5V	-3.6		-3.0	-8.8		-2.4		mA
I <sub>IN</sub>	Input Current	V <sub>DD</sub> = 15V, V <sub>IN</sub> = 0V		-0.30		-10 <sup>-5</sup>	-0.30		-1.0	μA
		V <sub>DD</sub> = 15V, V <sub>IN</sub> = 15V		0.30		10 <sup>-5</sup>	0.30		1.0	μA

## AC Electrical Characteristics\* CD4071BC/CD4071BM

T<sub>A</sub> = 25°C, Input t<sub>r</sub>, t<sub>f</sub> = 20 ns, C<sub>L</sub> = 50 pF, R<sub>L</sub> = 200 kΩ, Typical temperature coefficient is 0.3%/°C

Symbol	Parameter	Conditions	Typ	Max	Units
t <sub>PHL</sub>	Propagation Delay Time, High-to-Low Level	V <sub>DD</sub> = 5V	100	250	ns
		V <sub>DD</sub> = 10V	40	100	ns
		V <sub>DD</sub> = 15V	30	70	ns
t <sub>PLH</sub>	Propagation Delay Time, Low-to-High Level	V <sub>DD</sub> = 5V	90	250	ns
		V <sub>DD</sub> = 10V	40	100	ns
		V <sub>DD</sub> = 15V	30	70	ns
t <sub>THL</sub> , t <sub>TLH</sub>	Transition Time	V <sub>DD</sub> = 5V	90	200	ns
		V <sub>DD</sub> = 10V	50	100	ns
		V <sub>DD</sub> = 15V	40	80	ns
C <sub>IN</sub>	Average Input Capacitance	Any Input	5	7.5	pF
C <sub>PD</sub>	Power Dissipation Capacity	Any Gate	18		pF

\*AC Parameters are guaranteed by DC correlated testing.

**Note 1:** "Absolute Maximum Ratings" are those values beyond which the safety of the device cannot be guaranteed. Except for "Operating Temperature Range" they are not meant to imply that the devices should be operated at these limits. The table of "Electrical Characteristics" provides conditions for actual device operation.

**Note 2:** All voltages measured with respect to V<sub>SS</sub> unless otherwise specified.

**Note 3:** I<sub>OH</sub> and I<sub>OL</sub> are tested one output at a time.

**AC Electrical Characteristics\*** CD4081BC/CD4081BM

$T_A = 25^\circ\text{C}$ , Input  $t_r = t_f = 20\text{ ns}$ ,  $C_L = 50\text{ pF}$ ,  $R_L = 200\text{ k}\Omega$ , Typical temperature coefficient is  $0.3\%/^\circ\text{C}$

Symbol	Parameter	Conditions	Typ	Max	Units
$t_{PHL}$	Propagation Delay Time, High-to-Low Level	$V_{DD} = 5\text{V}$	100	250	ns
		$V_{DD} = 10\text{V}$	40	100	ns
		$V_{DD} = 15\text{V}$	30	70	ns
$t_{PLH}$	Propagation Delay Time, Low-to-High Level	$V_{DD} = 5\text{V}$	120	250	ns
		$V_{DD} = 10\text{V}$	50	100	ns
		$V_{DD} = 15\text{V}$	35	70	ns
$t_{THL}, t_{TLH}$	Transition Time	$V_{DD} = 5\text{V}$	90	200	ns
		$V_{DD} = 10\text{V}$	50	100	ns
		$V_{DD} = 15\text{V}$	40	80	ns
$C_{IN}$	Average Input Capacitance	Any Input	5	7.5	pF
$C_{PD}$	Power Dissipation Capacity	Any Gate	18		pF

\*AC Parameters are guaranteed by DC correlated testing.

**Typical Performance Characteristics**

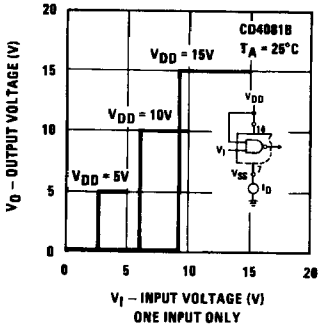

TL/F/5977-7

**FIGURE 1. Typical Transfer Characteristics**

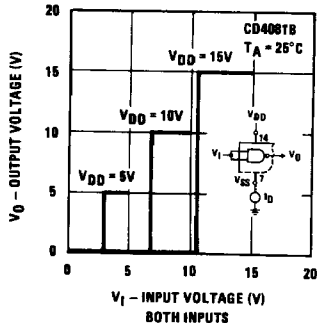

TL/F/5977-8

**FIGURE 2. Typical Transfer Characteristics**

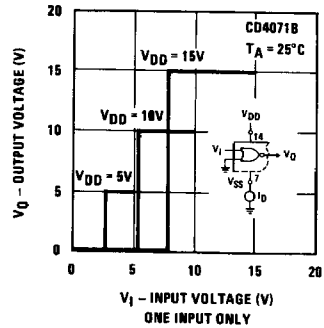

TL/F/5977-9

**FIGURE 3. Typical Transfer Characteristics**

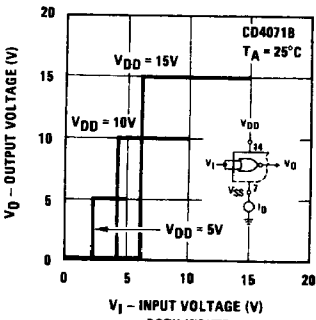

TL/F/5977-10

**FIGURE 4. Typical Transfer Characteristics**

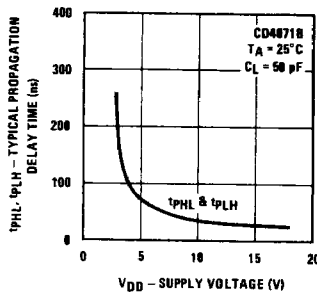

TL/F/5977-11

**FIGURE 5**

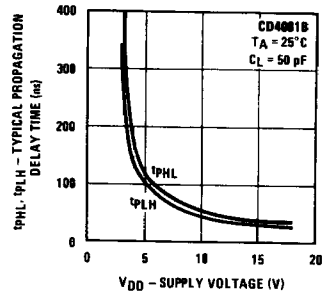

TL/F/5977-12

**FIGURE 6**

Typical Performance Characteristics (Continued)

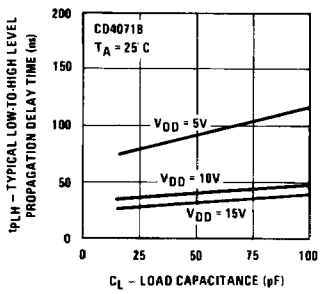

FIGURE 7

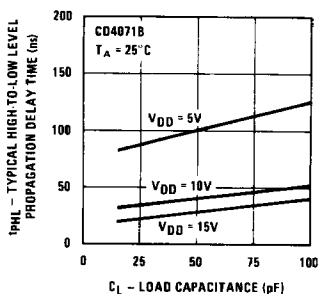

FIGURE 8

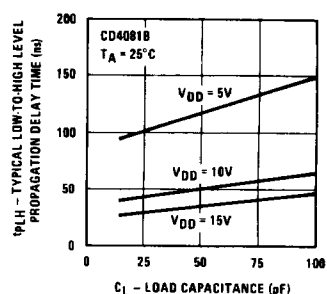

FIGURE 9

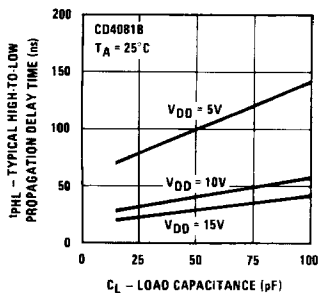

FIGURE 10

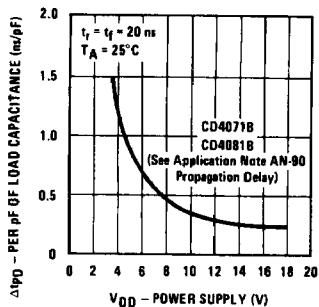

FIGURE 11

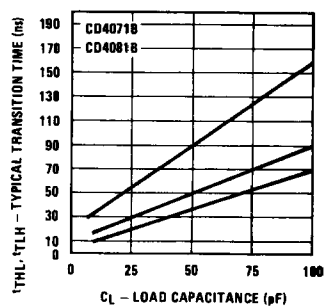

FIGURE 12

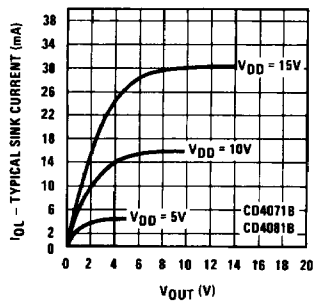

FIGURE 13

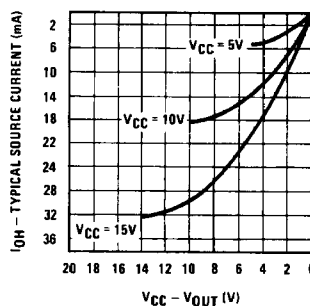
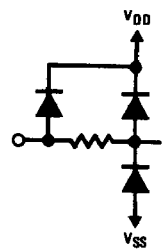
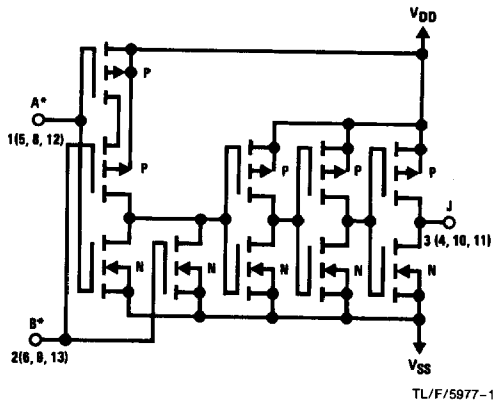

FIGURE 14

Schematic Diagrams

CD4071B



¼ of device shown

$J = A + B$

Logical "1" = High

Logical "0" = Low

\*All inputs protected by standard CMOS protection circuit.

CD4081B

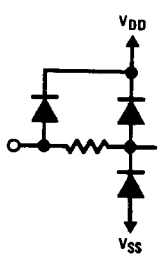
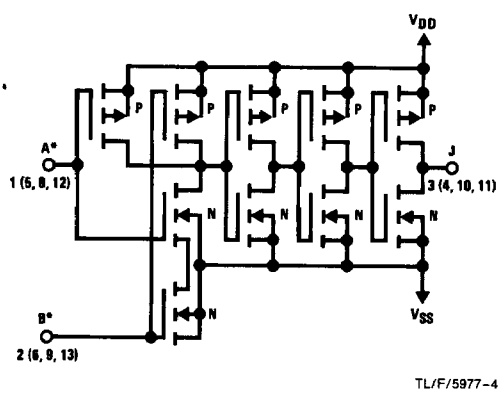

¼ of device shown

$J = A \cdot B$

Logical "1" = High

Logical "0" = Low

\*All inputs protected by standard CMOS protection circuit.