

74LS1801 Bit Stream Manager

Encoder/Decoder
Product Specification

Logic Products

DESCRIPTION

The 74LS1801 Encoder/Decoder (Figure 1) supports disk drive and data communications devices that require fast and reliable data separation capabilities. Although ideally suited for use with the 74LS1802 Serializer/Deserializer, the 74LS1801 is a flexible device which can be implemented in a variety of design applications.

Encoding is possible in FM, MFM, or Differential Manchester formats, making the 74LS1801 invaluable in designs requiring single density disk recording, double density disk recording, or in data communications applications. Included on-chip is a phase-comparator which can be bypassed; this feature is particularly useful in applications that use a complete external phase lock loop.

FEATURES

- Data rates up to 10MHz
- FM, MFM, and Differential Manchester encoding/decoding
- Precompensation in MFM write mode
- Built-in phase comparator
- Single 5-volt power supply
- Selectable encoding violation generation/detection formats

PIN CONFIGURATION

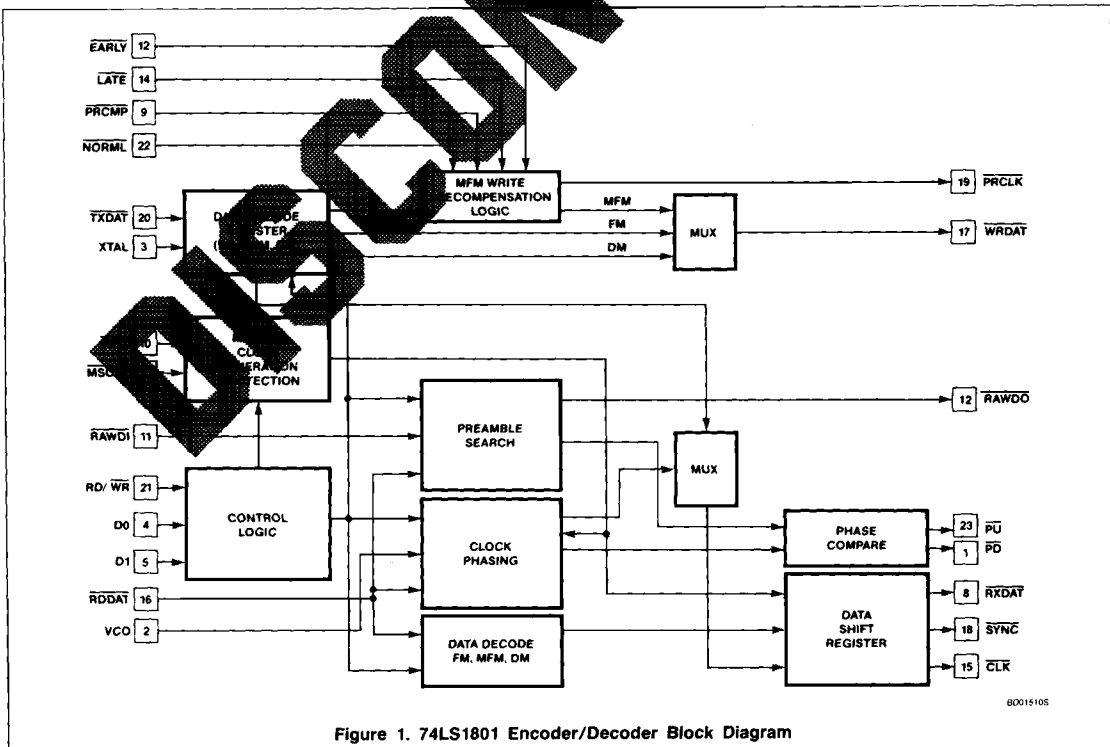
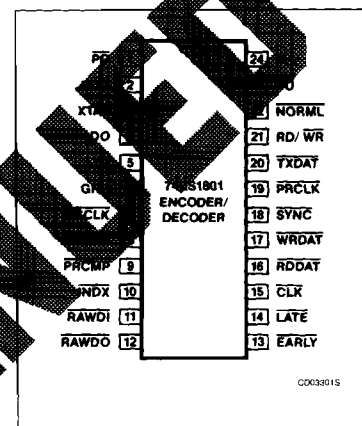
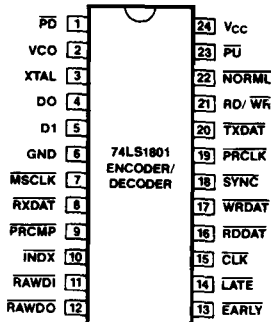

Figure 1. 74LS1801 Encoder/Decoder Block Diagram

Bit Stream Manager

74LS1801

PIN DESCRIPTION



PIN NO.	IDENTIFIER	DESCRIPTION
10	INDX	INDeX – an input that designates the missing clock pattern to be generated during the write mode; in the read mode, determines which data/clock pattern must be recognized as an add (see Table 2, 3).
11	RAWDI	RAW Data In – an input data signal derived from RAWDI. It is internally tied directly to RAWDI.
12	RAWDO	RAW Data Out – a shaped data pulse derived from RAWDI that can be processed through an external phase lock loop. RAWDO is internally tied directly to RAWDI.
13	EARLY	EARLY – defines clock rate with respect to crystal resonance when an early precompensation is desired.
14	LATE	LATE – defines clock rate with respect to crystal resonance when late pre-compensation is desired.
15	CLK	CLoCK – Clock input equal to the frequency of NRZ data.
16	RDDAT	ReaD DATA – an input of encoded serial data (MFM, FM, or Differential Manchester) that is to be converted to NRZ data.
17	WRDAT	WRite DATA – an output of encoded serial data (FM, MFM, or Differential Manchester) derived from NRZ data.
18	SYNC	SYNChronization output – when active low, indicates recognition of valid encoding violation in the RDDAT.
19	PRCLK	PReCompensation CLoCK – an output used to excite an external delay line.
20	TXDAT	TranSMit Data – an input of NRZ data that is to be encoded to FM, MFM, or Differential Manchester data.
21	RD/WR	ReaD/WRite – an input designating mode of operation: when high, a read is indicated; when low, a write is indicated.
22	NORML	NORMaL – a clock input that is used when no precompensation is desired.
23	PU	Pump UP – an output from the phase comparator that indicates the frequency of an external VCO is too low as compared to RDDAT.
24	VCC	Supply voltage.

7

Bit Stream Manager

74LS1801

FUNCTIONAL OPERATION

The 74LS1801 Encoder/Decoder serves to translate data between disk drive or data communications devices and the 74LS1802 Serializer/Deserializer (or comparable device). Information entering or leaving the Serializer/Deserializer interface is in the form of standard NRZ data and can be encoded to (or decoded from) one of three popular formats:

- Frequency Modulation (FM) — single density disk recordings.
- Modified Frequency Modulation (MFM) — double density disk recordings.
- Differential Manchester — data communications applications.

Read/Write and Format Control

The operational mode of the 74LS1801 is dictated by the RD/WR input: when low, a write (encode) is indicated; when high, a read (decode) is designated. In either mode, the format of data being decoded or encoded is controlled by the states of D0 and D1 inputs as shown below:

Table 1. Format Control

D0	D1	RESULTING FORMAT
L	L	MFM
H	L	FM
L	H	Differential Manchester

Following are discussions of the encoding and decoding functions of the 74LS1801 and the timing requirements necessary for accurate data transmittal.

Encoding Logic

When in the encode mode, the data input via the TXDAT input and after a one bit delay, is output on the RXDAT output. The output format is dependent on the states of D0 and D1. Address marks are generated from data by encoding the output within the character.

These "missing clocks" are generated within the byte following a preamble of either all 0's (MFM and FM format) or all 1's (Differential Manchester format). As described in Table 2, clocks are eliminated according to inputs IND_X, MSCLK, and the specified encoding format.

When encoding data in the MFM format, MSCLK may be enabled during preamble generation and up to the beginning of an address mark. MSCLK can then be disabled during the byte following an address mark, or before the final bit of a four bit series in which the first two bits are 0's (e.g., before the final 0 in 0010). In applications utilizing consecutive A1 characters (such as in the case of floppy disk soft-sectored formats), MSCLK

Table 2. Missing Clocks

MSCLK	IND _X	FORMAT	RESULTING CLOCK PATTERN							
			Bit Cell Numbers:							
			0	1	2	3	4	5	6	7
L	H	FM			V	V	V			
L	L	FM			V	V	V			
L	H	Differential Manchester	V	V		V	V			
L	L	Differential Manchester	V	V						
L	X	MFM	2nd of 3 bits missing							

NOTES:
X = Don't care
V = Missing Clock

Table 3. Address Mark Identification in Decode Mode

MSCLK	IND _X	ACTIVE SYNC OUTPUT
H	X	First "1" bit after preamble
L	H	Byte with missing clocks
L	L	Byte with missing clocks

would remain active until the beginning of the next data byte. The conditions are described below and summarized in Table 3.

The 74LS1801 provides phase compensation capabilities when encoding data in the MFM format via the PRCLK signal (low) synchronizing the output according to a clock provided on any of the three inputs: EN — a clock provided early in time, D — a clock provided late in time, or NRZ — a clock provided when no precompensation is provided. These inputs are supplied by an internal delay line which, in turn, is excited by the PRCLK output (see Typical System Configuration, Figure 2.)

When encoding in FM or Differential Manchester formats, missing clocks are only generated in the first byte following a preamble of zeroes. The most significant bit of this byte must be a "1"; for example, address marks F8, FB, FC, or FE. MSCLK may be enabled up to the beginning of an address mark; once an address mark has been transmitted, it is not necessary to disable MSCLK.

Decoding Logic

In the decode mode, data (MFM, FM, or Differential Manchester) is input via the RDDAT input and, after an eleven bit delay, is output as NRZ data on RXDAT. As described above, input format is defined by the states of D0 and D1. In the MFM format, a minimum preamble length of 34 bits is required to allow for phase synchronization and location of an address mark; when in FM or Differential Manchester mode, a minimum length of 18 bits is required. After a preamble has been recognized, the 74LS1801 searches for an address mark. When an address mark is identified, the SYNC output becomes active low, and alerts the 74LS1802 of incoming data. Rules for positive address mark identification

When MSCLK is inactive, SYNC is activated on the first "1" data bit following a preamble of zeroes (MFM and FM) or 1's (Differential Manchester). Data is contained in the byte following this bit.

If MSCLK is active, the byte following a preamble of all zeroes is checked for the required missing clocks (Table 3) and if detected, SYNC is activated.

PHASE LOCK LOOP AND DATA SEPARATION LOGIC

Data/clock separation logic requires a clock pulse that is synchronous with read data (RDDAT); to create this signal, the 74LS1801 employs a Phase Lock Loop. In its simplest form, the PLL consists of an internal phase comparator, an external low pass filter and an external voltage controlled oscillator (VCO). Output from the VCO is continuously fed back to the phase compare circuit and contrasted with data read from the disk or communications device (RDDAT). A difference in phase is represented as one of two quantized output pulses: Pump Up indicates VCO frequency is too low, whereas Pump Down indicates that the VCO frequency is too high. The resulting output (P_U or P_D) is then processed by a low-pass filter which outputs a DC voltage proportional to the phase deviation. Accordingly, the VCO frequency is precisely serviced to the rate at which data was recorded. The 74LS1801 provides the capability to bypass internal phase compare logic; a typical application of this feature would be in designs implementing a complete external PLL.

Bit Stream Manager

74LS1801

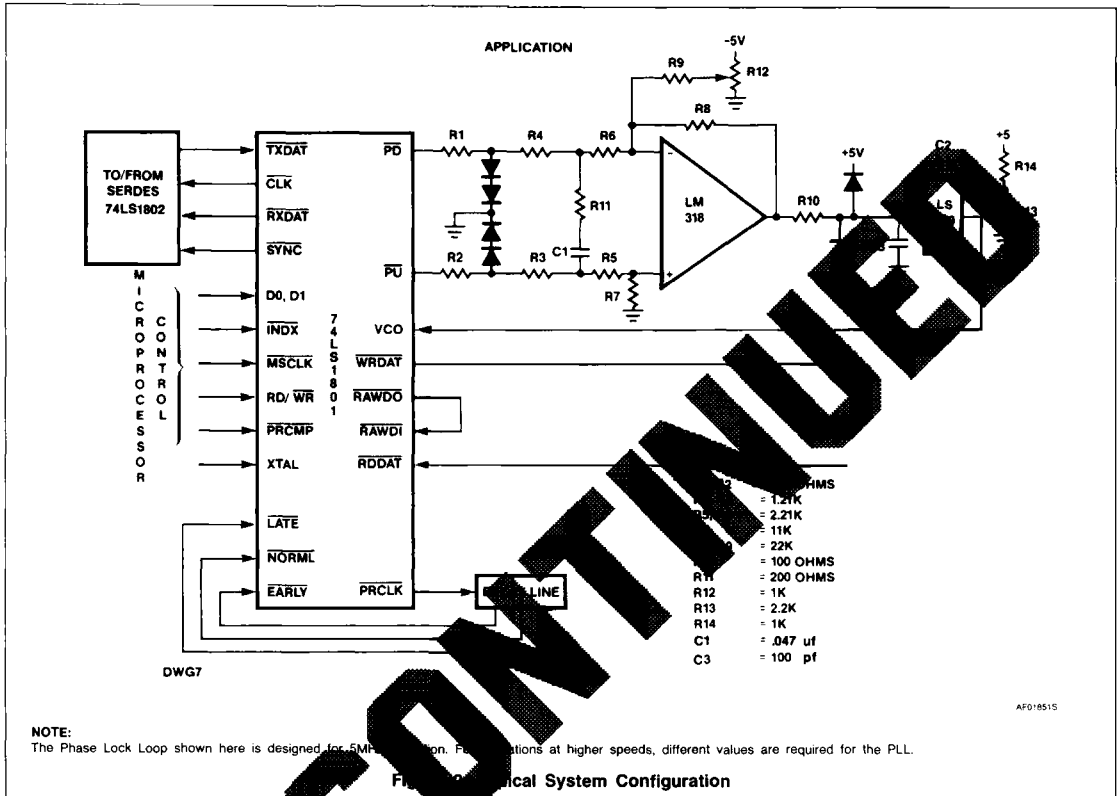
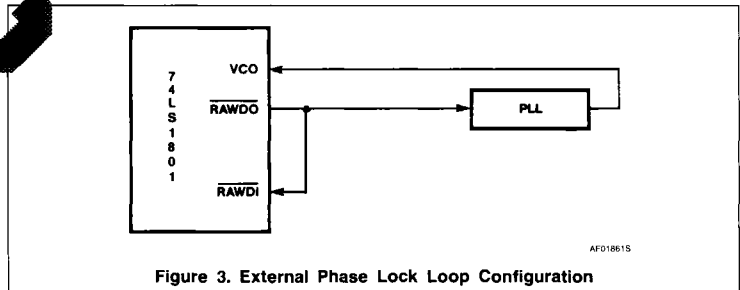

Figure 3 illustrates this application as discussed below.

RAW Data Out is a shaped data pulse derived directly from RDDAT. When the rising edge of RDDAT is generated, the falling edge of RDDAT is present from the rising and falling edges of RAWDO. In the shaped data pulse derived from RAWDO and is used in internal data synchronization logic. The falling edge of RAWDO is in phase with the falling edge of the RAWDI is normally tied directly to RAWDO.



Bit Stream Manager

74LS1801

CLOCK CYCLE

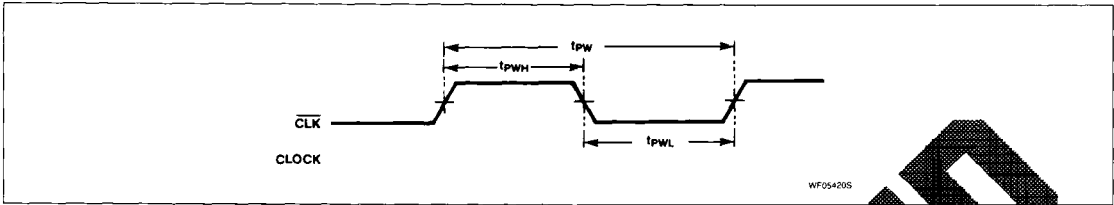

READ CYCLE

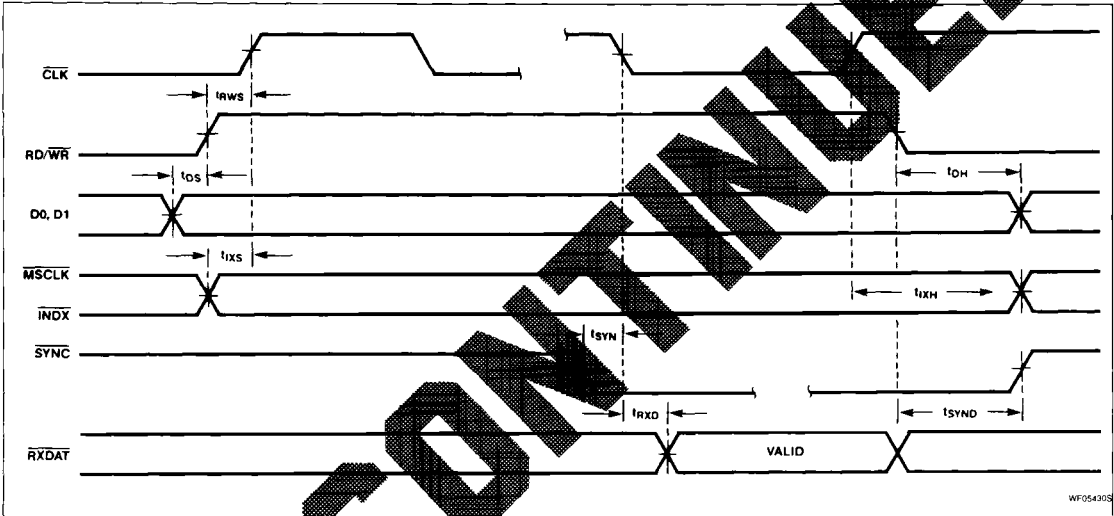

OTHER TIMING

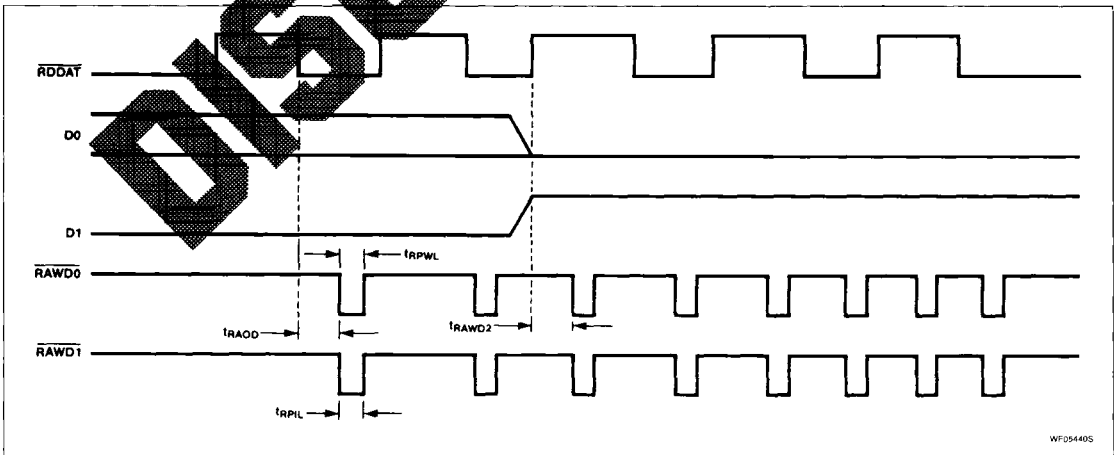

Bit Stream Manager

74LS1801

WRITE CYCLE TIMING

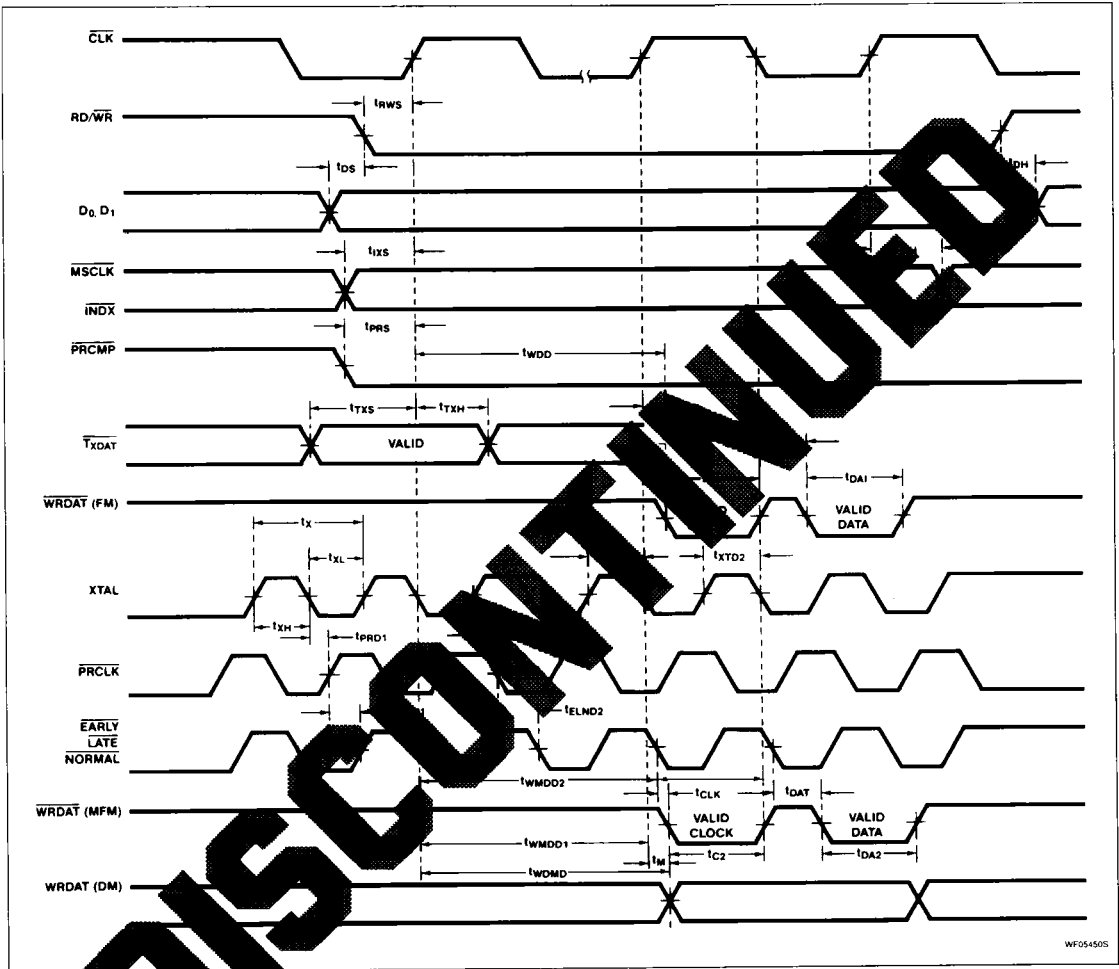

DISCONTINUED

Bit Stream Manager

74LS1801

ABSOLUTE MAXIMUM RATINGS

PIN	DESCRIPTION	RATING	UNIT
V _{CC}	Supply voltage	+7.0	V
All other pins	Logic input pins	5.5	V

DC ELECTRICAL CHARACTERISTICS V_{CC} = 5V±5%; TA = 0°C to +70°C

PARAMETER	TEST CONDITIONS	LIMITS			UNIT	REMARKS
		Min	Typ	Max		
V _{TH}	Input threshold voltage	0.8		2.0	V	
V _{CD}	Input clamp diode voltage	I _N = -18mA		-1.2	V	
I _{IL}	Input low current	V _{IN} = 0.4V			μA	
I _{IH}	Input high current	V _{IN} = 2.7V			μA	
I _I	Max input high current	V _{IN} = 5.5V		1.0	μA	
V _{OL}	Output voltage low	I _{OL} = 8mA			V	Pins 8, 12, 15, 17, 18, 19 Pins 1, 23
		I _{OL} = 20mA		0.5	V	
V _{OH}	Output voltage high	V _{CC} = 4.5V			V	Pins 8, 12, 15, 17, 18, 19 Pins 1, 23
		I _{OH} = 400μA			V	
I _{OS}	Output short circuit current	V _{out} = 0V	5		mA	Pins 8, 12, 15, 17, 18, 19 Pins 1, 23
		V _{out} = V _{CC}			mA	
I _{CC}	Supply current			184	mA	

AC ELECTRICAL CHARACTERISTICS

PARAMETER	DESCRIPTION	LIMITS (in ns)		
		Min	Typ	Max
t _{PW}	CLK pulse width	100		
t _{PWL}	CLK pulse width low	50		
t _{PWH}	CLK pulse width high	50		
t _X	CLK cycle time	50		
t _{XH}	XT _H high time	25		
t _{XL}	XT _L low time	25		
t _{RWS}	RD/WR set-up to ↑CLK	0		
t _{DS}	D0, D1 set-up to RD/WR	0		
t _{XS}	MSCLK, IND _X set-up to ↑CLK		35.2	
t _{SYN}	↓SYNC to ↓CLK	2		
t _{RXD}	↓CLK to RXDAT valid			4
t _{DH}	RD/WR to D0, D1 hold	0		
t _{SYND}	RD/WR to SYNC inactive delay			36.4
t _{RAOD}	↓RDDAT to ↓RAWDO delay		29.2	
t _{RPIL}	RAWDI pulse width	20*		
t _{RPWL}	RAWDO pulse width			40*
t _{WDMD}	TXDAT to WRDAT (DM)			t _{PW} + 41.2
t _M	↑CLK to WRDAT delay		41.2	
t _{RAWO2}	↑RDDAT to ↓RAWDO delay		32.2	

Bit Stream Manager

74LS1801

AC ELECTRICAL CHARACTERISTICS (Continued)

PARAMETER	DESCRIPTION	LIMITS (in ns)		
		Min	Typ	Max
t _{DA2}	DATA bit duration		23.0	
t _{XH}	↑CLK to $\overline{\text{MSCLK}}$, $\overline{\text{INDX}}$ hold		19.0	
t _{PRS}	$\overline{\text{PRCMP}}$ set-up to ↑CLK		19.0	0
t _{XS}	$\overline{\text{TXDAT}}$ set-up to ↑CLK		19.0	
t _{XH}	$\overline{\text{TXDAT}}$ hold time		19.0	
t _{WDD}	$\overline{\text{TXDAT}}$ to $\overline{\text{WRDAT}}$ clock delay (FM data)		tpw + 19.0	
t _D	↑CLK to clock delay (FM data)		36.3	
t _{C1}	Clock bit duration (FM)		19.0	
t _{R1}	Clock & data bit separation		19.0	
t _{DA1}	Data bit duration (FM)		19.0	
t _{XTD1}	↑XTAL to ↑CLK delay		35.2	
t _{XTD2}	↑XTAL to ↓CLK delay		32.2	
t _{PRD1}	↓XTAL to ↑PRCLK delay		26.3	
t _{PRD2}	↑XTAL to ↓PRCLK delay		28.3	
t _{ELND1}	↑PRCLK to <u>Early, Late, Normal</u> rising edge	tpw		1/4 tpw
t _{ELND2}	↓PRCLK to <u>Early, Late, Normal</u> falling edge	1/4 tpw		0
t _{WMDD2}	$\overline{\text{TXDAT}}$ to $\overline{\text{WRDAT}}$ data delay (MFM)			3.5 x tpw
t _{WMDD1}	$\overline{\text{TXDAT}}$ to $\overline{\text{WRDAT}}$ clock delay (MFM)			3.0 x tpw
t _{CLK}	<u>Early, Late, Normal</u> falling edge to clock delay (FM)		12.1	
t _{C2}	Clock bit duration (MFM)		23.0	
t _{DAT}	<u>Early, Late, Normal</u> falling edge to data delay (MFM)		12.1	

*Tabular entries with an asterisk are parameters that are guaranteed. These values were determined either by system bench testing or by Signetics' characterization procedures. All other tabular entries are taken directly from test results run at range of operational frequencies; these values are not tested or guaranteed.

DISCONTINUED