

RoHS compliant

2.5mm (.098") Pitch Housing

YAK E182481

Features:

- * Available in 2 through 16 Circuits
- * Material: Nylon 66 UL94V-0
- * Accepts YY-1000A-T Crimp Terminal

Specifications:

- * Pitch between Poles 2.5mm
- * Rated Voltage 250V AC,DC
- * Rated Current 3A
- * Withstand Voltage 800V AC/minute
- * Insulation Resistance 1,000M Ohms/min
- * Temperature Range -25°C~+85°C

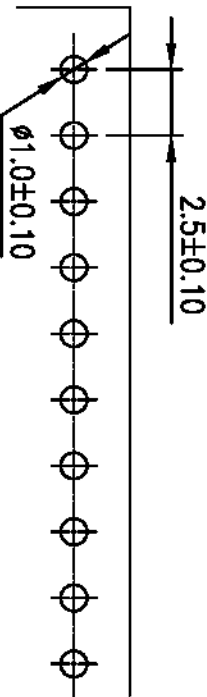
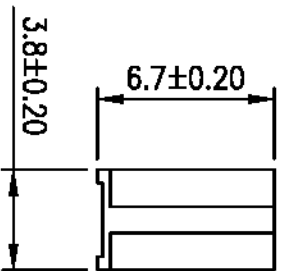
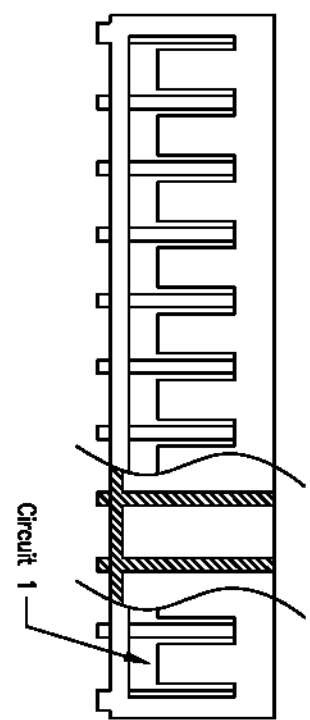
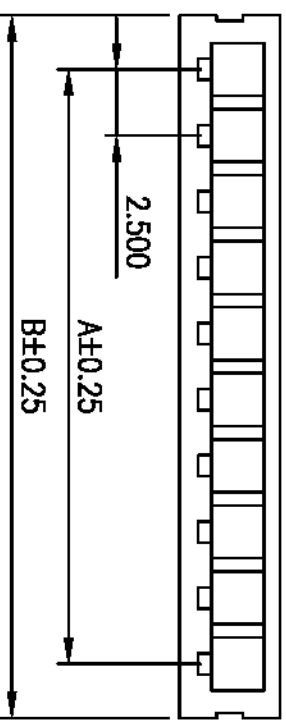

P.C.B LAYOUT

Circuits	Part No	Dimension mm	
		A	B
2	YY-1000A-H02	2.50	6.60
3	YY-1000A-H03	5.00	9.10
4	YY-1000A-H04	7.50	11.60
5	YY-1000A-H05	10.00	14.10
6	YY-1000A-H06	12.50	16.60
7	YY-1000A-H07	15.00	19.10
8	YY-1000A-H08	17.50	21.60
9	YY-1000A-H09	20.00	24.10
10	YY-1000A-H10	22.50	26.60
11	YY-1000A-H11	25.00	29.10
12	YY-1000A-H12	27.50	31.60
13	YY-1000A-H13	30.00	34.10
14	YY-1000A-H14	32.50	36.60
15	YY-1000A-H15	35.00	39.10
16	YY-1000A-H16	37.50	41.60

EDITION	DATE	MODIFY	VIEW	DRAW BY	AUDITING	APPROVAL	DATE	DWG NO	TOLERANCE
A0	2002.08.05	DRAWING		Turnng Sun	ALVIN	Jessica	2002.08.05	YY-1000A-HXX	.00 ±0.15 .000 ±0.05

YAK 毅耀實業股份有限公司
YOUNG YAK ENTERPRISE CO.,LTD.

TEL:886-2-2999-9629
FAX:886-2-2999-0575

RoHS compliant

2.5mm (.098") Pitch Housing

Y Y E182481

Features:

- * Available in 2 through 16 Circuits
- * Material: Nylon 66 UL94V-0
- * Accepts YY-1000A-T Crimp Terminal

Specifications:

- * Pitch between Poles 2.5mm
- * Rated Voltage 250V AC,DC
- * Rated Current 3A
- * Withstand Voltage 800V AC/minute
- * Insulation Resistance 1,000M Ohms/min
- * Temperature Range -25°C~+85°C

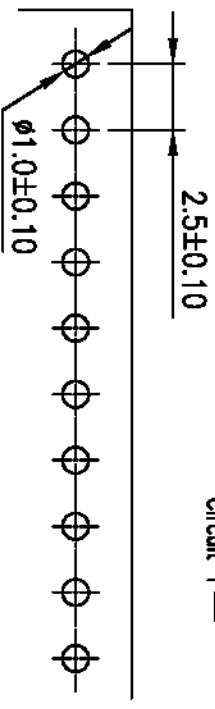
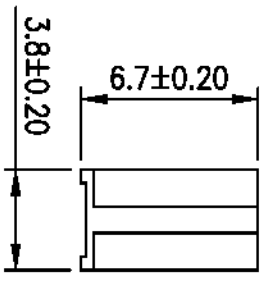
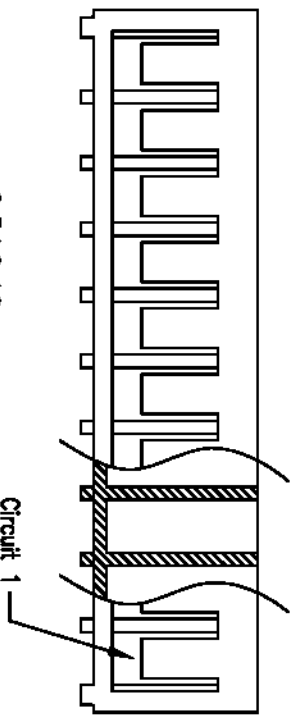
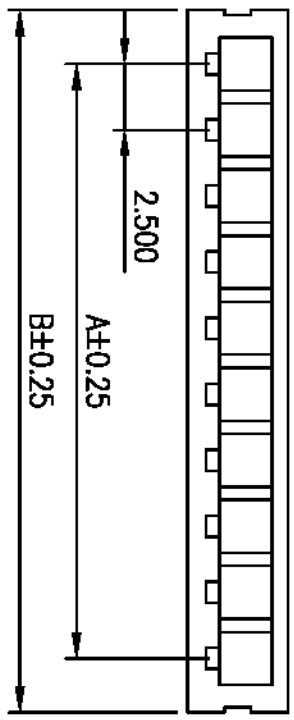

P.C.B LAYOUT

Ordering information:

YY-1000AB-HXX

Pin:02~16
B:Brown

Circuits	Part No	Dimension mm	
		A	B
2	YY-1000AB-H02	2.50	6.60
3	YY-1000AB-H03	5.00	9.10
4	YY-1000AB-H04	7.50	11.60
5	YY-1000AB-H05	10.00	14.10
6	YY-1000AB-H06	12.50	16.60
7	YY-1000AB-H07	15.00	19.10
8	YY-1000AB-H08	17.50	21.60
9	YY-1000AB-H09	20.00	24.10
10	YY-1000AB-H10	22.50	26.60
11	YY-1000AB-H11	25.00	29.10
12	YY-1000AB-H12	27.50	31.60
13	YY-1000AB-H13	30.00	34.10
14	YY-1000AB-H14	32.50	36.60
15	YY-1000AB-H15	35.00	39.10
16	YY-1000AB-H16	37.50	41.60



EDITION	DATE	MODIFY	VIEW	DRAW BY	AUDITING	APPROVAL	DATE	DWG NO	TOLERANCE
A0	2004.03.31	DRAWING		Art Scrth	ALVIN	Jessica	2004.03.31	YY-1000AB-HXX	.00 ±0.15 .000 ±0.05

YOUNG YAK ENTERPRISE CO.,LTD.
 毅耀實業股份有限公司
 TEL:886-2-2999-9629
 FAX:886-2-2999-0575

RoHS compliant

2.5mm (.098") Pitch Housing

YAK E182481

Features:

- * Available in 2 through 16 Circuits
- * Material: Nylon 66 UL94V-0
- * Accepts YY-1000AR-T Crimp Terminal

Specifications:

- * Pitch between Poles 2.5mm
- * Rated Voltage 250V AC,DC
- * Rated Current 3A
- * Withstand Voltage 800V AC/minute
- * Insulation Resistance 1,000M Ohms/min
- * Temperature Range -25°C~+85°C

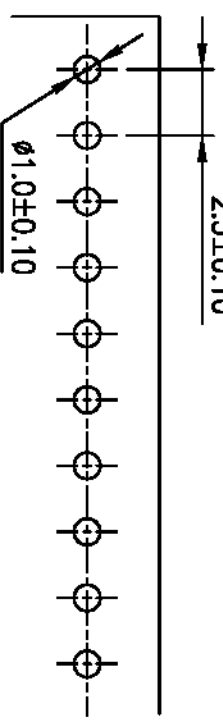
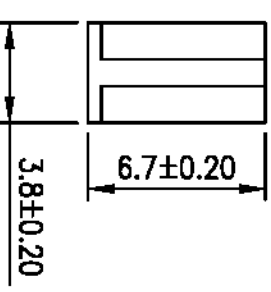
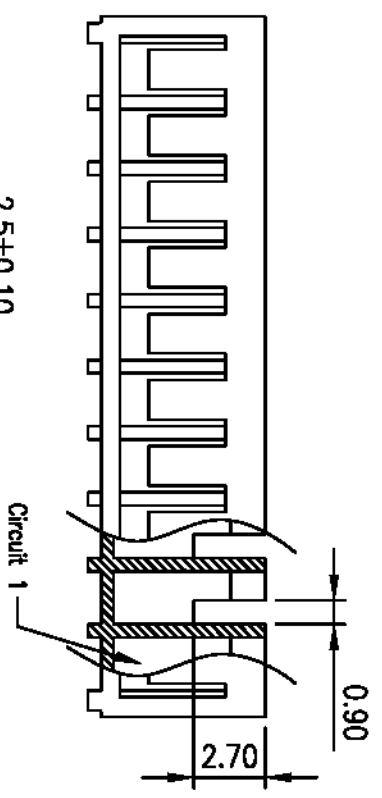
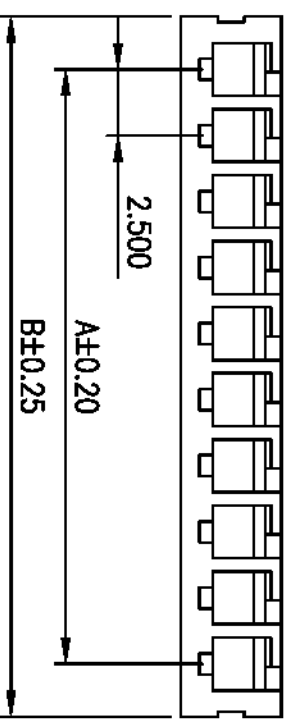

P.C.B LAYOUT

Circuits	Part No	Dimension mm	
		A	B
2	YY-1000AR-H02	2.50	6.50
3	YY-1000AR-H03	5.00	9.00
4	YY-1000AR-H04	7.50	11.50
5	YY-1000AR-H05	10.00	14.00
6	YY-1000AR-H06	12.50	16.50
7	YY-1000AR-H07	15.00	19.00
8	YY-1000AR-H08	17.50	21.50
9	YY-1000AR-H09	20.00	24.00
10	YY-1000AR-H10	22.50	26.50
11	YY-1000AR-H11	25.00	29.00
12	YY-1000AR-H12	27.50	31.50
13	YY-1000AR-H13	30.00	34.00
14	YY-1000AR-H14	32.50	36.50
15	YY-1000AR-H15	35.00	39.00
16	YY-1000AR-H16	37.50	41.50

EDITION	DATE	MODIFY	VIEW	YOUNG YAK ENTERPRISE CO.,LTD.	DRAW BY	AUDITING	APPROVAL	DATE	DWG NO	TOLERANCE
A0	2003.04.05	DRAWING		毅耀實業股份有限公司 YOUNG YAK ENTERPRISE CO.,LTD. TEL:886-2-2999-9629 FAX:886-2-2999-0575	Tranng Sun	ALVIN	Jessica	2003.04.05	YY-1000AR-HXX	.00 ±0.15 .000 ±0.05

2.50mm (.098") Pitch Crimp Terminal

Y E182481

Features:

- * Used in YY-1000A-H Series Housing
- * Accepts AWG 26~30 Wire Range
- * Insulation O.D.= 1.90mm(max)
- * Material : Brass
- * Finish : Tin-Plated
- * Qty/Reel : 10,000 PCS
- * Thickness: 0.2mm

Specification:

- * Pitch Between Poles 2.5mm
- * Rated Voltage 250V AC,DC
- * Rated Current 3A
- * Withstand Voltage 800V AC/minute
- * Insulation Resistance 1,000M Ohms/min
- * Temperature Range -25°C~+85°C

Ordering Information:

YY-1000A-TXXX

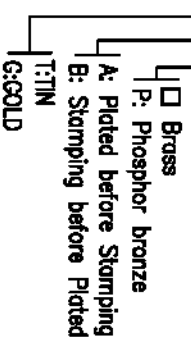
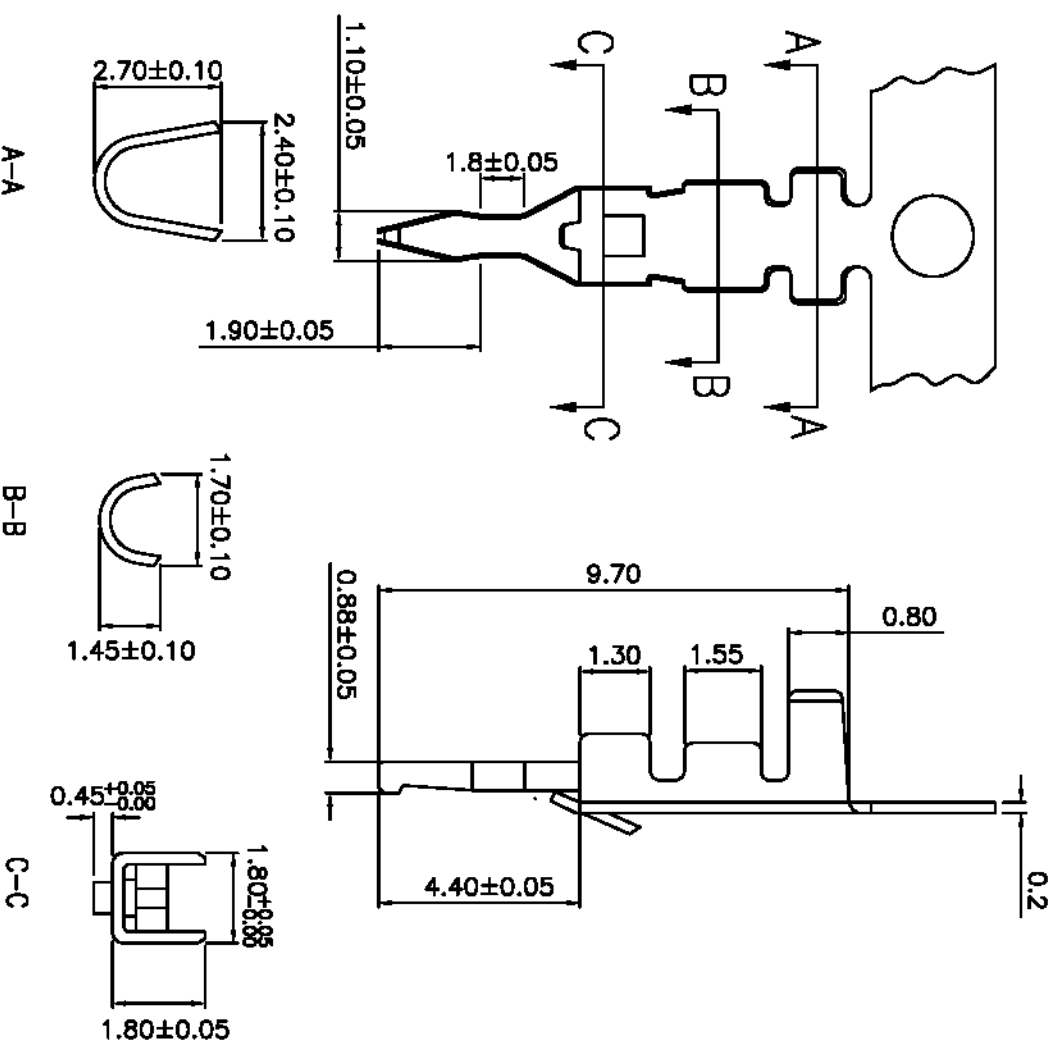

EDITION	DATE	MODIFY	VIEW	YOUNG YAK ENTERPRISE CO.,LTD.	DRAW BY	AUDITING	APPROVAL	DATE	DWG NO	TOLERANCE
A0	2005.04.13	DRAWING		TEL:886-2-2999-9629 FAX:886-2-2999-0575	Z.H.Oyang	JEFF	JESSICA	2005.04.13	B2501T 141-A0	.0 ±0.13 ±0.05

2.5mm (.098") Pitch Crimp Terminal

Y E182481

Features:

- * Used in YY-1000AR-H Series Housing
- * Accepts AWG 22~28 Wire Range
- * Insulation O.D.= 1.90mm(max)
- * Material : Phosphor bronze/Brass
- * Finish : Tin-plated
- * Thickness: 0.2mm
- * Qty/reel: 10,000pcs

Specification:

- * Pitch Between Poles 2.5mm
- * Rated Voltage 250V AC,DC
- * Rated Current 3A
- * Withstand Voltage 800V AC/minute
- * Insulation Resistance 1000M ohms/min
- * Temperature Range -25C~+85C

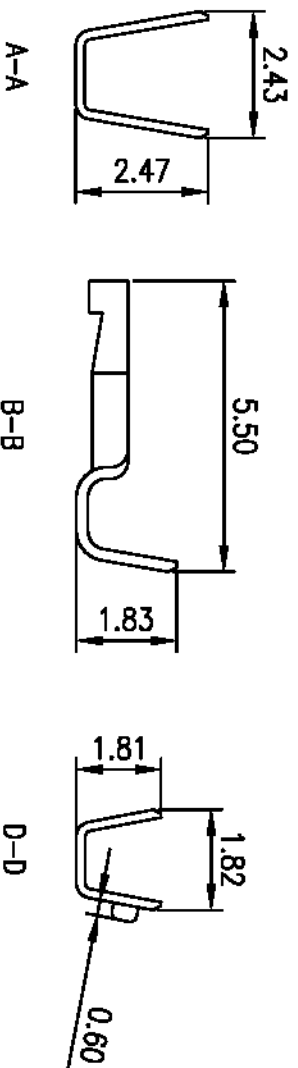
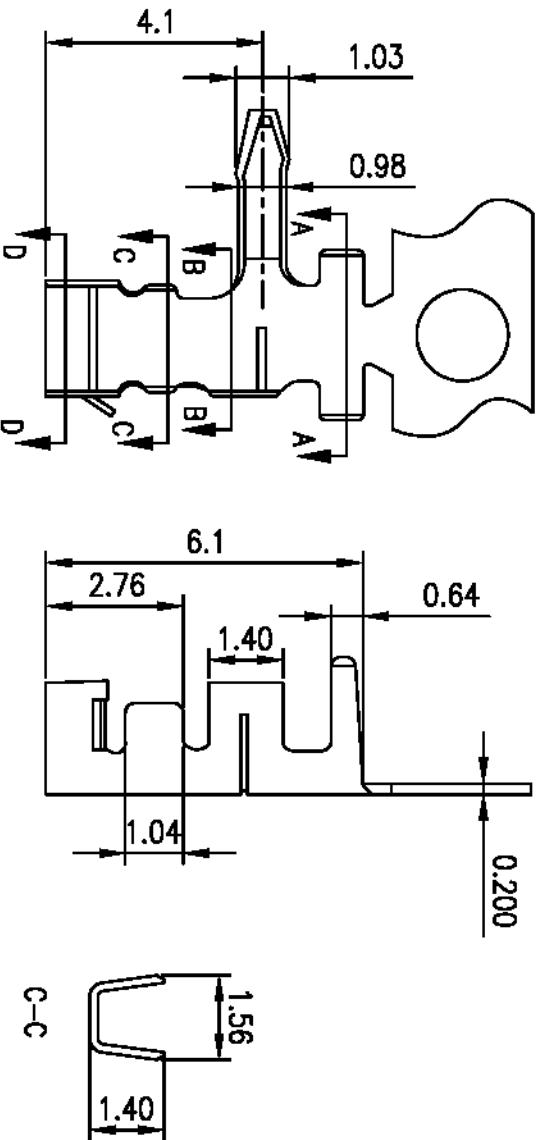

Ordering Information:

YY-1000AR-TXXX

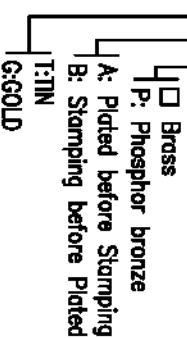

EDITION	DATE	MODIFY	VIEW	DRAW BY	AUDITING	APPROVAL	DATE	DWG NO	TOLERANCE
A0	2002.07.09	DRAWING		ZH.Oyong	Jeff	Jessica	2002.07.09	B2501RT 058-A0	.0 ±0.25
								YY-1000AR-TXXX	±0.15 ±0.08



毅耀實業股份有限公司
YOUNG YAK ENTERPRISE CO.,LTD.

TEL:886-2-2999-9629
FAX:886-2-2999-0575