

**MiniSKiiP® 1 PIM**
**1200V / 15A**
**Features**

- Solderless interconnection
- Trench Fieldstop IGBT3 technology

**MiniSKiiP® 1 housing**

**Target Applications**

- Industrial drives

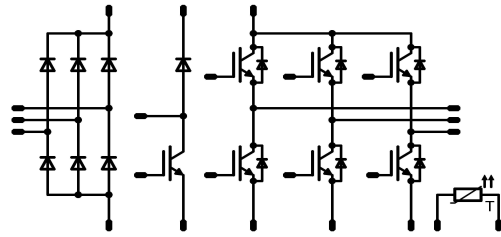
**Schematic**

**Types**

- V23990-K200-A-PM

## Maximum Ratings

 $T_j=25^{\circ}\text{C}$ , unless otherwise specified

| Parameter                       | Symbol     | Condition   | Value | Unit                 |
|---------------------------------|------------|---|-------|----------------------|
| <b>D8,D9,D10,D11,D12,D13</b>    |            |   |       |                      |
| Repetitive peak reverse voltage | $V_{RRM}$  |   | 1600  | V                    |
| DC forward current              | $I_{FAV}$  | $T_j=T_{jmax}$<br>$T_h=80^{\circ}\text{C}$                      | 29    | A                    |
| Surge forward current           | $I_{FSM}$  | $t_p=10\text{ms}$<br>half sine wave<br>$T_j=25^{\circ}\text{C}$ | 220   | A                    |
| $I^2t$ -value                   | $I^2t$     |   | 240   | $\text{A}^2\text{s}$ |
| Power dissipation               | $P_{tot}$  | $T_j=T_{jmax}$<br>$T_h=80^{\circ}\text{C}$                      | 46    | W                    |
| Maximum Junction Temperature    | $T_{jmax}$ |   | 150   | $^{\circ}\text{C}$   |

**T1,T2,T3,T4,T5,T6,T7**

|                                      |                      |   |           |                    |
|--------------------------------------|----------------------|---|-----------|--------------------|
| Collector-emitter break down voltage | $V_{CE}$             |   | 1200      | V                  |
| DC collector current                 | $I_C$                | $T_j=T_{jmax}$<br>$T_h=80^{\circ}\text{C}$              | 20        | A                  |
| Repetitive peak collector current    | $I_{Cpulse}$         | $t_p$ limited by $T_{jmax}$                             | 45        | A                  |
| Power dissipation                    | $P_{tot}$            | $T_j=T_{jmax}$<br>$T_h=80^{\circ}\text{C}$              | 83        | W                  |
| Gate-emitter peak voltage            | $V_{GE}$             |   | $\pm 20$  | V                  |
| Short circuit ratings                | $t_{SC}$<br>$V_{CC}$ | $T_j \leq 150^{\circ}\text{C}$<br>$V_{GE} = 15\text{V}$ | 10<br>900 | $\mu\text{s}$<br>V |
| Maximum Junction Temperature         | $T_{jmax}$           |   | 175       | $^{\circ}\text{C}$ |

## Maximum Ratings

 $T_j=25^{\circ}\text{C}$ , unless otherwise specified

| Parameter                       | Symbol     | Condition                               | Value | Unit               |
|---------------------------------|------------|---|-------|--------------------|
| <b>D1,D2,D3,D4,D5,D6,D7</b>     |            |   |       |                    |
| Repetitive peak reverse voltage | $V_{RRM}$  |   | 1200  | V                  |
| DC forward current              | $I_F$      | $T_j=T_{jmax}$ $T_n=80^{\circ}\text{C}$ | 20    | A                  |
| Repetitive peak forward current | $I_{FRM}$  | $t_p$ limited by $T_{jmax}$             | 42    | A                  |
| Power dissipation               | $P_{tot}$  | $T_j=T_{jmax}$ $T_n=80^{\circ}\text{C}$ | 49    | W                  |
| Maximum Junction Temperature    | $T_{jmax}$ |   | 175   | $^{\circ}\text{C}$ |

### Thermal Properties

|   |           |  |                            |                    |
|---|-----------|--|----------------------------|--------------------|
| Storage temperature                             | $T_{stg}$ |  | -40...+125                 | $^{\circ}\text{C}$ |
| Operation temperature under switching condition | $T_{op}$  |  | -40...+( $T_{jmax} - 25$ ) | $^{\circ}\text{C}$ |

### Insulation Properties

|                    |          |                          |          |    |
|--------------------|----------|--------------------------|----------|----|
| Insulation voltage | $V_{is}$ | $t=2\text{s}$ DC voltage | 4000     | V  |
| Creepage distance  |          |                          | min 12,7 | mm |
| Clearance          |          |                          | min 12,7 | mm |

**Characteristic Values**

| Parameter                                     | Symbol          | Conditions                                  |  |                                  |                  |                                       | Value |                        |        | Unit             |     |
|---|-----------------|---|--|----------------------------------|------------------|---------------------------------------|-------|------------------------|--------|------------------|-----|
|   |                 | $V_{GE}[V]$ or $V_{GS}[V]$                  | $V_r[V]$ or $V_{CE}[V]$ or $V_{DS}[V]$ | $I_c[A]$ or $I_F[A]$ or $I_b[A]$ | $T_j$            | Min                                   | Typ   | Max                    |        |                  |     |
| <b>D8,D9,D10,D11,D12,D13</b>                  |                 |   |  |                                  |                  |                                       |       |                        |        |                  |     |
| Forward voltage                               | $V_F$           |   |  |                                  | 25               | $T_j=25^\circ C$<br>$T_j=125^\circ C$ |       | 1,51<br>1,42           |        | V                |     |
| Threshold voltage (for power loss calc. only) | $V_{to}$        |   |  |                                  |                  | $T_j=25^\circ C$<br>$T_j=125^\circ C$ |       | 0,86<br>0,79           |        | V                |     |
| Slope resistance (for power loss calc. only)  | $r_t$           |   |  |                                  |                  | $T_j=25^\circ C$<br>$T_j=125^\circ C$ |       | 0,0300<br>0,0300       |        | $\Omega$         |     |
| Reverse current                               | $I_r$           |   |  | 1500                             |                  | $T_j=25^\circ C$<br>$T_j=125^\circ C$ |       |                        | 0,05   | mA               |     |
| Thermal resistance chip to heatsink           | $R_{thJH}$      | Thermal grease thickness $\leq 50\mu m$     |  |                                  |                  |                                       |       | 1,5                    |        | K/W              |     |
| <b>T1,T2,T3,T4,T5,T6,T7</b>                   |                 |   |  |                                  |                  |                                       |       |                        |        |                  |     |
| Gate emitter threshold voltage                | $V_{GE(th)}$    | $V_{CE}=V_{GE}$                             |  |                                  | 0,0006           | $T_j=25^\circ C$<br>$T_j=150^\circ C$ | 5     | 5,8                    | 6,5    | V                |     |
| Collector-emitter saturation voltage          | $V_{CE(sat)}$   |   | 15                                     |                                  | 15               | $T_j=25^\circ C$<br>$T_j=150^\circ C$ | 1,4   | 1,86<br>2,11           | 2,1    | V                |     |
| Collector-emitter cut-off current incl. Diode | $I_{CES}$       |   | 0                                      | 1200                             |                  | $T_j=25^\circ C$<br>$T_j=150^\circ C$ |       |                        | 0,0022 | mA               |     |
| Gate-emitter leakage current                  | $I_{GES}$       |   | 20                                     | 0                                |                  | $T_j=25^\circ C$<br>$T_j=150^\circ C$ |       |                        | 120    | nA               |     |
| Integrated Gate resistor                      | $R_{gint}$      |   |  |                                  |                  |                                       |       | -                      |        | $\Omega$         |     |
| Turn-on delay time                            | $t_{d(on)}$     | $R_{goff}=36 \Omega$<br>$R_{gon}=36 \Omega$ | $\pm 15$                               | 600                              | 15               | $T_j=25^\circ C$<br>$T_j=150^\circ C$ |       | 48<br>46               |        | ns               |     |
| Rise time                                     | $t_r$           |   |  |                                  |                  | $T_j=25^\circ C$<br>$T_j=150^\circ C$ |       | 27<br>33               |        |                  |     |
| Turn-off delay time                           | $t_{d(off)}$    |   |  |                                  |                  | $T_j=25^\circ C$<br>$T_j=150^\circ C$ |       | 348<br>424             |        |                  |     |
| Fall time                                     | $t_f$           |   |  |                                  |                  | $T_j=25^\circ C$<br>$T_j=150^\circ C$ |       | 121<br>221             |        |                  |     |
| Turn-on energy loss per pulse                 | $E_{on}$        |   |  |                                  |                  | $T_j=25^\circ C$<br>$T_j=150^\circ C$ |       | 1,54<br>2,04           |        |                  | mWs |
| Turn-off energy loss per pulse                | $E_{off}$       |   |  |                                  |                  | $T_j=25^\circ C$<br>$T_j=150^\circ C$ |       | 1,06<br>1,66           |        |                  |     |
| Input capacitance                             | $C_{ies}$       |   |  |                                  |                  |                                       |       |                        |        |                  |     |
| Output capacitance                            | $C_{oss}$       | f=1MHz                                      | 0                                      | 25                               | $T_j=25^\circ C$ |                                       |       | 100                    |        |                  |     |
| Reverse transfer capacitance                  | $C_{rss}$       |   |  |                                  |                  |                                       |       | 50                     |        |                  |     |
| Gate charge                                   | $Q_{Gate}$      |   | $\pm 15$                               |                                  |                  | $T_j=25^\circ C$                      |       | 108                    |        | nC               |     |
| Thermal resistance chip to heatsink           | $R_{thJH}$      | Thermal grease thickness $\leq 50\mu m$     |  |                                  |                  |                                       |       | 1,15                   |        | K/W              |     |
| <b>D1,D2,D3,D4,D5,D6,D7</b>                   |                 |   |  |                                  |                  |                                       |       |                        |        |                  |     |
| Diode forward voltage                         | $V_F$           |   |  |                                  | 15               | $T_j=25^\circ C$<br>$T_j=150^\circ C$ |       | 1,80<br>1,87           |        | V                |     |
| Peak reverse recovery current                 | $I_{RRM}$       |   |  |                                  |                  | $T_j=25^\circ C$<br>$T_j=150^\circ C$ |       | 12<br>14               |        | A                |     |
| Reverse recovery time                         | $t_{rr}$        |   |  |                                  |                  | $T_j=25^\circ C$<br>$T_j=150^\circ C$ |       | 477<br>651             |        | ns               |     |
| Reverse recovered charge                      | $Q_{rr}$        | $di/dt=t_{bd} A/us$                         | 15                                     | 600                              | 15               | $T_j=25^\circ C$<br>$T_j=150^\circ C$ |       | 2,03<br>3,38           |        | $\mu C$          |     |
| Peak rate of fall of recovery current         | $di(rec)max/dt$ |   |  |                                  |                  | $T_j=25^\circ C$<br>$T_j=150^\circ C$ |       | 91<br>36               |        | A/ $\mu s$       |     |
| Reverse recovered energy                      | Erec            |   |  |                                  |                  | $T_j=25^\circ C$<br>$T_j=150^\circ C$ |       | 0,77<br>1,35           |        | mWs              |     |
| Thermal resistance chip to heatsink           | $R_{thJH}$      | Thermal grease thickness $\leq 50\mu m$     |  |                                  |                  |                                       |       | 1,95                   |        | K/W              |     |
| <b>PTC</b>                                    |                 |   |  |                                  |                  |                                       |       |                        |        |                  |     |
| Rated resistance                              | R               |   |  |                                  |                  | T=25 $^\circ C$                       |       | 1000                   |        | $\Omega$         |     |
| Deviation of R100                             | $\Delta R/R$    | R100=1670 $\Omega$                          |  |                                  |                  | T=100 $^\circ C$                      | -3    |                        | 3      | %                |     |
| R100  | P               |   |  |                                  |                  | T=100 $^\circ C$                      |       | 1670,313               |        | $\Omega$         |     |
| Power dissipation constant                    |                 |   |  |                                  |                  | T=25 $^\circ C$                       |       |                        |        | mW/K             |     |
| A-value                                       | B(25/50)        | Tol. %                                      |  |                                  |                  | T=25 $^\circ C$                       |       | 7,635*10 <sup>-3</sup> |        | 1/K              |     |
| B-value                                       | B(25/100)       | Tol. %                                      |  |                                  |                  | T=25 $^\circ C$                       |       | 1,731*10 <sup>-5</sup> |        | 1/K <sup>2</sup> |     |
| Vincotech NTC Reference                       |                 |   |  |                                  |                  |                                       |       |                        | E      |                  |     |

**T1,T2,T3,T4,T5,T6,T7 / D1,D2,D3,D4,D5,D6,D7**
**Figure 1** IGBT

**Typical output characteristics**

$I_C = f(V_{CE})$

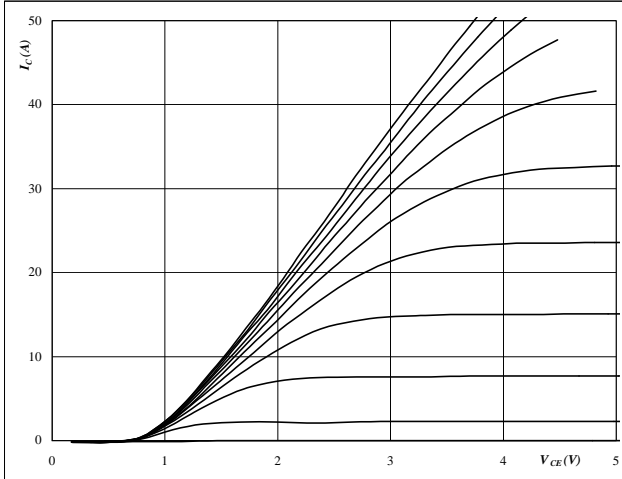

**At**  
 $t_p = 250 \mu s$   
 $T_j = 25 \text{ }^\circ C$   
 $V_{GE}$  from 7 V to 17 V in steps of 1 V

**Figure 2** IGBT

**Typical output characteristics**

$I_C = f(V_{CE})$

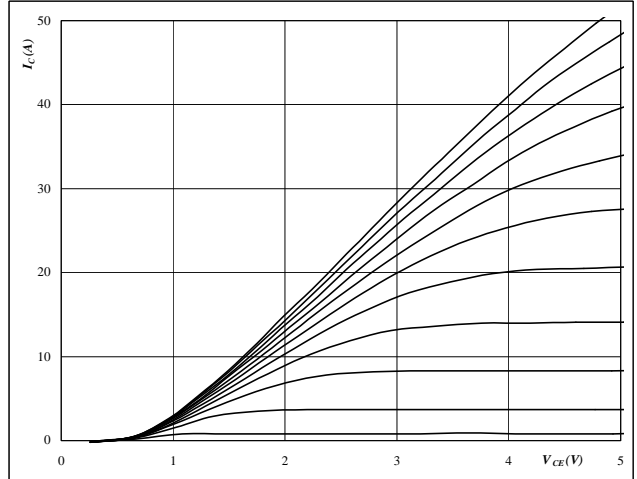

**At**  
 $t_p = 250 \mu s$   
 $T_j = 125 \text{ }^\circ C$   
 $V_{GE}$  from 7 V to 17 V in steps of 1 V

**Figure 3** IGBT

**Typical transfer characteristics**

$I_C = f(V_{GE})$

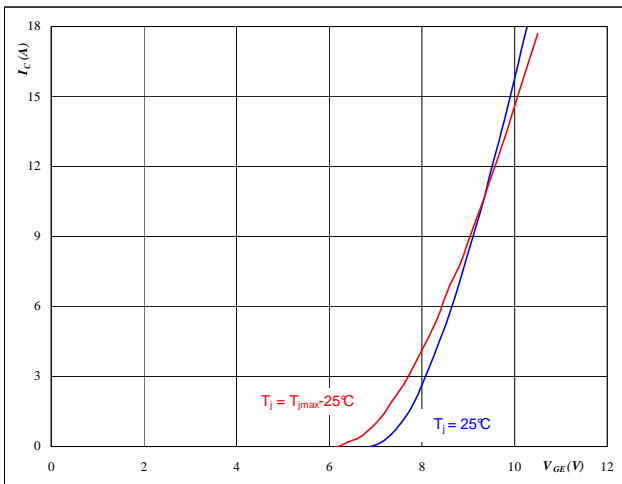

**At**  
 $t_p = 250 \mu s$   
 $V_{CE} = 10 V$

**Figure 4** FWD

**Typical diode forward current as a function of forward voltage**

$I_F = f(V_F)$

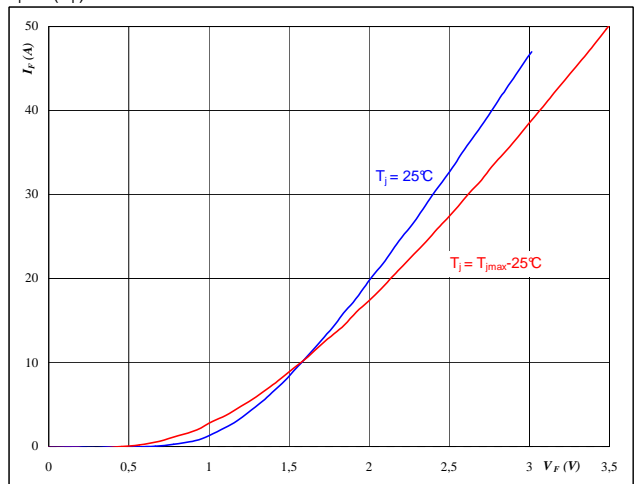

**At**  
 $t_p = 250 \mu s$

**T1,T2,T3,T4,T5,T6,T7 / D1,D2,D3,D4,D5,D6,D7**
**Figure 5** IGBT

**Typical switching energy losses as a function of collector current**

$$E = f(I_C)$$

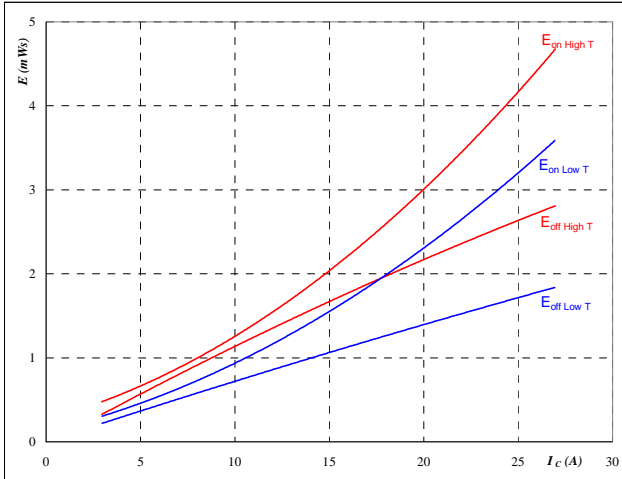

With an inductive load at

 $T_j = 25/125 \text{ } ^\circ\text{C}$   
 $V_{CE} = 600 \text{ V}$   
 $V_{GE} = \pm 15 \text{ V}$   
 $R_{gon} = 54 \text{ } \Omega$   
 $R_{goff} = 54 \text{ } \Omega$ 
**Figure 6** IGBT

**Typical switching energy losses as a function of gate resistor**

$$E = f(R_G)$$

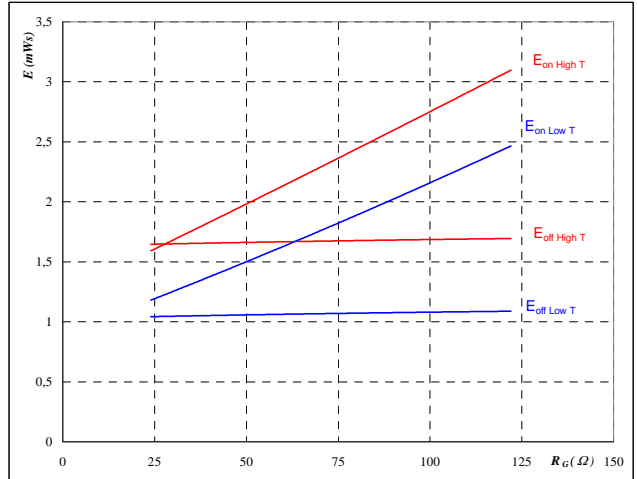

With an inductive load at

 $T_j = 25/125 \text{ } ^\circ\text{C}$   
 $V_{CE} = 600 \text{ V}$   
 $V_{GE} = \pm 15 \text{ V}$   
 $I_C = 15 \text{ A}$ 
**Figure 7** IGBT

**Typical reverse recovery energy loss as a function of collector current**

$$E_{rec} = f(I_C)$$

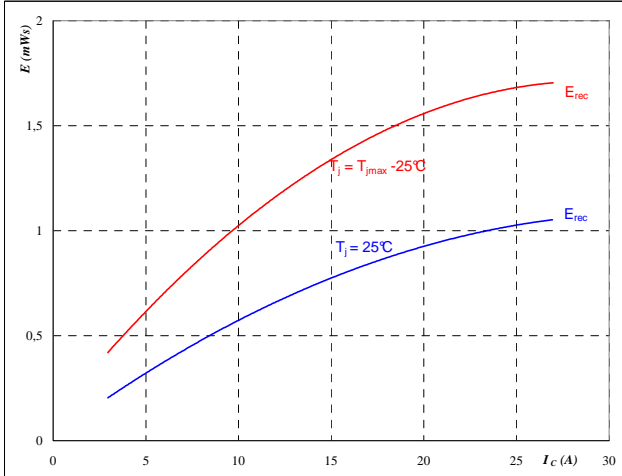

With an inductive load at

 $T_j = 25/125 \text{ } ^\circ\text{C}$   
 $V_{CE} = 600 \text{ V}$   
 $V_{GE} = \pm 15 \text{ V}$   
 $R_{gon} = 54 \text{ } \Omega$ 
**Figure 8** IGBT

**Typical reverse recovery energy loss as a function of gate resistor**

$$E_{rec} = f(R_G)$$

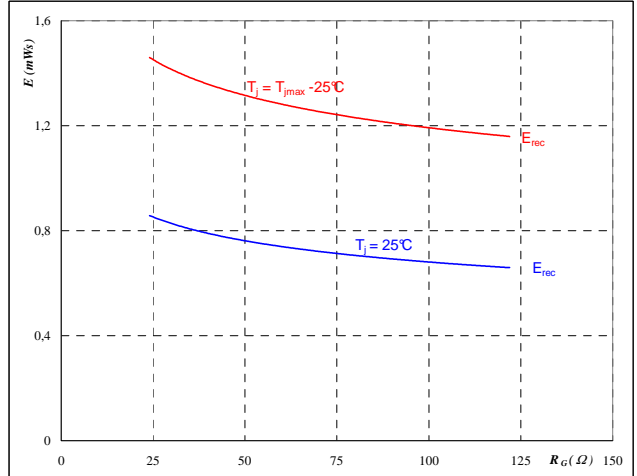

With an inductive load at

 $T_j = 25/125 \text{ } ^\circ\text{C}$   
 $V_{CE} = 600 \text{ V}$   
 $V_{GE} = \pm 15 \text{ V}$   
 $I_C = 15 \text{ A}$

**T1,T2,T3,T4,T5,T6,T7 / D1,D2,D3,D4,D5,D6,D7**
**Figure 9** IGBT

**Typical switching times as a function of collector current**

$t = f(I_C)$

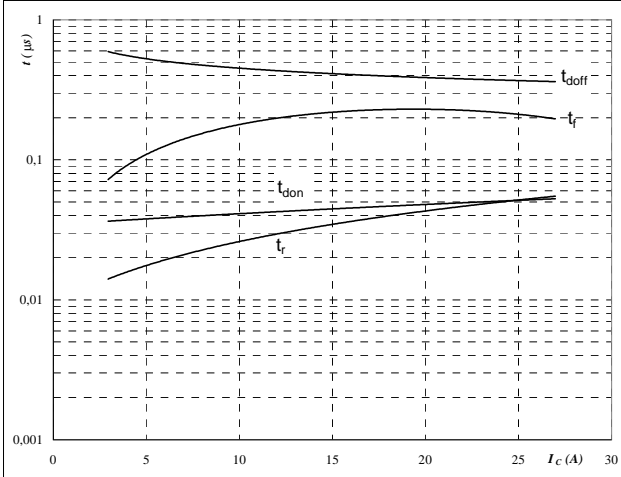

With an inductive load at

|              |     |    |
|--------------|-----|----|
| $T_j =$      | 125 | °C |
| $V_{CE} =$   | 600 | V  |
| $V_{GE} =$   | ±15 | V  |
| $R_{gon} =$  | 54  | Ω  |
| $R_{goff} =$ | 54  | Ω  |

**Figure 10** IGBT

**Typical switching times as a function of gate resistor**

$t = f(R_G)$

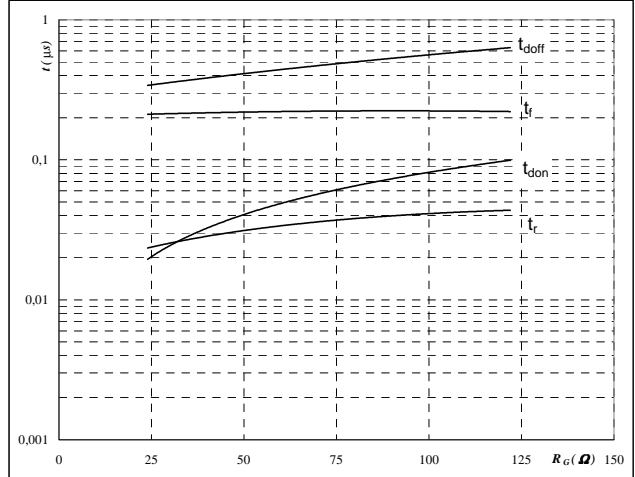

With an inductive load at

|            |     |    |
|------------|-----|----|
| $T_j =$    | 125 | °C |
| $V_{CE} =$ | 600 | V  |
| $V_{GE} =$ | ±15 | V  |
| $I_C =$    | 15  | A  |

**Figure 11** FWD

**Typical reverse recovery time as a function of collector current**

$t_{rr} = f(I_C)$

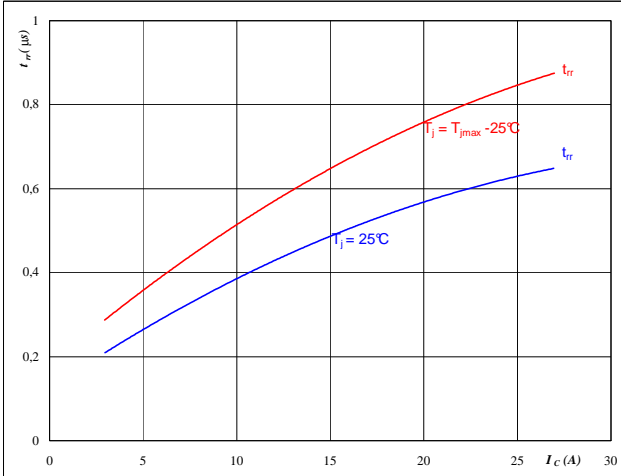

**At**

|             |        |    |
|-------------|--------|----|
| $T_j =$     | 25/125 | °C |
| $V_{CE} =$  | 600    | V  |
| $V_{GE} =$  | ±15    | V  |
| $R_{gon} =$ | 54     | Ω  |

**Figure 12** FWD

**Typical reverse recovery time as a function of IGBT turn on gate resistor**

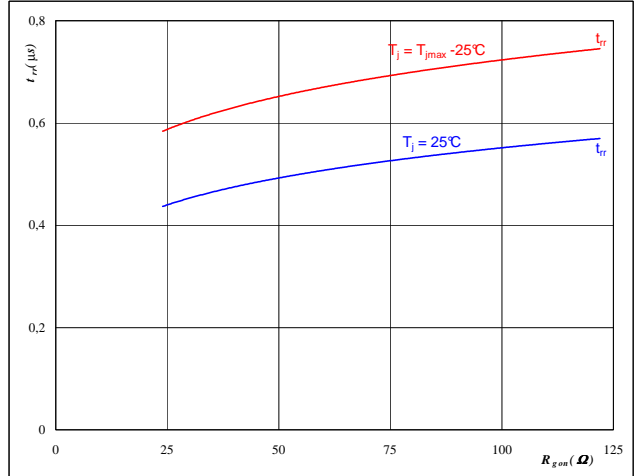
$t_{rr} = f(R_{gon})$



**At**

|            |        |    |
|------------|--------|----|
| $T_j =$    | 25/125 | °C |
| $V_R =$    | 600    | V  |
| $I_F =$    | 15     | A  |
| $V_{GE} =$ | ±15    | V  |

**T1,T2,T3,T4,T5,T6,T7 / D1,D2,D3,D4,D5,D6,D7**
**Figure 13** FWD

**Typical reverse recovery charge as a function of collector current**

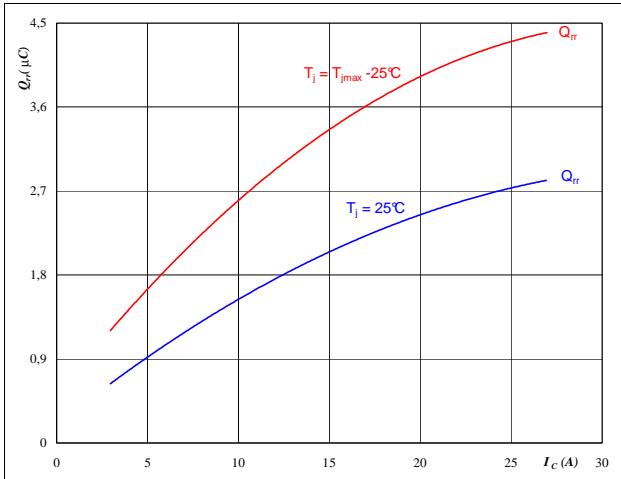
$$Q_{rr} = f(I_C)$$

**At**
 $T_j = 25/125 \text{ } ^\circ\text{C}$   
 $V_{CE} = 600 \text{ V}$   
 $V_{GE} = \pm 15 \text{ V}$   
 $R_{gon} = 54 \text{ } \Omega$ 
**Figure 14** FWD

**Typical reverse recovery charge as a function of IGBT turn on gate resistor**

$$Q_{rr} = f(R_{gon})$$

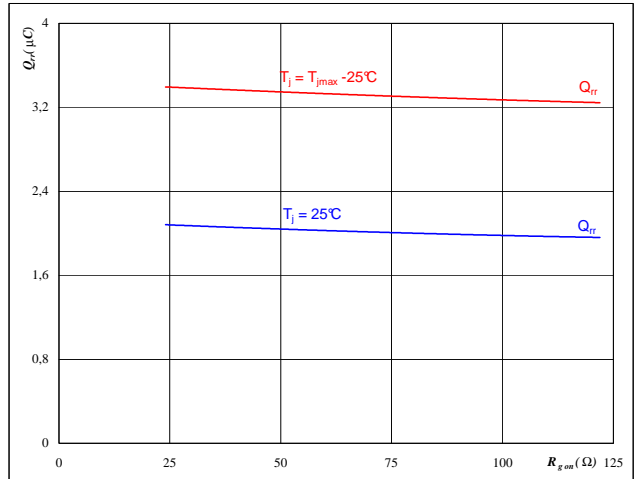
**At**
 $T_j = 25/125 \text{ } ^\circ\text{C}$   
 $V_R = 600 \text{ V}$   
 $I_F = 15 \text{ A}$   
 $V_{GE} = \pm 15 \text{ V}$ 
**Figure 15** FWD

**Typical reverse recovery current as a function of collector current**

$$I_{RRM} = f(I_C)$$

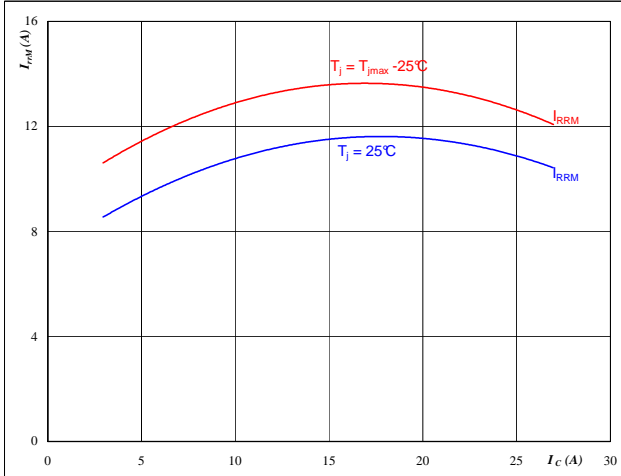
**At**
 $T_j = 25/125 \text{ } ^\circ\text{C}$   
 $V_{CE} = 600 \text{ V}$   
 $V_{GE} = \pm 15 \text{ V}$   
 $R_{gon} = 54 \text{ } \Omega$ 
**Figure 16** FWD

**Typical reverse recovery current as a function of IGBT turn on gate resistor**

$$I_{RRM} = f(R_{gon})$$

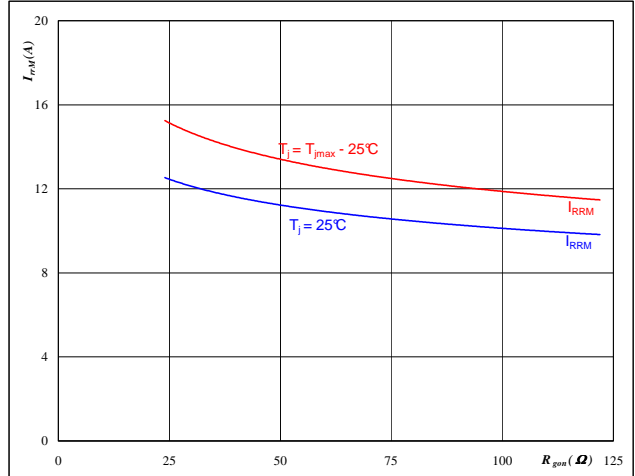
**At**
 $T_j = 25/125 \text{ } ^\circ\text{C}$   
 $V_R = 600 \text{ V}$   
 $I_F = 15 \text{ A}$   
 $V_{GE} = \pm 15 \text{ V}$

**T1,T2,T3,T4,T5,T6,T7 / D1,D2,D3,D4,D5,D6,D7**
**Figure 17** FWD

**Typical rate of fall of forward and reverse recovery current as a function of collector current**

$$di_o/dt, di_{rec}/dt = f(I_c)$$

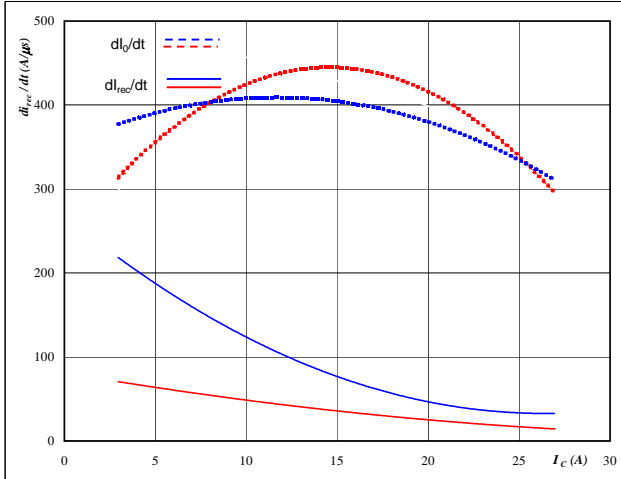
**At**
 $T_j = 25/125 \text{ } ^\circ\text{C}$   
 $V_{CE} = 600 \text{ V}$   
 $V_{GE} = \pm 15 \text{ V}$   
 $R_{gon} = 54 \text{ } \Omega$ 
**Figure 18** FWD

**Typical rate of fall of forward and reverse recovery current as a function of IGBT turn on gate resistor**

$$di_o/dt, di_{rec}/dt = f(R_{gon})$$

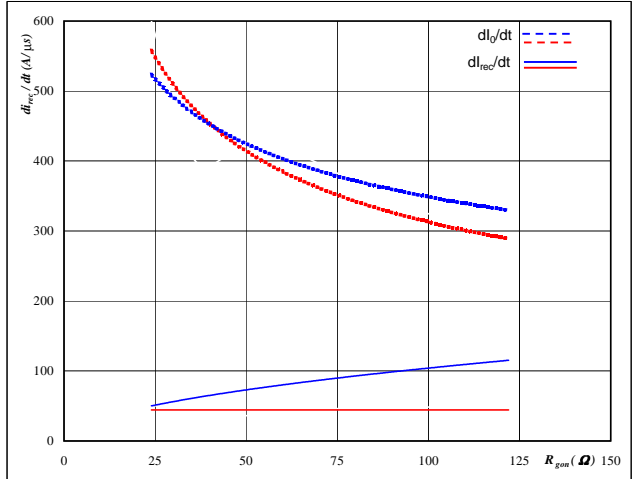
**At**
 $T_j = 25/125 \text{ } ^\circ\text{C}$   
 $V_R = 600 \text{ V}$   
 $I_F = 15 \text{ A}$   
 $V_{GE} = \pm 15 \text{ V}$ 
**Figure 19** IGBT

**IGBT transient thermal impedance as a function of pulse width**

$$Z_{thJH} = f(t_p)$$

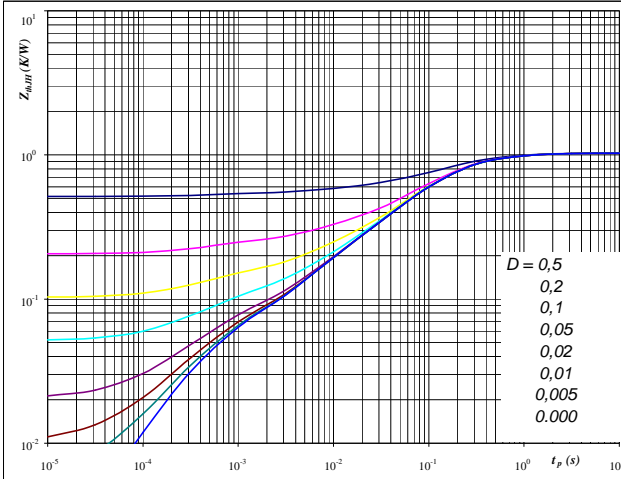
**At**
 $D = t_p / T$   
 $R_{thJH} = 1,15 \text{ K/W}$ 

IGBT thermal model values

| R (K/W) | Tau (s) |
|---------|---------|
| 0,08    | 1,3E+00 |
| 0,48    | 2,0E-01 |
| 0,32    | 5,9E-02 |
| 0,09    | 7,3E-03 |
| 0,05    | 4,5E-04 |

**Figure 20** FWD

**FWD transient thermal impedance as a function of pulse width**

$$Z_{thJH} = f(t_p)$$

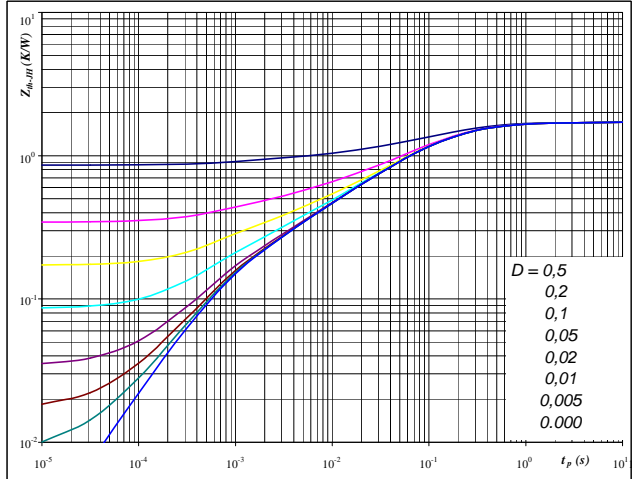
**At**
 $D = t_p / T$   
 $R_{thJH} = 1,95 \text{ K/W}$ 

FWD thermal model values

| R (K/W) | Tau (s) |
|---------|---------|
| 0,09    | 2,0E+00 |
| 0,60    | 2,1E-01 |
| 0,61    | 5,6E-02 |
| 0,26    | 8,0E-03 |
| 0,15    | 8,1E-04 |

**T1,T2,T3,T4,T5,T6,T7 / D1,D2,D3,D4,D5,D6,D7**
**Figure 21** IGBT

**Power dissipation as a function of heatsink temperature**

$$P_{tot} = f(T_h)$$

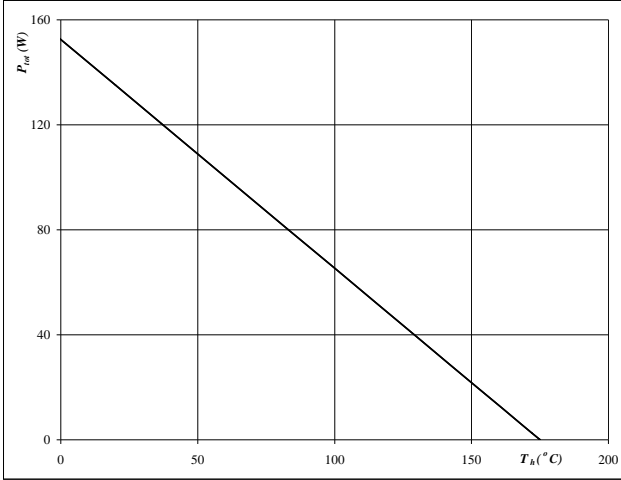
**At**  
 $T_j = 175 \text{ } ^\circ\text{C}$ 
**Figure 22** IGBT

**Collector current as a function of heatsink temperature**

$$I_C = f(T_h)$$

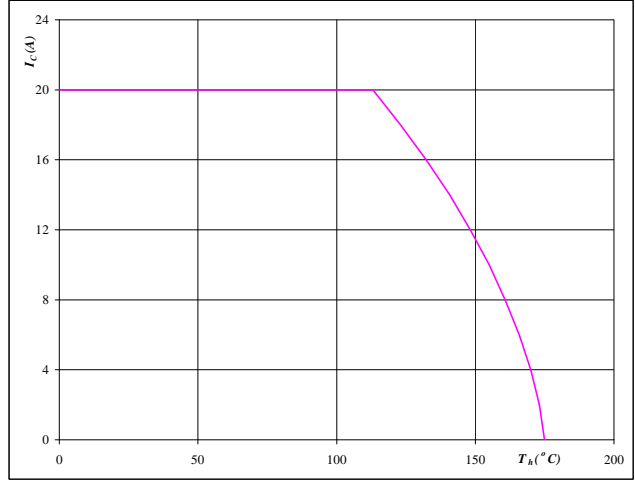
**At**  
 $T_j = 175 \text{ } ^\circ\text{C}$   
 $V_{GE} = 15 \text{ V}$ 
**Figure 23** FWD

**Power dissipation as a function of heatsink temperature**

$$P_{tot} = f(T_h)$$

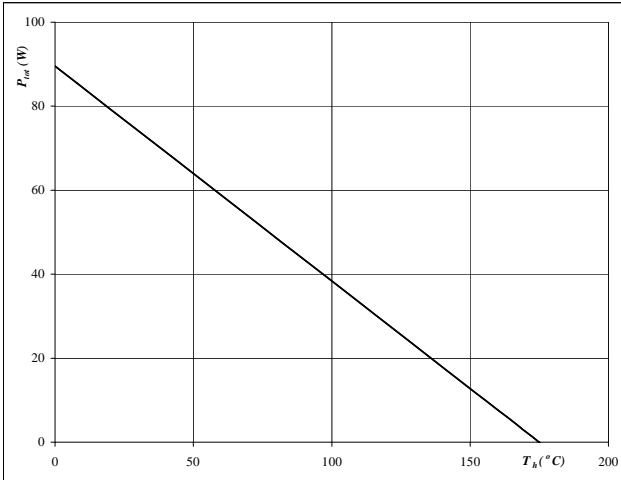
**At**  
 $T_j = 175 \text{ } ^\circ\text{C}$ 
**Figure 24** FWD

**Forward current as a function of heatsink temperature**

$$I_F = f(T_h)$$

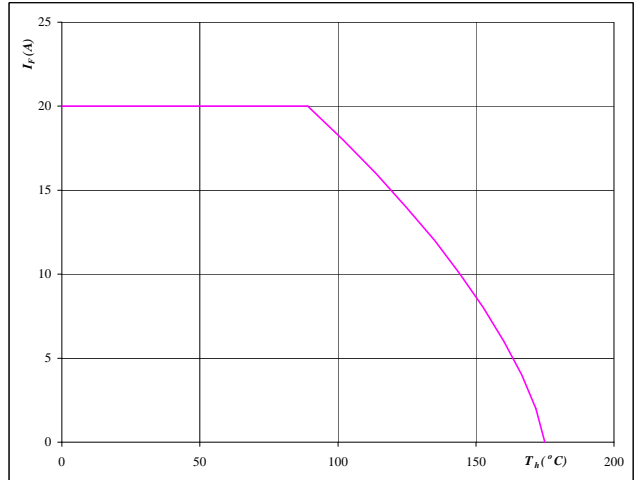
**At**  
 $T_j = 175 \text{ } ^\circ\text{C}$

**T1,T2,T3,T4,T5,T6,T7 / D1,D2,D3,D4,D5,D6,D7**
**Figure 25** IGBT

**Safe operating area as a function of collector-emitter voltage**

$I_C = f(V_{CE})$

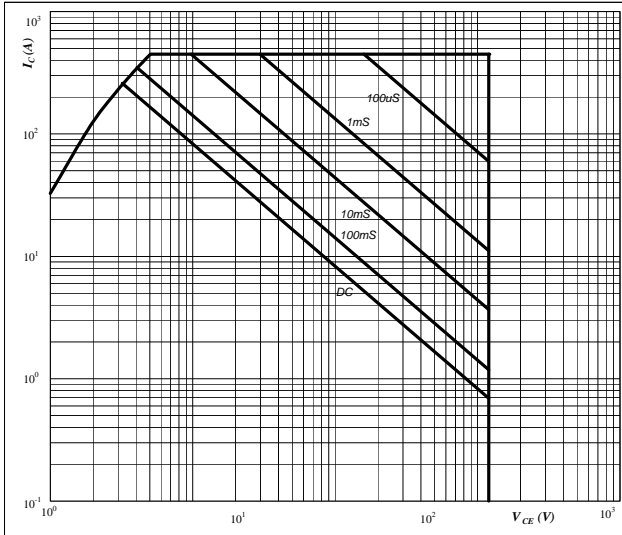

**At**  
 D = single pulse  
 $T_n = 80$  °C  
 $V_{GE} = \pm 15$  V  
 $T_j = T_{jmax}$  °C

**Figure 26** IGBT

**Gate voltage vs Gate charge**

$V_{GE} = f(Q_{GE})$

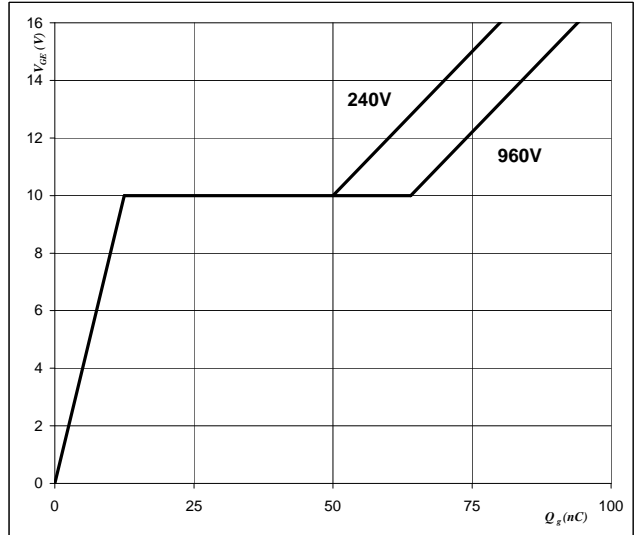

**At**  
 $I_C = 15$  A

**D8,D9,D10,D11,D12,D13**
**Figure 1** Diode

**Typical diode forward current as a function of forward voltage**

$$I_F = f(V_F)$$

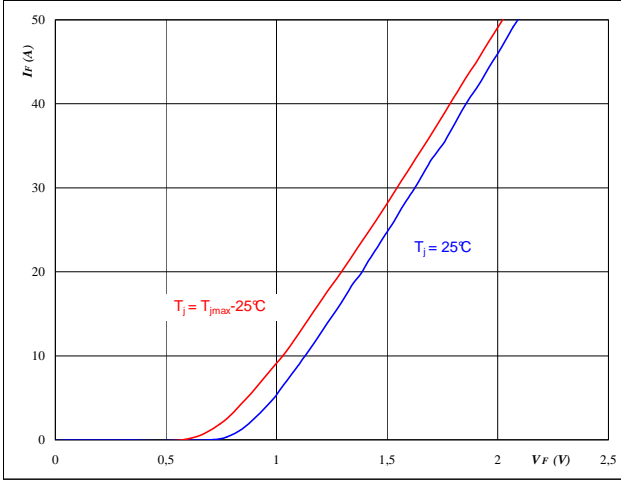
**At**  
 $t_p = 250 \mu s$ 
**Figure 2** Diode

**Diode transient thermal impedance as a function of pulse width**

$$Z_{thJH} = f(t_p)$$

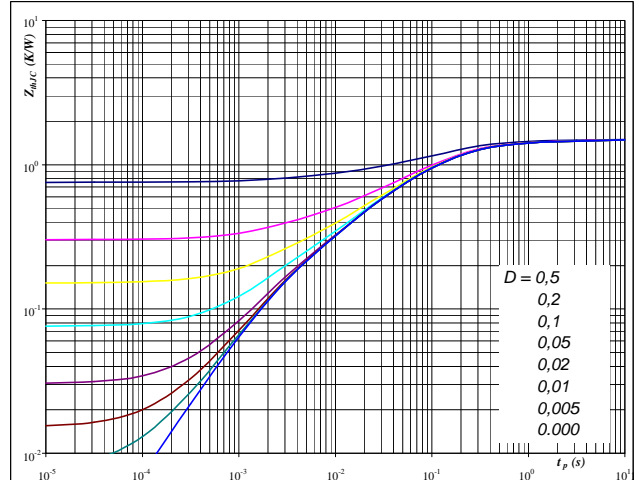
**At**  
 $D = t_p / T$   
 $R_{thJH} = 1,5 \text{ K/W}$ 
**Figure 3** Diode

**Power dissipation as a function of heatsink temperature**

$$P_{tot} = f(T_h)$$

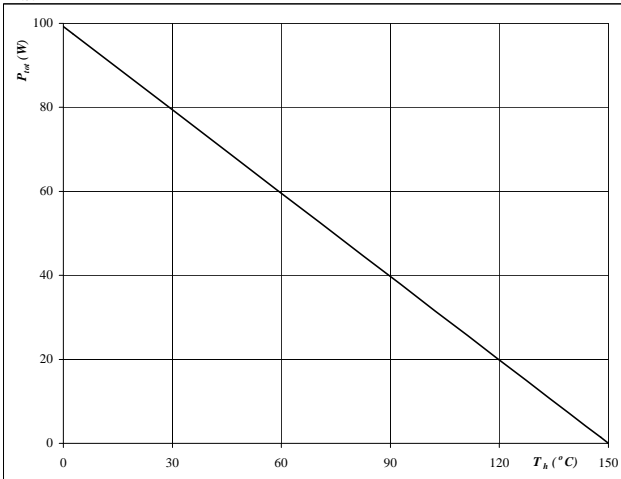
**At**  
 $T_j = 150 \text{ °C}$ 
**Figure 4** Diode

**Forward current as a function of heatsink temperature**

$$I_F = f(T_h)$$

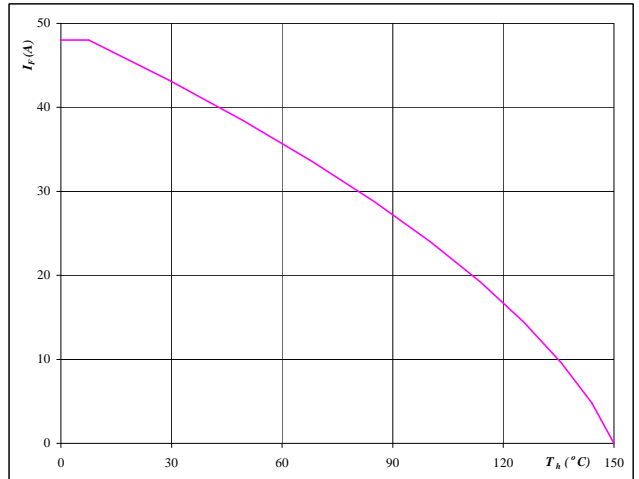

**At**  
 $T_j = 150 \text{ °C}$

## Thermistor

Figure 1 Thermistor

Typical PTC characteristic  
as a function of temperature

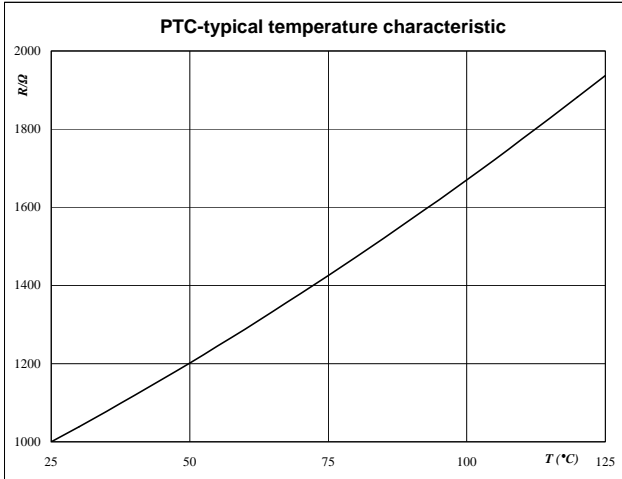
$$R_T = f(T)$$



## Switching Definitions Output Inverter

| General conditions |               |
|--------------------|---------------|
| $T_j$              | = 150 °C      |
| $R_{gon}$          | = 32 $\Omega$ |
| $R_{goff}$         | = 32 $\Omega$ |

**Figure 1** Output inverter IGBT

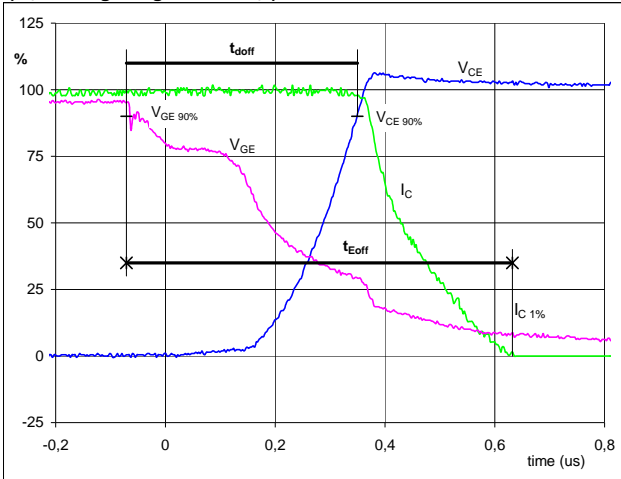
**Turn-off Switching Waveforms & definition of  $t_{doff}$ ,  $t_{Eoff}$**   
 ( $t_{Eoff}$  = integrating time for  $E_{off}$ )

|                   |      |         |
|-------------------|------|---------|
| $V_{GE}(0\%) =$   | -15  | V       |
| $V_{GE}(100\%) =$ | 15   | V       |
| $V_C(100\%) =$    | 600  | V       |
| $I_C(100\%) =$    | 15   | A       |
| $t_{doff} =$      | 0,42 | $\mu$ s |
| $t_{Eoff} =$      | 0,70 | $\mu$ s |

**Figure 2** Output inverter IGBT

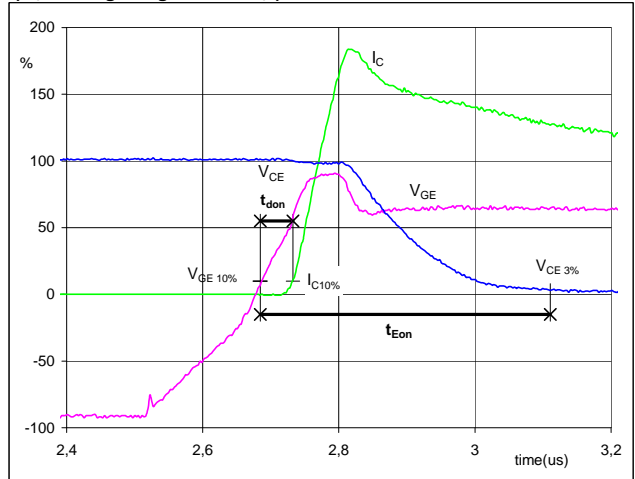
**Turn-on Switching Waveforms & definition of  $t_{don}$ ,  $t_{Eon}$**   
 ( $t_{Eon}$  = integrating time for  $E_{on}$ )

|                    |      |         |
|--------------------|------|---------|
| $V_{GE}(-100\%) =$ | -15  | V       |
| $V_{GE}(100\%) =$  | 15   | V       |
| $V_C(100\%) =$     | 600  | V       |
| $I_C(100\%) =$     | 15   | A       |
| $t_{don} =$        | 0,05 | $\mu$ s |
| $t_{Eon} =$        | 0,43 | $\mu$ s |

**Figure 3** Output inverter IGBT

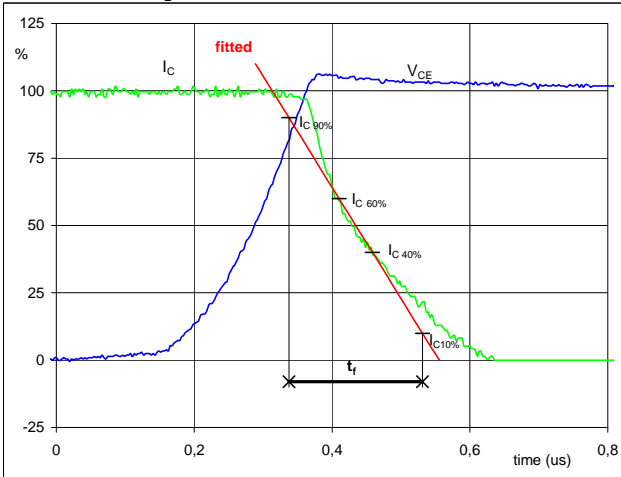
**Turn-off Switching Waveforms & definition of  $t_f$** 

|                |      |         |
|----------------|------|---------|
| $V_C(100\%) =$ | 600  | V       |
| $I_C(100\%) =$ | 15   | A       |
| $t_f =$        | 0,22 | $\mu$ s |

**Figure 4** Output inverter IGBT

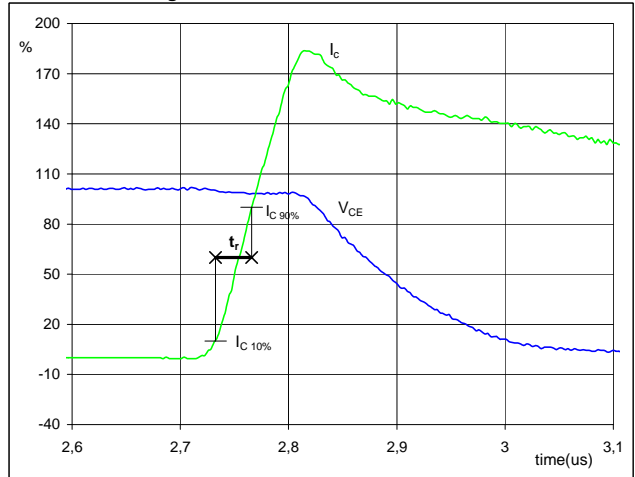
**Turn-on Switching Waveforms & definition of  $t_r$** 

|                |      |         |
|----------------|------|---------|
| $V_C(100\%) =$ | 600  | V       |
| $I_C(100\%) =$ | 15   | A       |
| $t_r =$        | 0,03 | $\mu$ s |

## Switching Definitions Output Inverter

**Figure 5** Output inverter IGBT

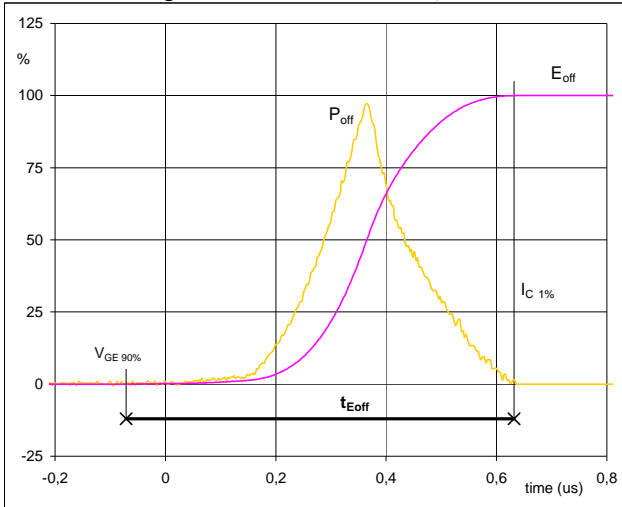
**Turn-off Switching Waveforms & definition of  $t_{Eoff}$** 

|                    |      |         |
|--------------------|------|---------|
| $P_{off}$ (100%) = | 8,95 | kW      |
| $E_{off}$ (100%) = | 1,66 | mJ      |
| $t_{Eoff}$ =       | 0,70 | $\mu$ s |

**Figure 6** Output inverter IGBT

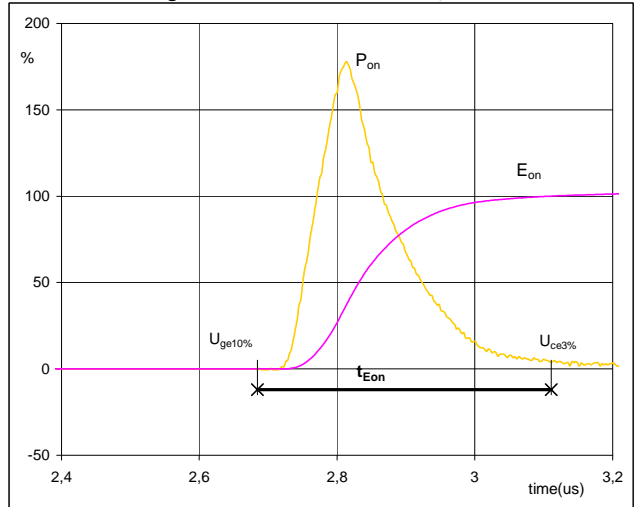
**Turn-on Switching Waveforms & definition of  $t_{Eon}$** 

|                   |      |         |
|-------------------|------|---------|
| $P_{on}$ (100%) = | 8,95 | kW      |
| $E_{on}$ (100%) = | 2,04 | mJ      |
| $t_{Eon}$ =       | 0,43 | $\mu$ s |

**Figure 7** Output inverter IGBT

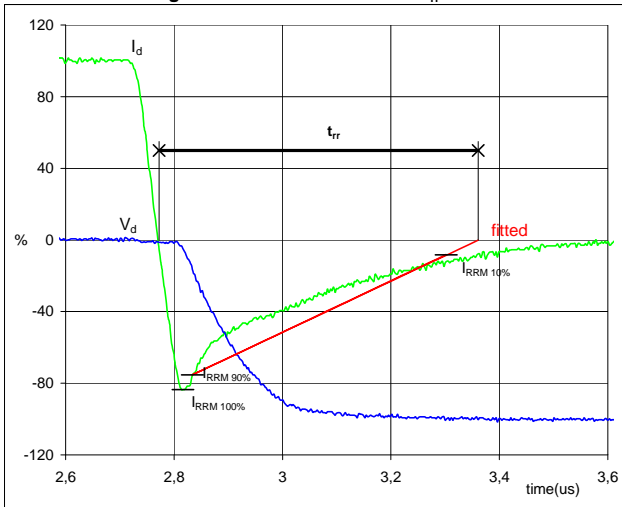
**Turn-off Switching Waveforms & definition of  $t_{rr}$** 

|                    |      |         |
|--------------------|------|---------|
| $V_d$ (100%) =     | 600  | V       |
| $I_d$ (100%) =     | 15   | A       |
| $I_{RRM}$ (100%) = | 14   | A       |
| $t_{rr}$ =         | 0,65 | $\mu$ s |

## Switching Definitions Output Inverter

**Figure 8** Output inverter FWD

Turn-on Switching Waveforms & definition of  $t_{Qrr}$   
 ( $t_{Qrr}$  = integrating time for  $Q_{rr}$ )

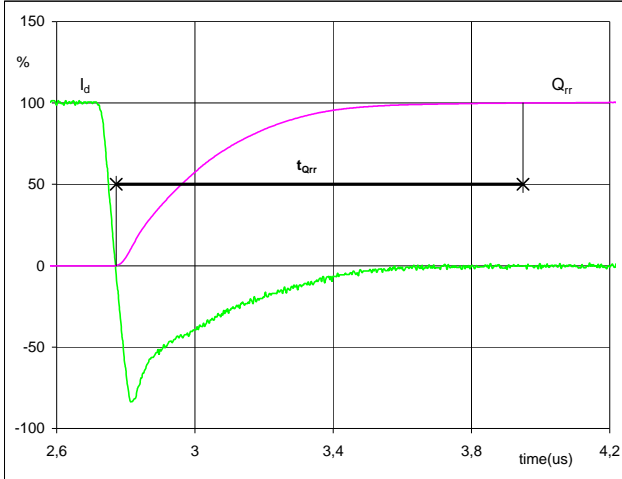

|                   |      |               |
|-------------------|------|---------------|
| $I_d$ (100%) =    | 15   | A             |
| $Q_{rr}$ (100%) = | 3,38 | $\mu\text{C}$ |
| $t_{Qrr}$ =       | 1,18 | $\mu\text{s}$ |

**Figure 9** Output inverter FWD

Turn-on Switching Waveforms & definition of  $t_{Erec}$   
 ( $t_{Erec}$  = integrating time for  $E_{rec}$ )

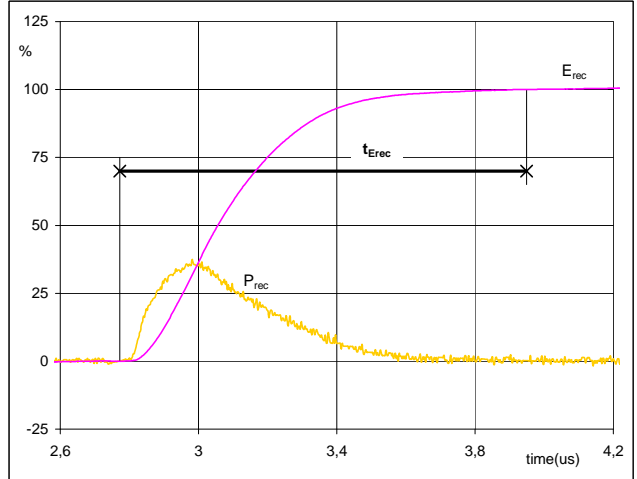

|                    |      |               |
|--------------------|------|---------------|
| $P_{rec}$ (100%) = | 8,95 | kW            |
| $E_{rec}$ (100%) = | 1,35 | mJ            |
| $t_{Erec}$ =       | 1,18 | $\mu\text{s}$ |

**Ordering Code and Marking - Outline - Pinout**
**Ordering Code & Marking**

| Version                                       | Ordering Code         | in DataMatrix as | in packaging barcode as |
|---|-----------------------|------------------|-------------------------|
| with std lid (black V23990-K12-T-PM)          | V23990-K200-A-/0A/-PM | K200A            | K200A-/0A/              |
| with std lid (black V23990-K12-T-PM) and P12  | V23990-K200-A-/1A/-PM | K200A            | K200A-/1A/              |
| with thin lid (white V23990-K13-T-PM)         | V23990-K200-A-/0B/-PM | K200A            | K200A-/0B/              |
| with thin lid (white V23990-K13-T-PM) and P12 | V23990-K200-A-/1B/-PM | K200A            | K200A-/1B/              |

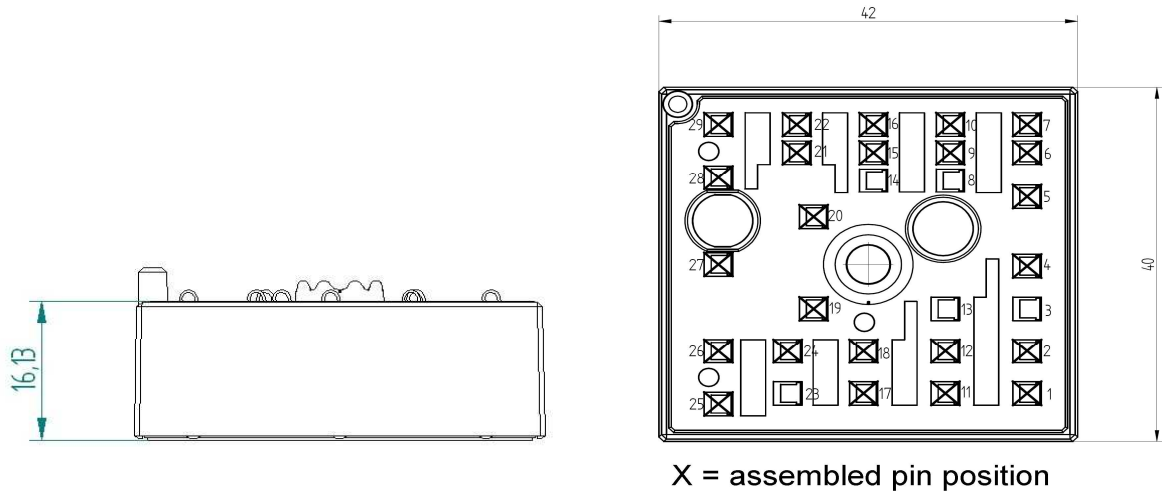
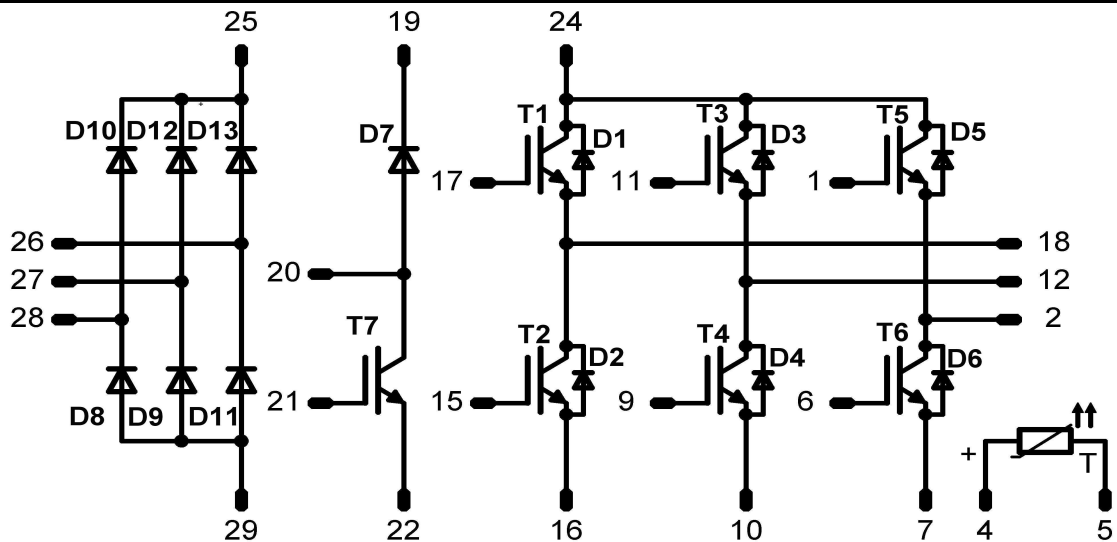
**Outline**

**Pinout**

**DISCLAIMER**

The information given in this datasheet describes the type of component and does not represent assured characteristics. For tested values please contact Vincotech. Vincotech reserves the right to make changes without further notice to any products herein to improve reliability, function or design. Vincotech does not assume any liability arising out of the application or use of any product or circuit described herein; neither does it convey any license under its patent rights, nor the rights of others.

**LIFE SUPPORT POLICY**

Vincotech products are not authorised for use as critical components in life support devices or systems without the express written approval of Vincotech.

As used herein:

1. Life support devices or systems are devices or systems which, (a) are intended for surgical implant into the body, or (b) support or sustain life, or (c) whose failure to perform when properly used in accordance with instructions for use provided in labelling can be reasonably expected to result in significant injury to the user.
2. A critical component is any component of a life support device or system whose failure to perform can be reasonably expected to cause the failure of the life support device or system, or to affect its safety or effectiveness.