

COMMERCIAL & MILITARY GRADES



Features:

- Single & double pole, double throw switch configuration
- Low level rating available with gold plate contacts & terminals
- 3-position center OFF with momentary or maintained switch action in any combination
- Dusttight to MIL-PRF-8805 Design 2
- Raised & flush button contours available
- Choice of button color
- FAA/PMA available (contact factory)
- RoHS/WEEE/Reach compliant

Standard Characteristics/Ratings:

ELECTRICAL RATINGS:

Load	Sea Level @ 28VDC or 115VAC, 60/400Hz
Resistive	5A
Inductive	3A
Lamp	1A
DWV	1050Vrms
Low Level	10mA @ 30mV
Electrical Life:	100,000 cycles
Mechanical Life:	100,000 cycles
Seal:	Dusttight per MIL-PRF-8805 Design 2
Operating Temp Range:	-55°C to +85°C
Operating Force:	24 oz +/- 10 oz
Return Force:	10 oz +8 oz/-3 oz to center from maintained position
Total Travel:	0.120 inches max two directions
Overtravel:	0.010 inches min

MATERIALS:

Case:	Thermoplastic
Button:	Thermoplastic
Terminals:	Copper with silver, Gold over silver for low level
Terminal Hardware:	None provided
Mounting Hardware:	Hex nut and lockwasher

SL PART NUMBER CODE

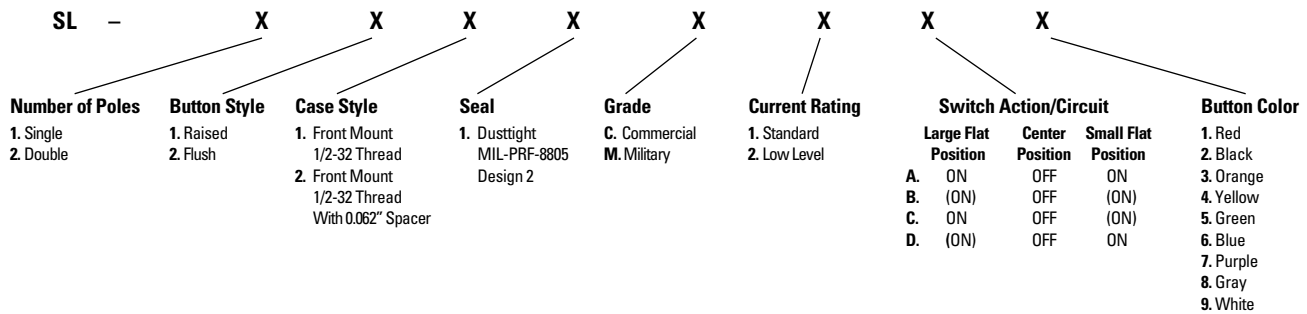

NOTE: () denotes momentary action.

SL Slide Switch

3-Position, Center OFF
SL-1111 Series

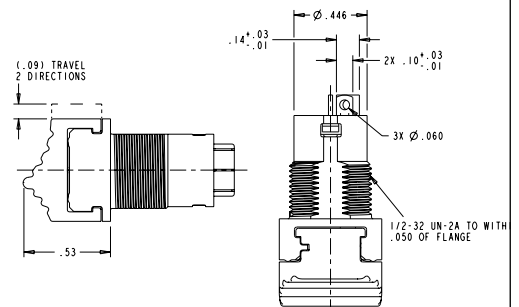
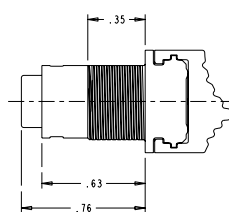
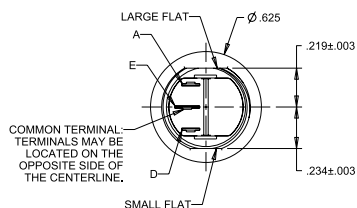
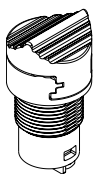

SLIDE SWITCH

SL
SLIDE
SWITCH

COMMERCIAL & MILITARY GRADES

SL Slide Switch

3-Position, Center OFF
SL-1211 Series

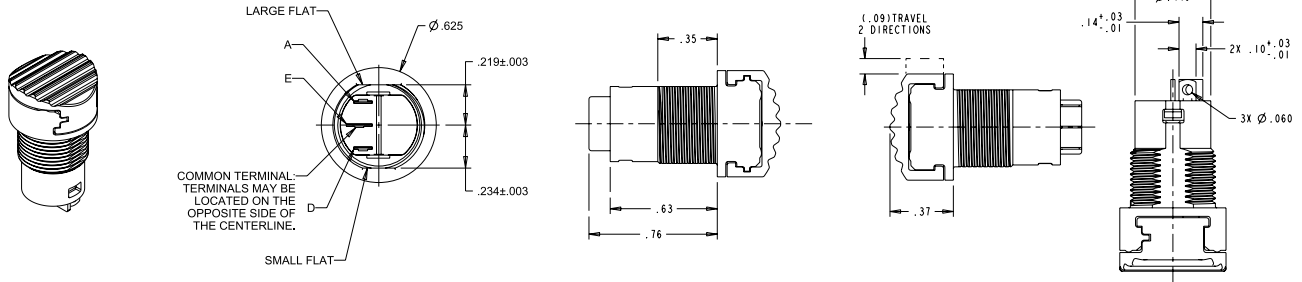

SL Slide Switch

3-Position, Center OFF
SL-2111 Series

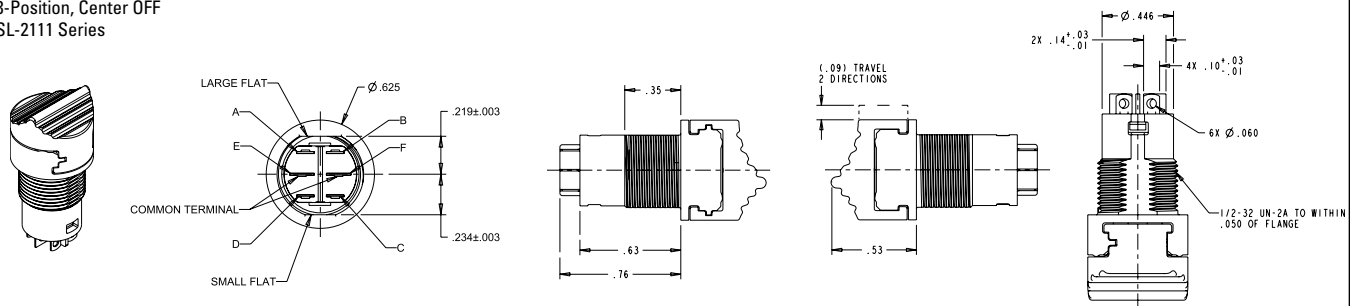

SL Slide Switch

3-Position, Center OFF
SL-2211 Series

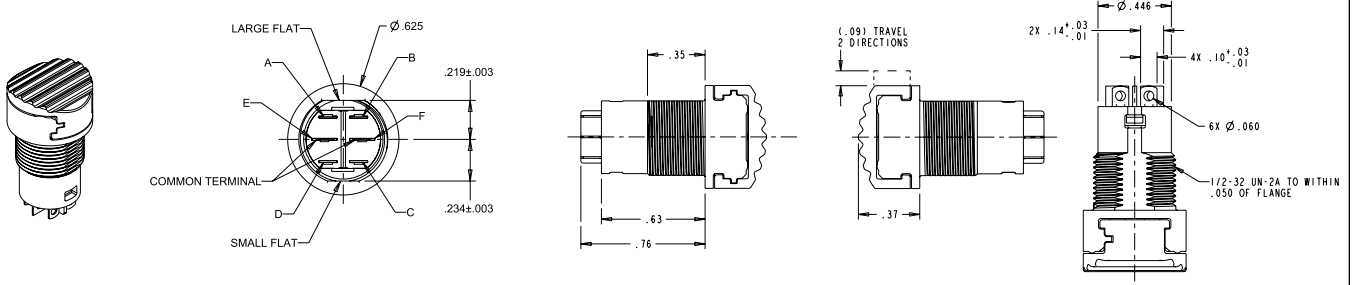

SL Slide Switch

3-Position, Center OFF
SL-2221 Series

