

PRELIMINARY DATA SHEET

SKY65088: 1.575 GHz GPS Low Noise Amplifier

Applications

- GPS radio receivers

Features

- Small signal gain: 16 dB
- Low Noise Figure: 1.0 dB
- IIP3: 0 dBm
- Minimal number of external components required
- Power shutdown mode
- IP1dB: -16 dBm
- Input/output impedance internally matched to 50 Ω
- Single DC supply: 1.8 to 3.6 V
- Small, QFN (6-pin, 1.5 x 2 mm) package (MSL3, 250 °C per JEDEC J-STD-020)

NEW



Skyworks Green™ products are RoHS (Restriction of Hazardous Substances)-compliant, conform to the EIA/EICTA/JEITA Joint Industry Guide (JIG) Level A guidelines, are halogen free according to IEC-61249-2-21, and contain <1,000 ppm antimony trioxide in polymeric materials.

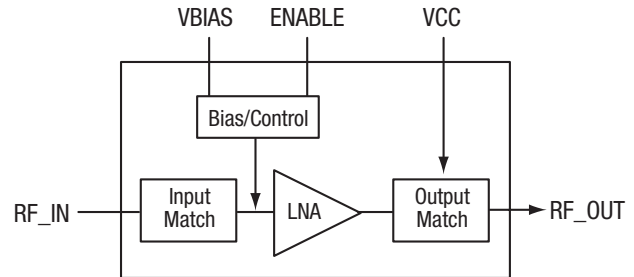

Figure 1. SKY65088 Block Diagram

Description

The SKY65088 is a Microwave Monolithic Integrated Circuit (MMIC) Global Positioning System (GPS) Low Noise Amplifier (LNA). The device has superior Noise Figure (NF), excellent gain, and a high 1 dB Input Compression Point (IP1dB).

The SKY65088 is optimized to operate at 1.575 GHz, which makes it ideal for GPS radio receiver applications.

The device is fabricated using Skyworks high reliability SiGe CMOS technology. The LNA uses Surface Mount Technology (SMT) in the form of a 1.5 x 2.0 mm Quad Flat No-Lead (QFN) package, which allows for a highly manufacturable and low-cost solution.

A functional block diagram is shown in Figure 1. The pin configuration and package are shown in Figure 2. Signal pin assignments and functional pin descriptions are provided in Table 1.

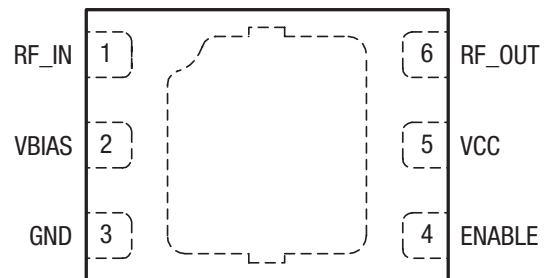

Figure 2. SKY65088 Pinout – 6-Pin QFN (Top View)

Table 1. SKY65088 Signal Descriptions

Pin #	Name	Description	Pin #	Name	Description
1	RF_IN	RF input	4	ENABLE	Power on/off control
2	VBIAS	Bias voltage	5	VCC	Source voltage
3	GND	Ground	6	RF_OUT	RF output

Table 2. SKY65088 Absolute Maximum Ratings

Parameter	Symbol	Minimum	Typical	Maximum	Units
RF input power	P _{IN}			0	dBm
Supply voltage	V _{CC}	1.8	3.0	3.6	V
Supply current	I _{CC}		6	12	mA
Storage temperature	T _{STG}	-65		125	°C
Junction temperature	T _J			150	°C

Note: Exposure to maximum rating conditions for extended periods may reduce device reliability. There is no damage to device with only one parameter set at the limit and all other parameters set at or below their nominal value. Exceeding any of the limits listed here may result in permanent damage to the device.

CAUTION: Although this device is designed to be as robust as possible, Electrostatic Discharge (ESD) can damage this device. This device must be protected at all times from ESD. Static charges may easily produce potentials of several kilovolts on the human body or equipment, which can discharge without detection. Industry-standard ESD precautions should be used at all times.

Table 3. SKY65088 Recommended Operating Conditions

Parameter	Symbol	Minimum	Typical	Maximum	Units
RF input power	P _{IN}		-85		dBm
Supply voltage (measured at terminals of Evaluation Board)	V _{CC}	1.8	3.0		V
Frequency range	f	1500	1575	1600	MHz
Case operating temperature	T _C	-40		+85	°C

Electrical and Mechanical Specifications

The absolute maximum ratings of the SKY65088 are provided in Table 2. The recommended operating conditions are specified in Table 3 and electrical specifications are provided in Tables 4 and 5.

Performance characteristics for the SKY65088 are illustrated in Figures 3 through 11.

Table 4. SKY65088 Electrical Specifications (Note 1)
(V_{CC} = 3 V, T_C = +25 °C, Test Frequency = 1.575 GHz, Unless Otherwise Noted)

Parameter	Symbol	Test Condition	Min	Typical	Max	Units
Small signal gain	G			16		dB
1 dB Input Compression Point	IP1dB			-16		dBm
Noise Figure	NF			1.0		dB
Third Order Input Intercept Point	IIP3			0		dBm
Isolation	S ₁₂			30		dB
Input return loss	S ₁₁			9.4		dB
Output return loss	S ₂₂			18.1		dB
Current consumption	I _{DD}			6.5		mA

Note 1: Performance is guaranteed only under the conditions listed in this Table and is not guaranteed over the full operating or storage temperature ranges. Operation at elevated temperatures may reduce reliability of the device.

Table 5. SKY65088 Electrical Specifications (Note 1)
(V_{CC} = 2.8 V, T_C = +25 °C, Test Frequency = 1.575 GHz, Unless Otherwise Noted)

Parameter	Symbol	Test Condition	Min	Typical	Max	Units
Small signal gain	G			15.9		dB
1 dB Input Compression Point	IP1dB			-16.75		dBm
Noise Figure	NF			1.0		dB
Third Order Input Intercept Point	IIP3			+1.6		dBm
Isolation	S ₁₂			30		dB
Input return loss	S ₁₁			9.45		dB
Output return loss	S ₂₂			17.75		dB
Current consumption	I _{DD}			6.5		mA

Note 1: Performance is guaranteed only under the conditions listed in this Table and is not guaranteed over the full operating or storage temperature ranges. Operation at elevated temperatures may reduce reliability of the device.

Typical Performance Characteristics

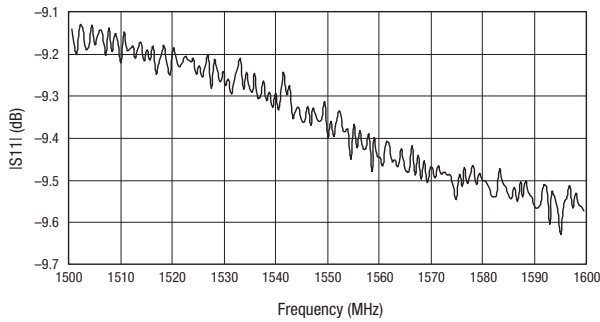

Figure 3. Input Return Loss vs Frequency (Vcc = 3.0 V)

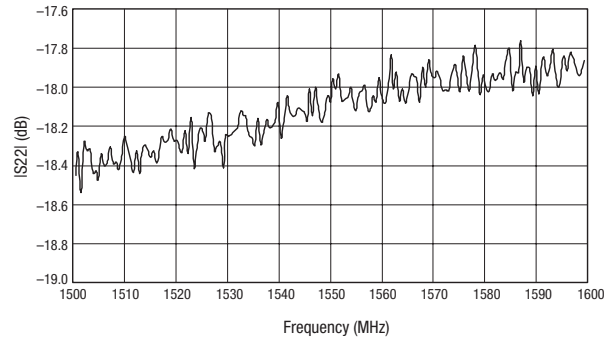

Figure 4. Output Return Loss vs Frequency (Vcc = 3.0 V)

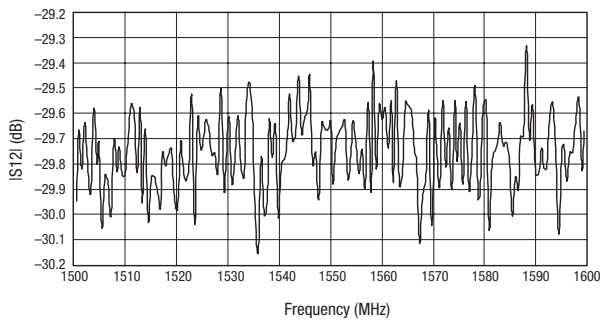

Figure 5. Reverse Isolation vs Frequency (Vcc = 3.0 V)

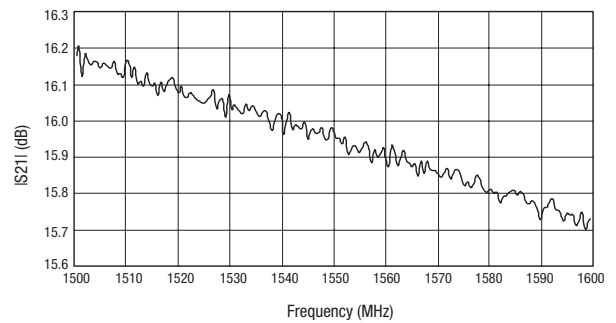

Figure 6. Small Signal Gain vs Frequency (Vcc = 3.0 V)

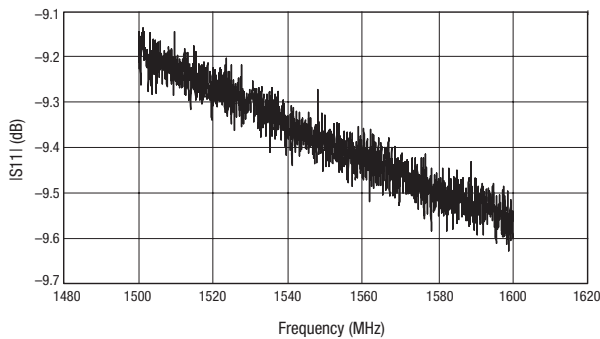

Figure 7. Input Return Loss vs Frequency (Vcc = 2.8 V)

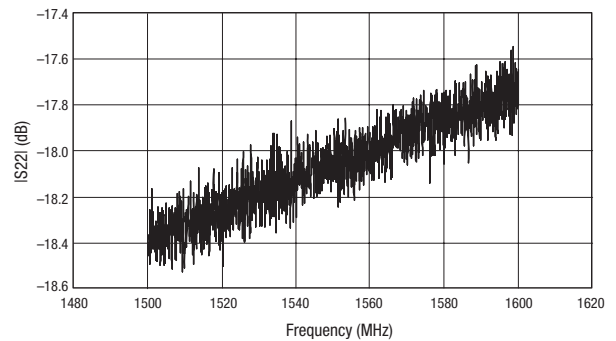

Figure 8. Output Return Loss vs Frequency (Vcc = 2.8 V)

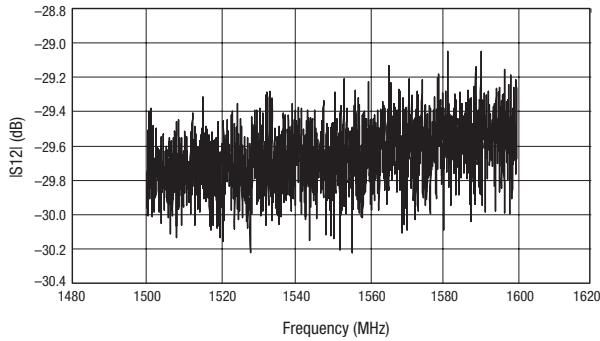

Figure 9. Reverse Isolation vs Frequency (Vcc = 2.8 V)

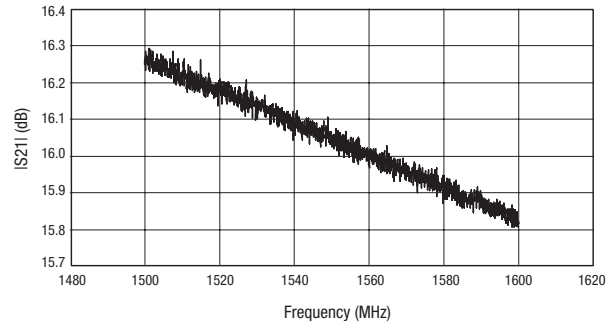

Figure 10. Small Signal Gain vs Frequency (Vcc = 2.8 V)

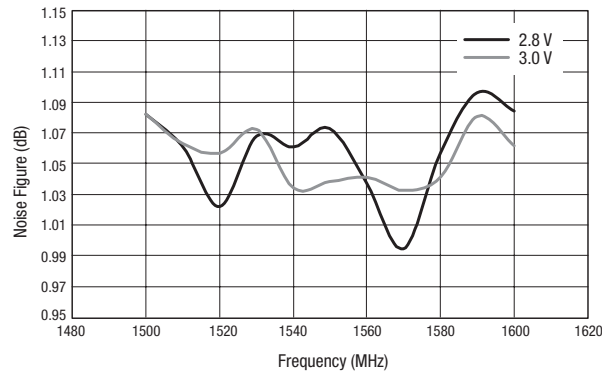

Figure 11. Noise Figure vs Frequency Over Voltage

Evaluation Board Description

The SKY65088 Evaluation Board is used to test the performance of the SKY65088 low noise amplifier. An assembly drawing for the Evaluation Board is shown in Figure 12 and the layer detail is provided in Figure 13. The Evaluation Board schematic diagram is shown in Figure 14. Table 6 provides the Bill of Materials (BOM) list for Evaluation Board components.

Package Dimensions

Package dimensions for the 6-pin QFN are shown in Figure 15, and tape and reel dimensions are provided in Figure 16.

Package and Handling Information

Since the device package is sensitive to moisture absorption, it is baked and vacuum packed before shipping. Instructions on the shipping container label regarding exposure to moisture after the

container seal is broken must be followed. Otherwise, problems related to moisture absorption may occur when the part is subjected to high temperature during solder assembly.

THE SKY65088 is rated to Moisture Sensitivity Level 3 (MSL3) at 250 °C. It can be used for lead or lead-free soldering. For additional information, refer to the Skyworks Application Note, *PCB Design and SMT Assembly/Rework Guidelines for MCM-L Packages*, document number 101752.

Care must be taken when attaching this product, whether it is done manually or in a production solder reflow environment. Production quantities of this product are shipped in a standard tape and reel format. For packaging details, refer to the Skyworks Application Note, *Discrete Devices and IC Switch/Attenuators Tape and Reel Package Orientation*, document number 200083.

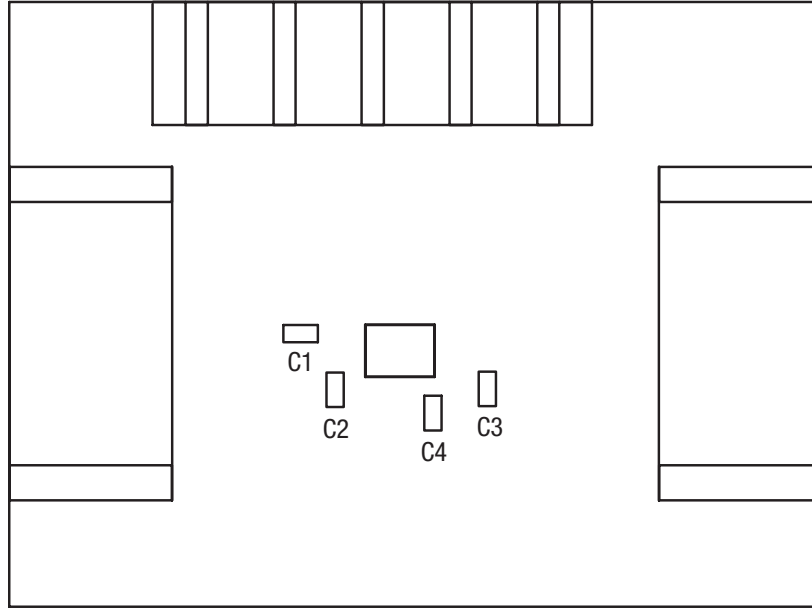

S1727

Figure 12. SKY65088 Evaluation Board Assembly Diagram

*** TBD ***

Figure 13. SKY65088 Evaluation Board Layer Detail

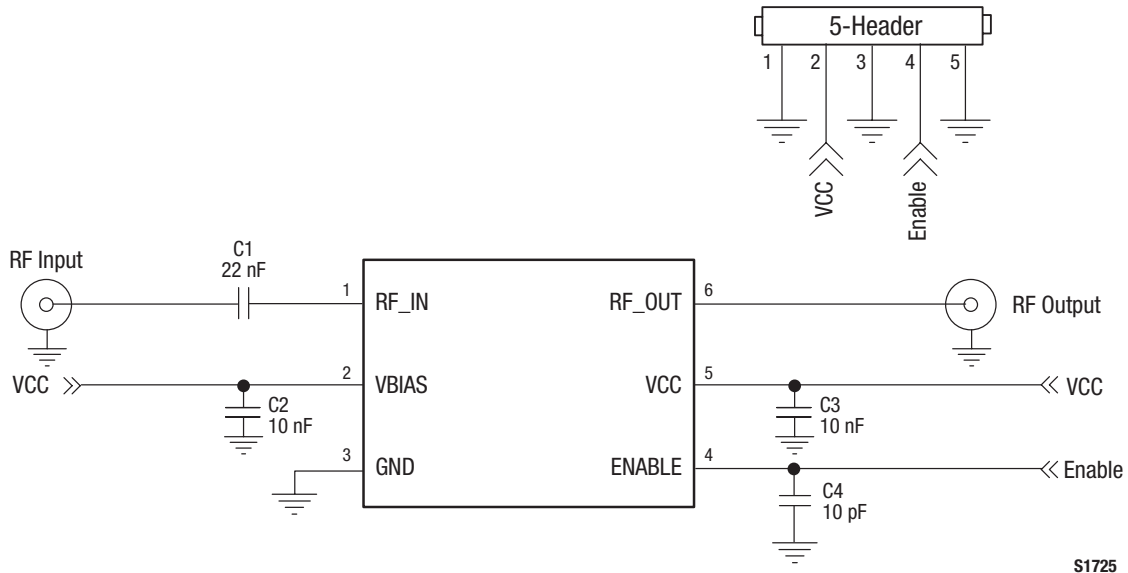
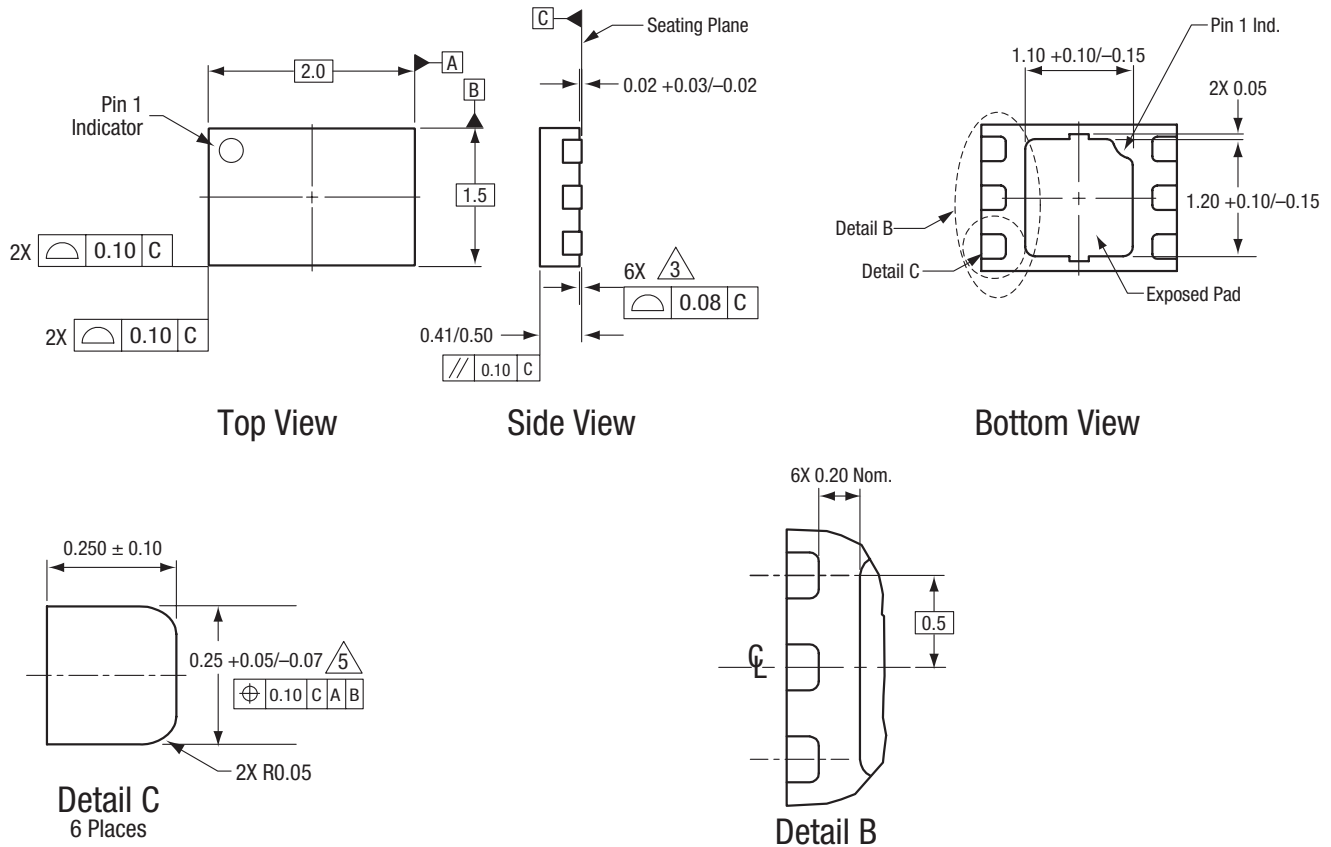

Figure 14. SKY65088 Evaluation Board Schematic

Table 6. SKY65088 (QFN Package) Evaluation Board Bill of Materials

Component	Size	Value	Vendor	Part Number
C1		22 nF		
C2		10 nF		
C3		10 nF		
C4		10 pF		



All measurements are in millimeters.
 Dimensioning and tolerancing according to ASME Y14.5M-1994.
 Coplanarity applies to the exposed heat sink slug as well as the terminals.
 Plating requirement per source control drawing (SCD) 2504.
 Dimension applies to metallized terminal and is measured between 0.15 mm and 0.30 mm from terminal tip.

S1528

Figure 15. SKY65088 6-Pin QFN Package Dimensions

*** TBD ***

Figure 16. SKY65088 Tape and Reel Dimensions

Ordering Information

Model Name	Manufacturing Part Number	Evaluation Kit Part Number
SKY65088 GPS Low Noise Amplifier	SKY65088 (Pb-free package)	*** TBD ***

Copyright © 2009 Skyworks Solutions, Inc. All Rights Reserved.

Information in this document is provided in connection with Skyworks Solutions, Inc. (“Skyworks”) products or services. These materials, including the information contained herein, are provided by Skyworks as a service to its customers and may be used for informational purposes only by the customer. Skyworks assumes no responsibility for errors or omissions in these materials or the information contained herein. Skyworks may change its documentation, products, services, specifications or product descriptions at any time, without notice. Skyworks makes no commitment to update the materials or information and shall have no responsibility whatsoever for conflicts, incompatibilities, or other difficulties arising from any future changes.

No license, whether express, implied, by estoppel or otherwise, is granted to any intellectual property rights by this document. Skyworks assumes no liability for any materials, products or information provided hereunder, including the sale, distribution, reproduction or use of Skyworks products, information or materials, except as may be provided in Skyworks Terms and Conditions of Sale.

THE MATERIALS, PRODUCTS AND INFORMATION ARE PROVIDED “AS IS” WITHOUT WARRANTY OF ANY KIND, WHETHER EXPRESS, IMPLIED, STATUTORY, OR OTHERWISE, INCLUDING FITNESS FOR A PARTICULAR PURPOSE OR USE, MERCHANTABILITY, PERFORMANCE, QUALITY OR NON-INFRINGEMENT OF ANY INTELLECTUAL PROPERTY RIGHT; ALL SUCH WARRANTIES ARE HEREBY EXPRESSLY DISCLAIMED. SKYWORKS DOES NOT WARRANT THE ACCURACY OR COMPLETENESS OF THE INFORMATION, TEXT, GRAPHICS OR OTHER ITEMS CONTAINED WITHIN THESE MATERIALS. SKYWORKS SHALL NOT BE LIABLE FOR ANY DAMAGES, INCLUDING BUT NOT LIMITED TO ANY SPECIAL, INDIRECT, INCIDENTAL, STATUTORY, OR CONSEQUENTIAL DAMAGES, INCLUDING WITHOUT LIMITATION, LOST REVENUES OR LOST PROFITS THAT MAY RESULT FROM THE USE OF THE MATERIALS OR INFORMATION, WHETHER OR NOT THE RECIPIENT OF MATERIALS HAS BEEN ADVISED OF THE POSSIBILITY OF SUCH DAMAGE.

Skyworks products are not intended for use in medical, lifesaving or life-sustaining applications, or other equipment in which the failure of the Skyworks products could lead to personal injury, death, physical or environmental damage. Skyworks customers using or selling Skyworks products for use in such applications do so at their own risk and agree to fully indemnify Skyworks for any damages resulting from such improper use or sale.

Customers are responsible for their products and applications using Skyworks products, which may deviate from published specifications as a result of design defects, errors, or operation of products outside of published parameters or design specifications. Customers should include design and operating safeguards to minimize these and other risks. Skyworks assumes no liability for applications assistance, customer product design, or damage to any equipment resulting from the use of Skyworks products outside of stated published specifications or parameters.

Skyworks, the Skyworks symbol, and “Breakthrough Simplicity” are trademarks or registered trademarks of Skyworks Solutions, Inc., in the United States and other countries. Third-party brands and names are for identification purposes only, and are the property of their respective owners. Additional information, including relevant terms and conditions, posted at www.skyworksinc.com, are incorporated by reference.