

# MMCX Straight Crimp Type Bulkhead Jack - Solder or Crimp Captivated Contact

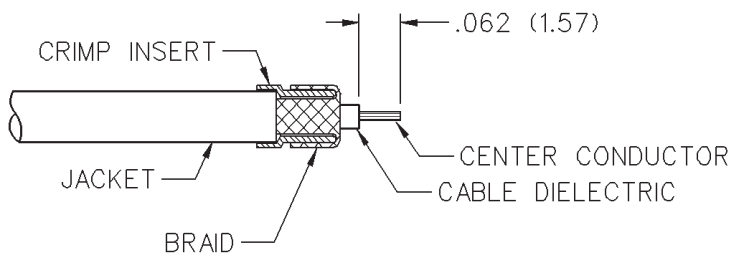

CABLE TYPE	PART NUMBER	TERMINATION
.047" Diameter Flexible Huber K01152-07 Axon P512479A Astrolab 32018 DS	135-3336-401	Crimp Insert

INCHES (MILLIMETERS)  
CUSTOMER DRAWINGS AVAILABLE UPON REQUEST

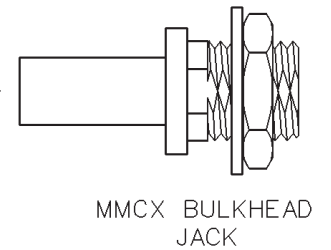
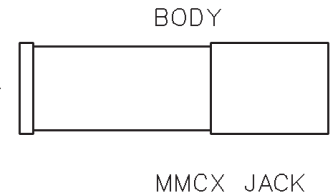
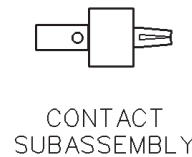
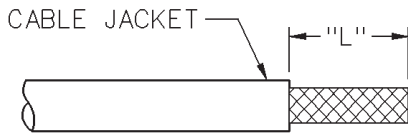
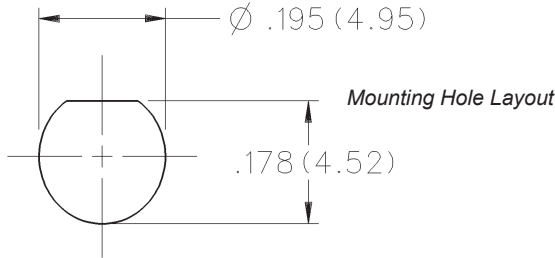
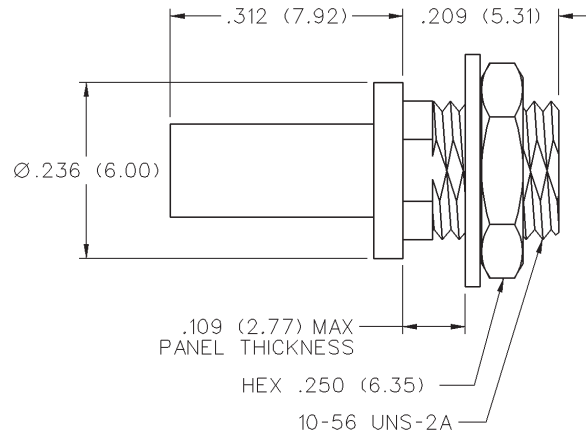

PART NUMBER	"L"	CRIMP HEX
135-3336-401	.135 (3.43)	.105 (2.67) x .250 (2.67) W

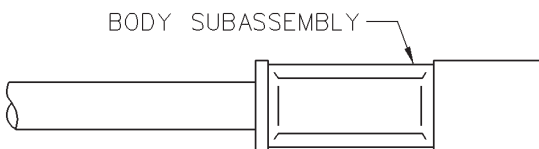
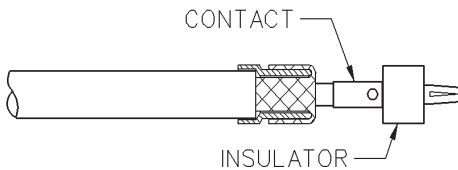

1. Identify connector parts. (3 piece parts - except bulkhead jack as shown.)
2. Strip cable jacket to dimensions shown. Do not nick braid or center conductor during strip operations.
3. Slide crimp insert over braid and against jacket, fold braid around crimp insert. Strip dielectric to dimension shown. Tin center conductor if contact will be solder attached. Do not tin center conductor if contact is to be crimp attached.
4. Assemble contact assembly onto cable as shown.  
**Solder attachment:** Solder contact to center conductor. Care should be taken that excess solder is not applied.  
**Crimp attachment:** Crimp contact to center conductor using Johnson Components™ hand tool 140-0000-952 and die set 140-0000-953. Crimp location should be centered between end of contact and cross-hole. Crimp attachment to solid center conductor cables is not recommended.
5. Slide body assembly over contact and crimp insert, then seat firmly onto contact. Crimp body using recommended crimp hex. Bulkhead jack requires 140-000-951 dieset. Maintain forward pressure on cable while crimping.

# MMCX - 50 Ohm Connectors



## Specifications

### ELECTRICAL RATINGS

**Impedance:** 50 ohms

**Frequency Range:** Connectors ..... 0-6 GHz  
 Dummy loads ..... 0-1 GHz

**VSWR:** (f = GHz)

	Straight Cabled Connectors	Right Angle Cabled Connectors
.047 dia flexible	1.20	1.14 + .07f
RG-178, RG-316, RG-316DS	1.20	1.25
.086 semi-rigid	1.15	1.15

Uncabled receptacles, dummy loads ..... N/A

**Working Voltage:** Connectors ..... 170 Vrms at sea level†  
 Dummy loads ..... N/A

**Dielectric Withstanding Voltage:** Connectors...500 Vrms at sea level†  
 Dummy loads ..... N/A

**Insulation Resistance:** 1000 megohms min

**Contact Resistance:** (milliohms maximum)

	Initial	After Environmental
Center contact (straight cabled connectors and uncabled receptacles)	5.0	8.0
Center contact (right angle cabled connectors)	5.0	15.0
Outer contact (all connectors)	1.0	1.5
Braid to body	1.5	N/A

**Corona Level:** Connectors ..... 190 volts min at 70,000 feet†  
 Dummy loads ..... N/A

**Insertion Loss:** (dB max tested at 1 GHz)

Straight cabled connectors	0.1
Right angle cabled connectors	0.2
Uncabled receptacles, dummy loads	N/A

**RF Leakage:** (dB minimum, tested at 2.5 GHz)

Flexible cable connectors	-60 dB
.086 semi-rigid	-70 dB
Dummy loads	N/A

**RF High Potential Withstanding Voltage:** (400 Vrms at 4 and 7 MHz)†  
**Power Rating (Dummy Load):** - 0.5 watt @ +25°C, derated to 0.25 watt @ +125° C

†Avoid user injury due to misapplication.  
 See safety advisory definitions inside front cover.

### MECHANICAL RATINGS

**Engagement Design:** Series MMCX

**Engagement/Disengagement Force:** 8 lbs. max axial engagement  
 1.4 lbs. min axial disengagement

**Contact Retention:** 2.0 lbs. minimum axial force  
**Cable Retention:**

	Axial Force* (pounds)	Torque (in-oz)
Connectors for .047 flexible	3.5	N/A
Connectors for RG-178	7.0	N/A
Connectors for RG-316	20.0	N/A
Connectors for RG-316DS	25.0	N/A
Connectors for .086 semi-rigid	30.0	16

\*Or cable breaking strength whichever is less.  
**Durability:** ..... 500 cycles minimum

**ENVIRONMENTAL RATINGS** (Meets or exceed the applicable paragraph of MIL-C-39012)

**Operating Temperature:** Connectors ..... - 65°C to + 165°C  
 Dummy loads ..... - 65°C to + 125°C

**Thermal Shock:** Connectors: MIL-STD-202, Method 107, Condition C, except -55°C to + 155°C (N/A dummy loads)

**Corrosion:** MIL-STD-202, Method 101, Condition B (N/A dummy loads)

**Shock:** MIL-STD-202, Method 213, Condition B (N/A dummy loads)

**Vibration:** MIL-STD-202, Method 204, Condition D (N/A dummy loads)

**Moisture Resistance:** MIL-STD-202, Method 106 (N/A dummy loads)

### MATERIAL SPECIFICATIONS

**Bodies:** Brass per QQ-B-626, gold plated\* per MIL-G-45204 .00001" min.

**Contacts:** Beryllium copper per QQ-C-530, gold plated\* per MIL-G-45204 .00003" min.

**Interface Spring:** Beryllium copper per QQ-C-530, gold plated\* per MIL-G-45204 .00003" min.

**Insulators:** PTFE fluorocarbon per ASTM D 1710 and ASTM D 1457

**Crimp Sleeves:** Copper per WW-T-799 or brass per QQ-B-626, gold plated per MIL-G-45204 .00001" min.

**Mounting Hardware:** Brass per QQ-B-626 or QQ-B-613, gold plated per MIL-G-45204 .00001" min.

\*All gold plated parts include a .00005" min nickel barrier layer.

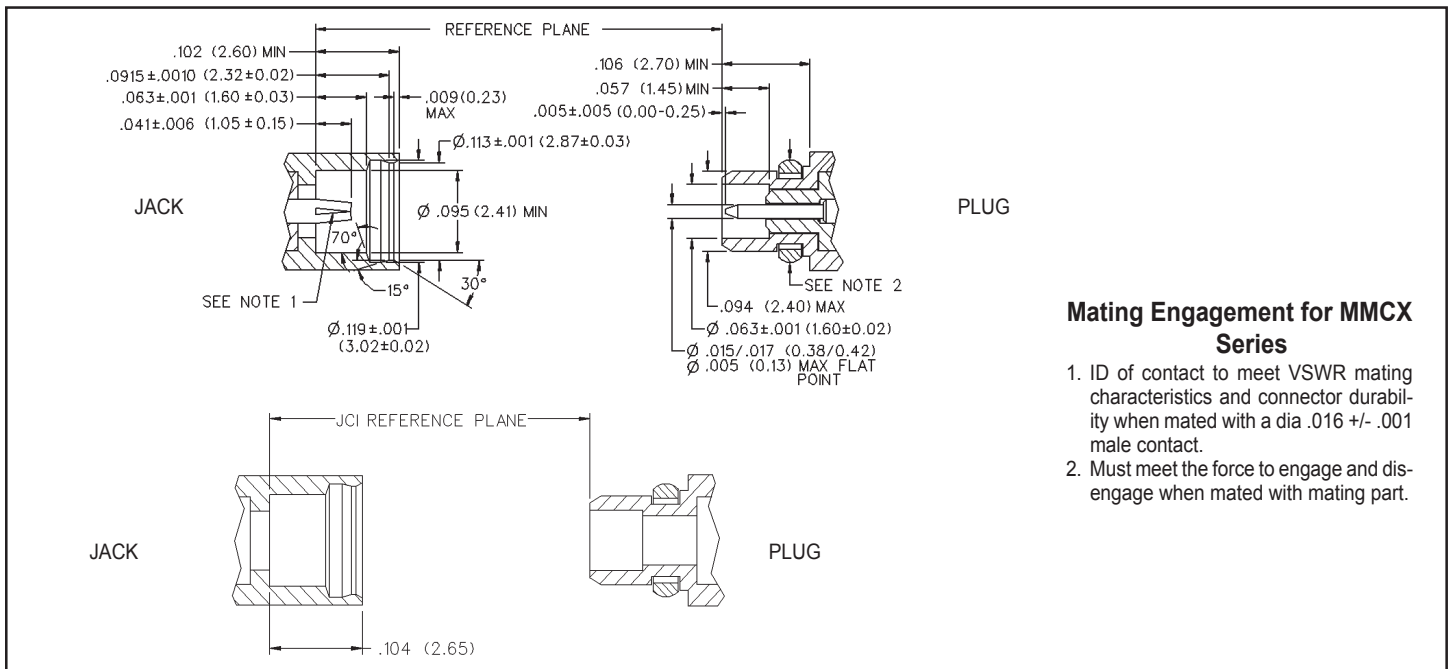

### Mating Engagement for MMCX Series

1. ID of contact to meet VSWR mating characteristics and connector durability when mated with a dia .016 +/- .001 male contact.
2. Must meet the force to engage and disengage when mated with mating part.