

HDSP-B7xZ Series

31.99 mm (1.26 inch) General Purpose 4x8 Dot Matrix
Bi-Color Alphanumeric Displays



Data Sheet



Description

These displays have a 31.99 mm (1.26 inch) character height. The devices are available in either common row anode or common row cathode configurations. The displays come in only black face paint. The Bi-color display consists of GaP Red (HER) and GaP Green colors.

These parts are subjected to Outgoing Quality Assurance (OQA) inspection with an AQL of 0.065% for functional and visual/cosmetic defects.

Devices

HDSP-	Description
B71Z	31.99 mm Black Surface Bi-Color Common Row Anode
B76Z	31.99 mm Black Surface Bi-Color Common Row Cathode

Note:

1. For details, please contact your local Avago components sales office or an authorized distributor.

Features

- **4x8 Dot matrix font**
- **X-Y stackable**
- **Pin-out**
 - 27.42 mm (1.08 in.) Dual-In-Line (DIP) leads on 2.0 mm (0.079 in.) centers
- **Choice of colors**
 - Bi-color: red and green
- **Face paint color: black**
- **Design flexibility**
 - Common row anode or common row cathode
- **Categorized for luminance**

Applications

- **Suitable for indoor use**
- **Not recommended for industrial applications, i.e. operating temperature requirements exceeding 85°C or below -35°C**
- **Extreme temperature cycling not recommended^[1]**

Package Dimensions

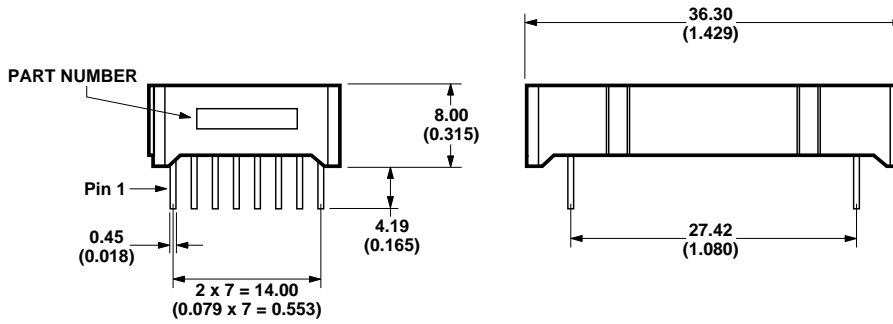
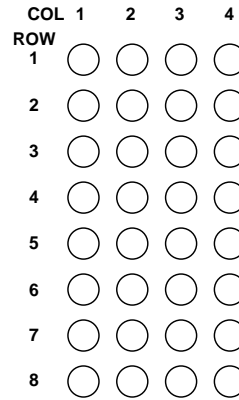
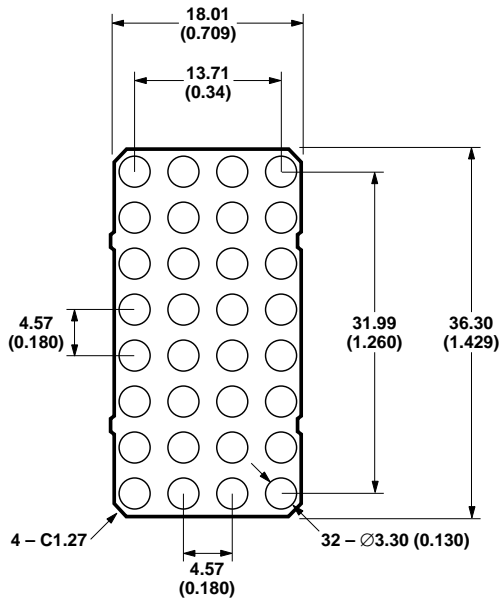

Internal Circuit Diagram

Common Row Anode – Bi-Color

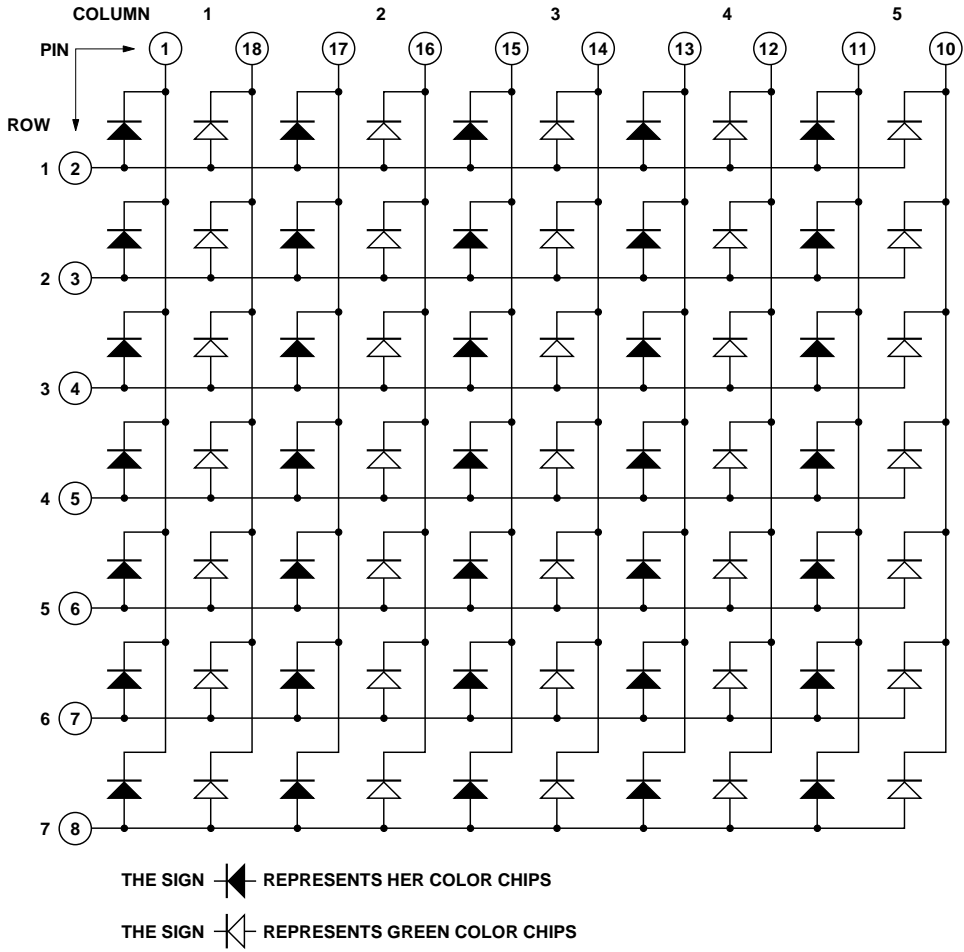

PIN	CONNECTION
1	CATHODE COLUMN 1 HER
2	CATHODE COLUMN 1 GREEN
3	CATHODE COLUMN 2 HER
4	CATHODE COLUMN 2 GREEN
5	CATHODE COLUMN 3 HER
6	CATHODE COLUMN 3 GREEN
7	CATHODE COLUMN 4 HER
8	CATHODE COLUMN 4 GREEN
9	ANODE ROW 1
10	ANODE ROW 2
11	ANODE ROW 3
12	ANODE ROW 4
13	ANODE ROW 5
14	ANODE ROW 6
15	ANODE ROW 7
16	ANODE ROW 8

Internal Circuit Diagram

Common Row Cathode – Bi-Color

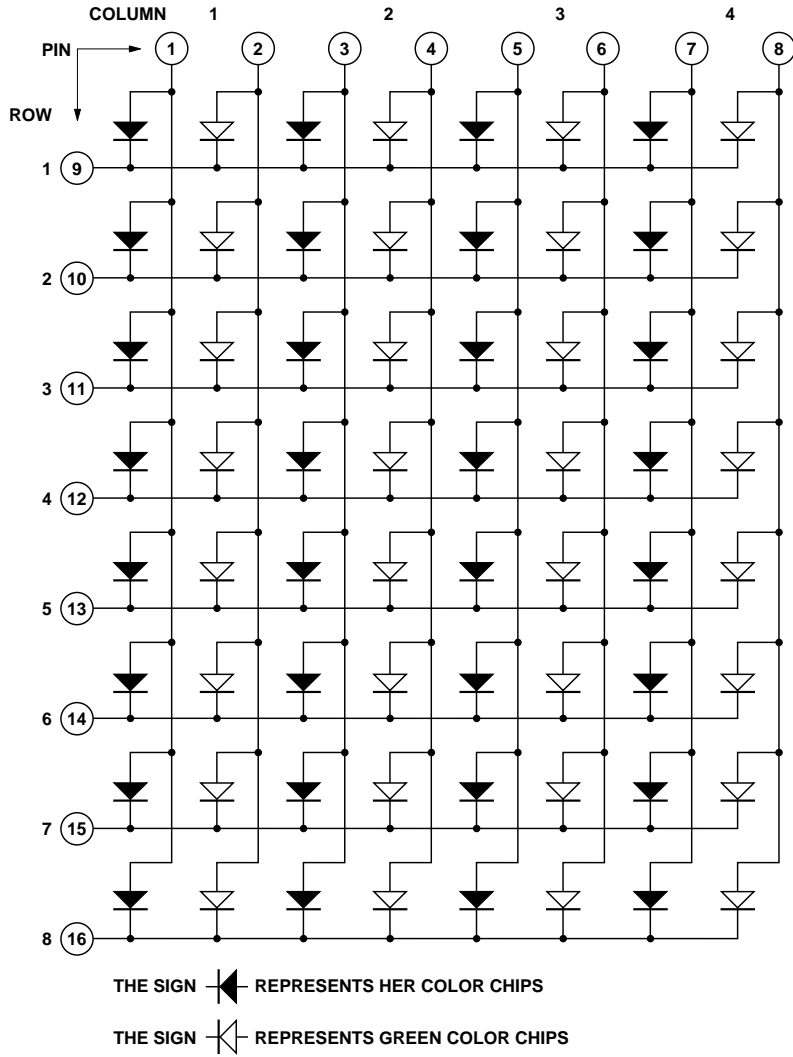

PIN	CONNECTION
1	ANODE COLUMN 1 HER
2	ANODE COLUMN 1 GREEN
3	ANODE COLUMN 2 HER
4	ANODE COLUMN 2 GREEN
5	ANODE COLUMN 3 HER
6	ANODE COLUMN 3 GREEN
7	ANODE COLUMN 4 HER
8	ANODE COLUMN 4 GREEN
9	CATHODE ROW 1
10	CATHODE ROW 2
11	CATHODE ROW 3
12	CATHODE ROW 4
13	CATHODE ROW 5
14	CATHODE ROW 6
15	CATHODE ROW 7
16	CATHODE ROW 8

Absolute Maximum Ratings at T_A = 25°C

Parameter	GaP Red HDSP-B71Z/B76Z	GaP Green HDSP-B71Z/B76Z	Units
Average Power per Dot ^[1]	36	36	mW
Peak Forward Current per Dot ^[1] (1/8 Duty Cycle at 10 KHz)	100	100	mA
Average Forward Current per Dot	13 ^[1,2]	13 ^[1,2]	mA
Reverse Voltage per Dot	3	3	V
Operating Temperature	-35 to +85	-35 to +85	°C
Storage Temperature	-35 to +85	-35 to +85	°C
Wave Soldering Temperature for 3 seconds ^[3] (2 mm [0.078 in.] below Body)	250	250	°C

Notes:

1. Do not exceed maximum average current per dot.
2. Derate above 25°C at 0.17 mA/°C.
3. Not recommended to be soldered more than 2 times. Minimum interval between solderings is 15 minutes.
Total soldering time not to exceed 3 seconds.

Optical/Electrical Characteristics at T_A = 25 °C

GaP Red

Devices HDSP-	Parameter	Symbol	Min.	Typ.	Max.	Units	Test Conditions
B71Z B76Z	Luminous Intensity/Dot (Digit Average) ^[1]	I _V		2.3		mcd	I _{FP} = 40 mA, 1/8 Duty Factor
	Peak Wavelength	λ _{peak}		632		nm	I _F = 20 mA
	Dominant Wavelength ^[2]	λ _d		622		nm	I _F = 20 mA
	Forward Voltage	V _F		2.1	2.6	V	I _F = 20 mA
	Reverse Voltage ^[3]	V _R	3.0			V	I _R = 100 μA
	Luminous Intensity Matching Ratio	I _{V-m}			2:1		I _{FP} = 40 mA, 1/8 Duty Factor

GaP Green

Devices HDSP-	Parameter	Symbol	Min.	Typ.	Max.	Units	Test Conditions
B71Z B76Z	Luminous Intensity/Dot (Digit Average) ^[1]	I _V		3.3		mcd	I _{FP} = 40 mA, 1/8 Duty Factor
	Peak Wavelength	λ _{peak}		568		nm	I _F = 20 mA
	Dominant Wavelength ^[2]	λ _d		573		nm	I _F = 20 mA
	Forward Voltage	V _F		2.3	2.6	V	I _F = 20 mA
	Reverse Voltage ^[3]	V _R	3.0			V	I _R = 100 μA
	Luminous Intensity Matching Ratio	I _{V-m}			2:1		I _{FP} = 40 mA, 1/8 Duty Factor

Bi-Color

Devices HDSP-	Parameter	Symbol	Min.	Typ.	Max.	Units	Test Conditions
B71Z B76Z	Luminance/Dot (Digit Average) ^[1]	I _V	124.1	185	372	Cd/m ²	I _{FP} = 40 mA, 1/8 Duty Factor

Notes:

1. The digits are categorized for luminance. The luminance category is designated by a letter on the side of the package.
2. The dominant wavelength, λ_d, is derived from the CIE chromaticity diagram and represents the single wavelength which defines the color of the device.
3. Typical specification for reference only. Do not exceed absolute maximum ratings.

Bi-Color (Cd/m² at I_{FP} = 40 mA, 1/8 Duty Cycle)

Bin Name	Min. ^[2]	Max. ^[2]
H	124.1	149
I	149.1	179
J	179.1	215
K	215.1	258
L	258.1	310
M	310.1	372

Hue Grade

Coordinate	Bin					
	6	7	8	9	10	11
X	0.562-0.573	0.572-0.583	0.582-0.593	0.592-0.603	0.602-0.613	0.612-0.623
Y	0.425-0.436	0.415-0.426	0.405-0.416	0.395-0.406	0.385-0.396	0.375-0.386

Notes:

1. Hue categories are established for classification of products. Products may not be available in all bin categories.
2. Tolerance for each intensity bin limit is $\pm 10\%$.

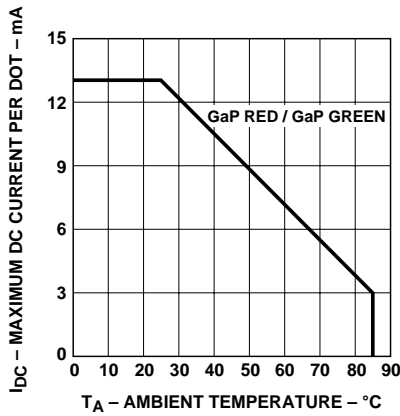

Figure 1. Maximum allowable average current per dot vs. ambient temperature.

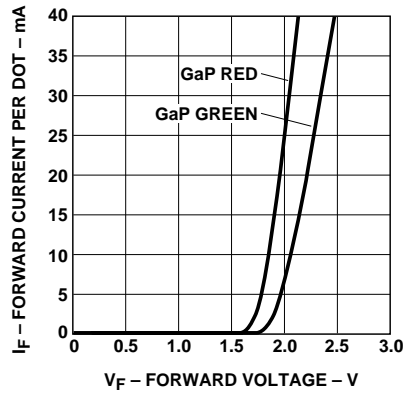

Figure 2. Forward current vs. forward voltage.

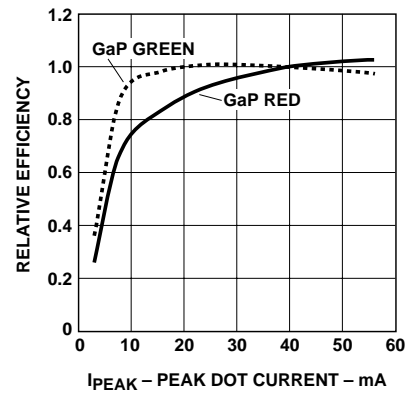

Figure 3. Relative efficiency (luminous intensity per unit dot) vs. peak current per dot.

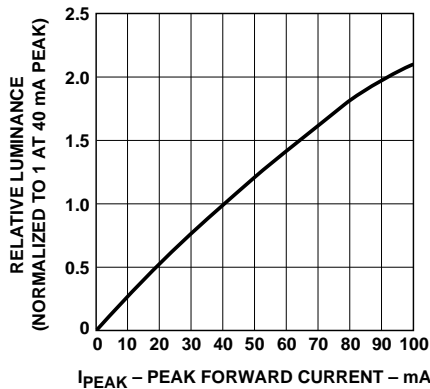

Figure 4. Relative luminance vs. peak forward current.

Contrast Enhancement

For information on contrast enhancement, please see Application Note 1015.

Soldering/Cleaning

Cleaning agents from the ketone family (acetone, methyl ethyl ketone, etc.) and from the chlorinated hydrocarbon family (methylene chloride, trichloroethylene, carbon tetrachloride, etc.) are not recommended for cleaning LED parts. All of these various solvents attack or dissolve the encapsulating epoxies used to form the package of plastic LED parts.

For information on soldering LEDs, please refer to Application Note 1027.

Device Reliability

For reliability information, please see the reliability data sheet *31.99 mm General Purpose 4 x 8 Dot Matrix Alphanumeric Displays*.

For product information and a complete list of distributors, please go to our website: www.avagotech.com

Avago, Avago Technologies, and the A logo are trademarks of Avago Technologies Limited in the United States and other countries. Data subject to change. Copyright © 2006 Avago Technologies Limited. All rights reserved. Obsoletes 5988-1745EN 5988-5216EN June 24, 2006

AVAGO
TECHNOLOGIES