

10 Watt MMDS Packaged Amplifier

TGA2924-SD/SG



Key Features

- 2.6 GHz Application Frequency Range
- 12 dB Nominal Gain
- 40 dBm Nominal Psat
- 2.5% EVM at 30 dBm output power
- Internally Partially Matched
- IMD3 -45 dBc @ 28 dBm SCL, Typical
- Bias Conditions: 8 V @ 1.2 A (Quiescent)
- 0.5 μm HFET Technology
- 2 lead Cu-alloy base package

Primary Applications

- MMDS Pt-Pt and Pt-Multi Pt Radio
- S-Band Power Amplifiers

Product Description

The TGA2924-SD HPA provides 12 dB of gain, 10 W of output power at 2.6 GHz and 2.5% EVM at 30 dBm output power. The device is ideally suited for high linearity, high power wireless data applications such as MMDS Point-to-Point or Point-to-Multi-Point radios. The package has a high thermal conductivity copper alloy base. Internal partial matching simplifies system board layout by requiring a minimum of external components.

Lead-Free & RoHS compliant.

Evaluation Boards are available.

Fixtured Measured Performance

Bias Conditions: $V_d = 8\text{ V}$, $I_{dq} = 1.2\text{ A}$

Performance data taken in a 2.6 GHz application circuit

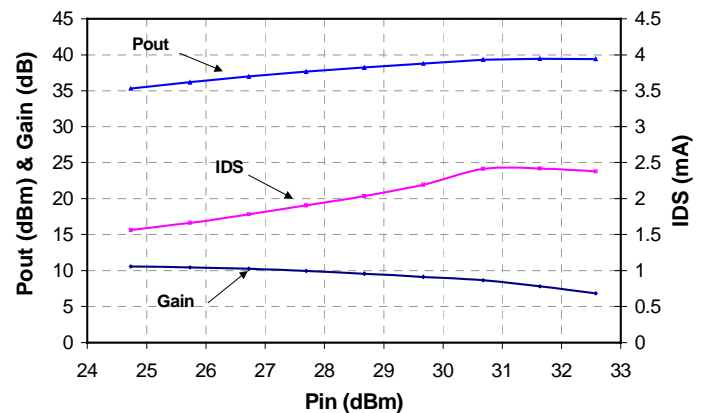
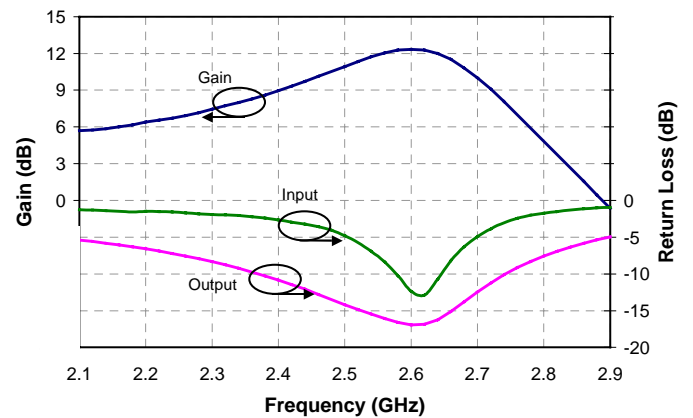

Note: This device is early in the characterization process prior to finalizing all electrical specifications. Specifications are subject to change without notice.

TABLE I
MAXIMUM RATINGS 1/

Symbol	Parameter	Value	Notes
V _d	Drain Supply Voltage	10 V	<u>2/</u>
V _g	Gate Supply Voltage Range	0 V to -5 V	
I _{dq}	Drain Supply Current (Quiescent)	4 A	<u>2/</u>
I _g	Gate Current	39 mA	
P _{IN}	Input Continuous Wave Power	39 dBm	<u>2/</u>
P _D	Power Dissipation	11.2 W	<u>2/</u> , <u>3/</u>
T _{CH}	Operating Channel Temperature	175 °C	4/
T _M	Mounting Temperature (30 Seconds)	260 °C	
T _{STG}	Storage Temperature	-65 to 150 °C	

1/ These ratings represent the maximum operable values for this device.

2/ Combinations of supply voltage, supply current, input power, and output power shall not exceed P_D.

3/ When operated at this bias condition with a base plate temperature of 85 °C, the MTTF life is 2 E+8 hours.

4/ Junction operating temperature will directly affect the device median time to failure (T_M).

For maximum life, it is recommended that junction temperatures be maintained at the

TABLE II
RF CHARACTERIZATION TABLE
($T_A = 25^\circ\text{C}$, Nominal)
($V_d = 8\text{ V}$, $I_{dq} = 1.2\text{ A}$)

SYMBOL	PARAMETER	TEST CONDITION	TYPICAL	UNITS
Gain	Small Signal Gain	$f = 2.6\text{ GHz}$	12	dB
IRL	Input Return Loss	$f = 2.6\text{ GHz}$	10	dB
ORL	Output Return Loss	$f = 2.6\text{ GHz}$	10	dB
Psat	Saturated Output Power		40	dBm

TABLE III
THERMAL INFORMATION

Parameter	Test Conditions	T_{CH} ($^\circ\text{C}$)	$R_{\theta JC}$ ($^\circ\text{C/W}$)	T_M (HRS)
$R_{\theta JC}$ Thermal Resistance (channel to backside of package)	$V_d = 8\text{ V}$ $I_D = 1.2\text{ A}$ $P_{diss} = 9.6\text{ W}$	162	8	$7.7\text{ E}+8$

Note: Package backside SnPb soldered to carrier at 85°C baseplate temperature. At saturated output power, the DC power consumption is 20W with 10W RF power delivered to the load and 10W dissipated. Adding the 1W RF input power results in 11W total power dissipation and a maximum channel temperature of 173°C at 85°C baseplate temperature.

Measured Fixtured Data
Application Circuit tuned to 2.6 GHz

Bias Conditions: $V_d = 8\text{ V}$, $I_{dq} = 1.2\text{ A}$

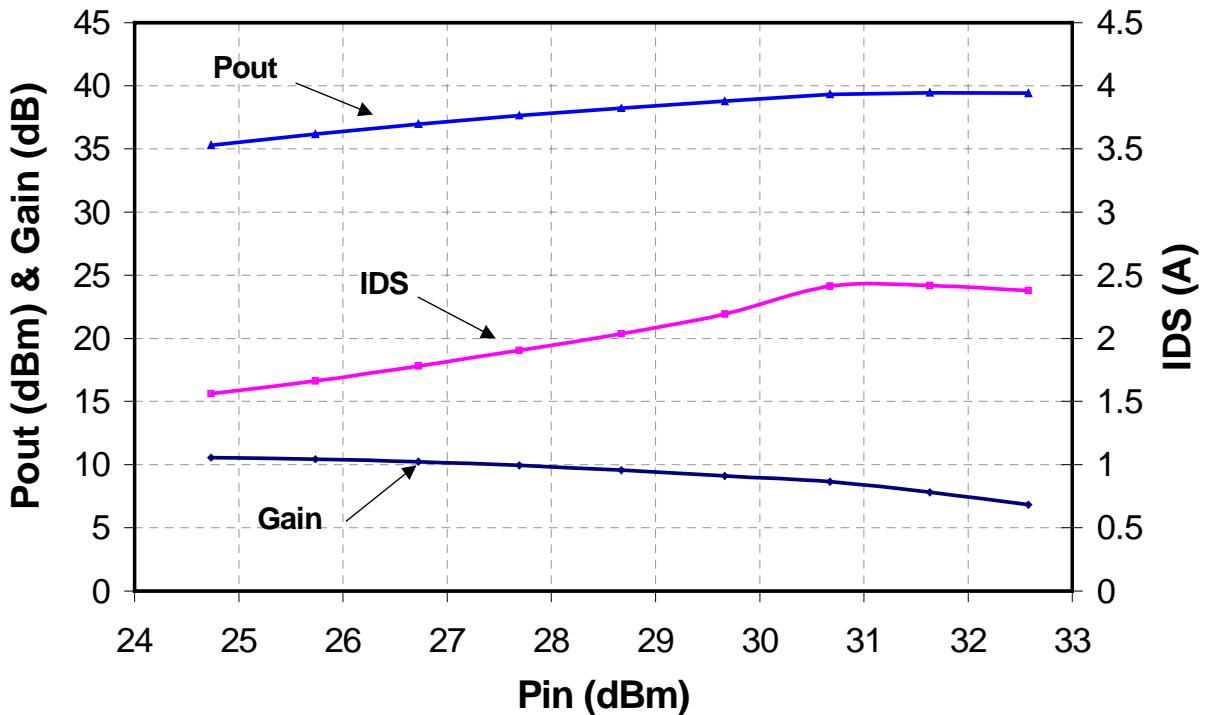
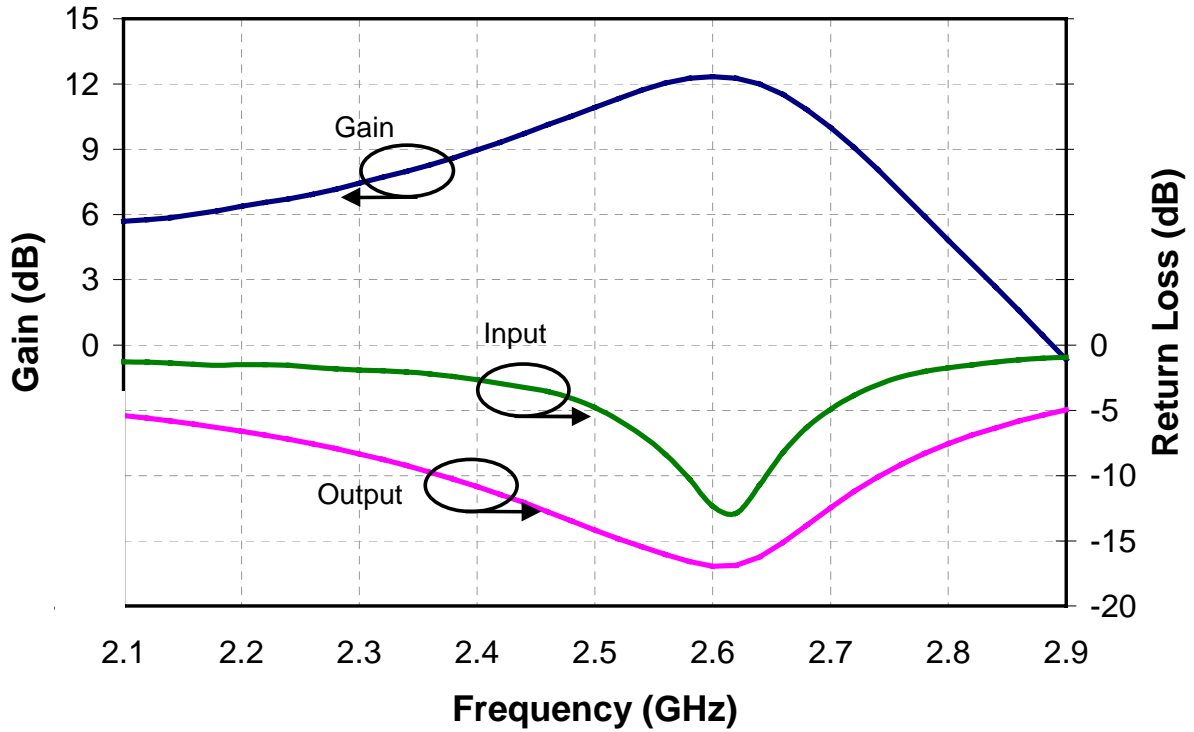

Measured Fixtured Data
Application Circuit tuned to 2.6 GHz

Bias Conditions: $V_d = 8\text{ V}$, $I_{dq} = 1.2\text{ A}$

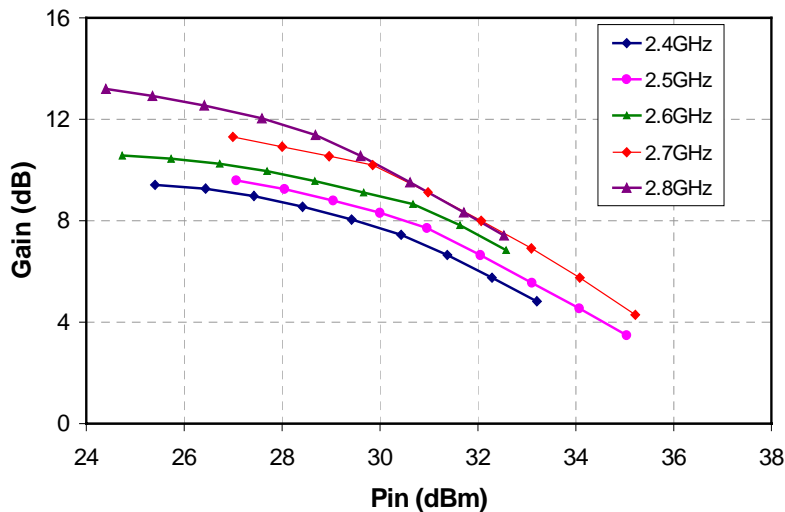
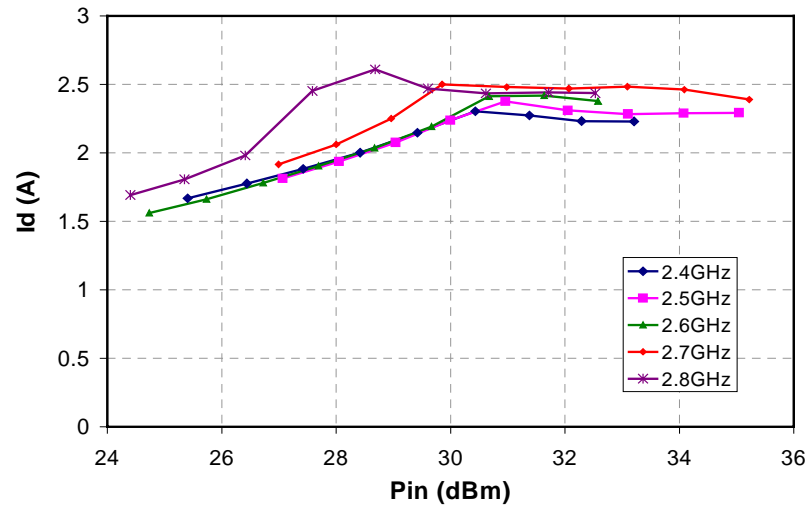
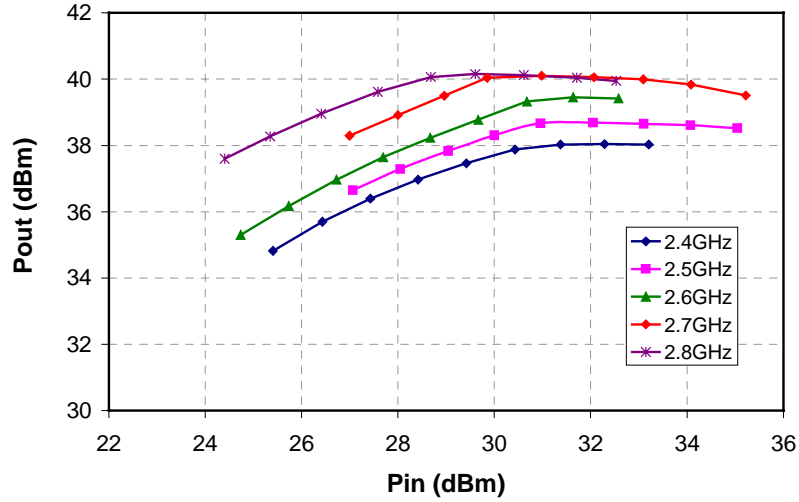

Measured Fixtured Data
Application Circuit tuned to 2.6 GHz

Bias Conditions: $V_d = 8\text{ V}$, $I_{dq} = 1.2\text{ A}$

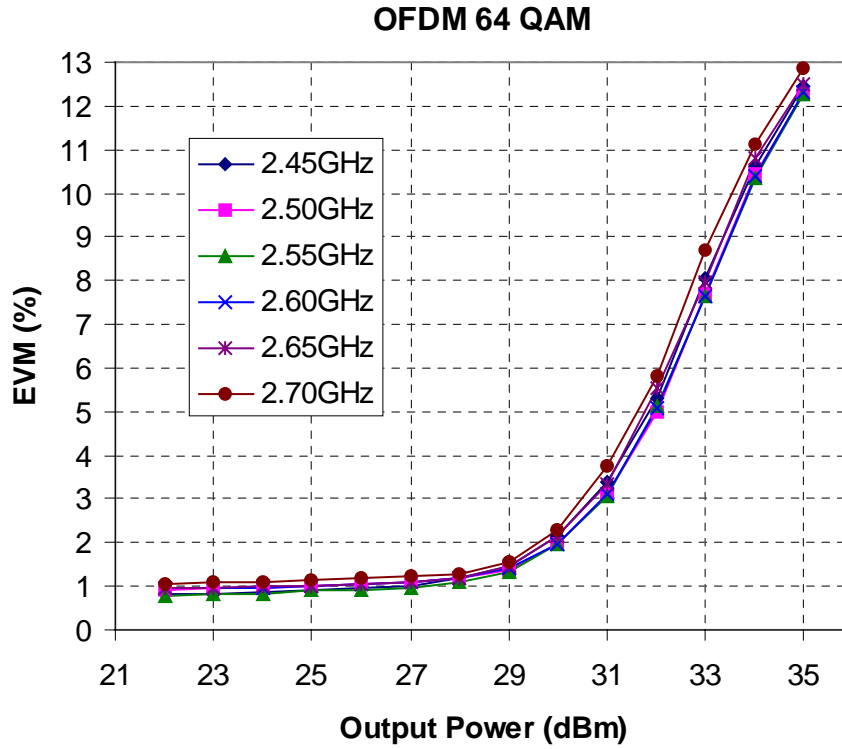

Measured Fixtured Data
Application Circuit tuned to 2.6 GHz

Bias Conditions: $V_d = 8\text{ V}$, $I_{dq} = 1.2\text{ A}$

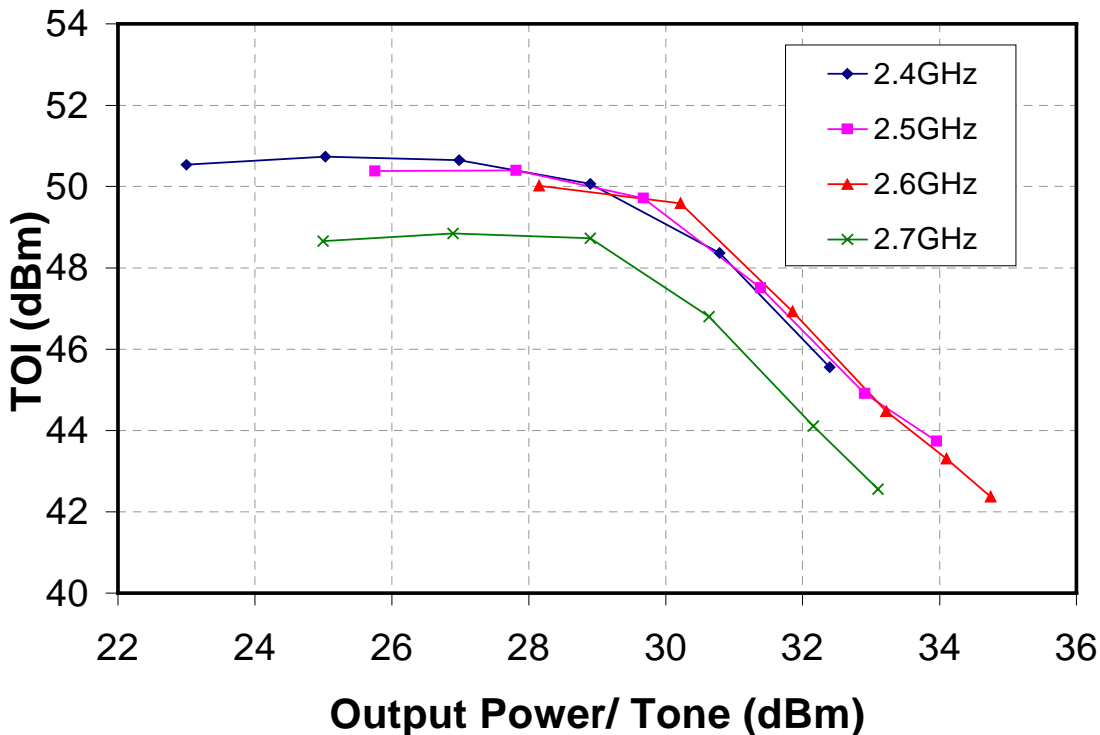
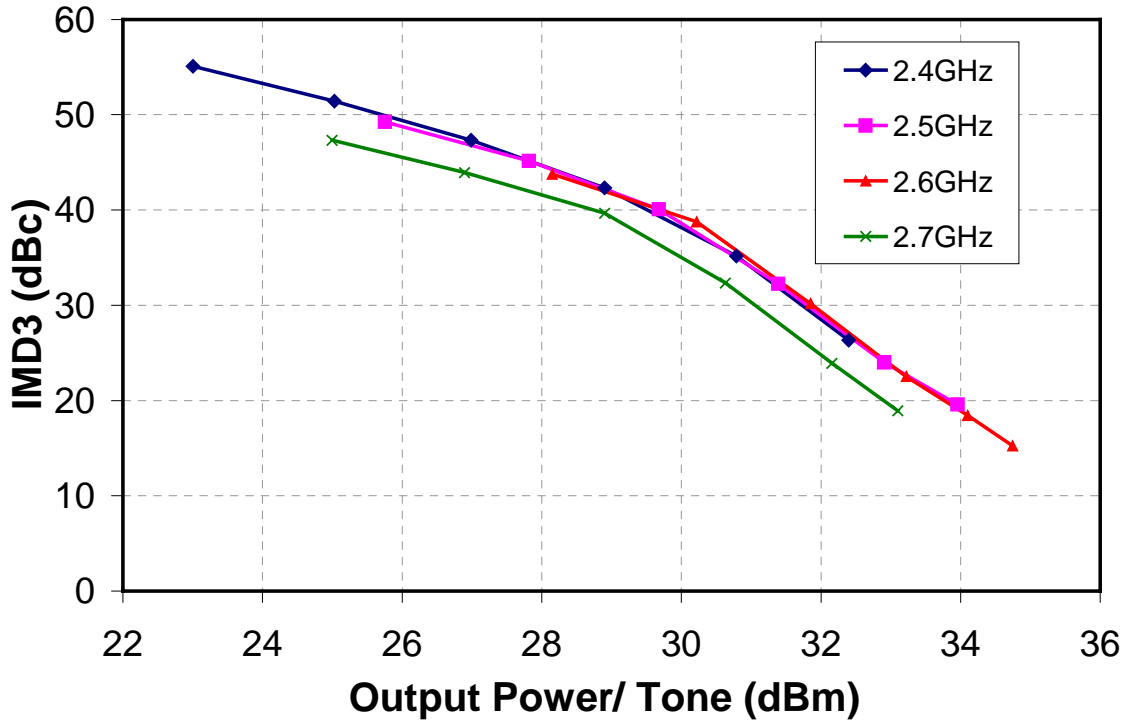

Mechanical Drawing TGA2924-EPU - SD

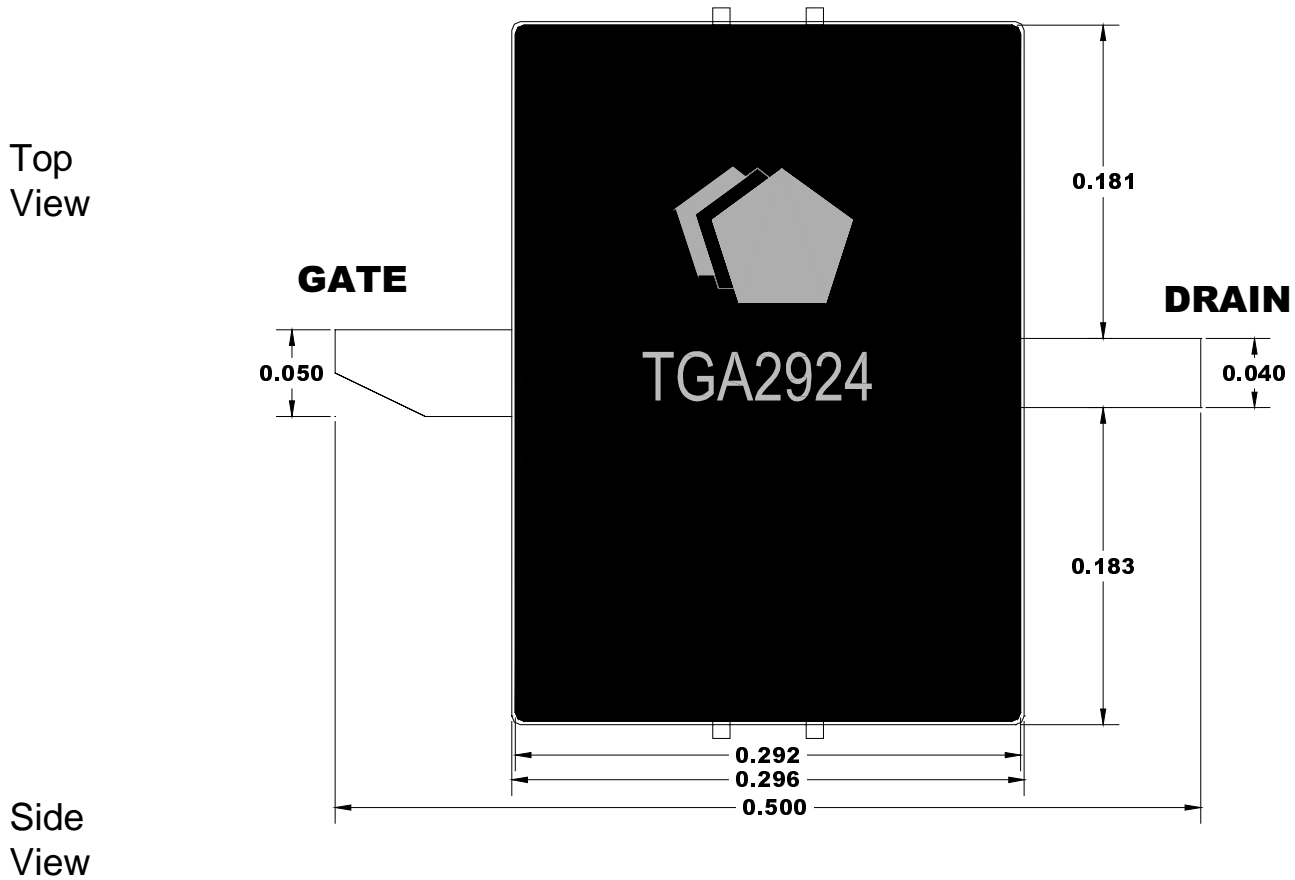

Note: All dimensions are in inches with ± 5 mil tolerance

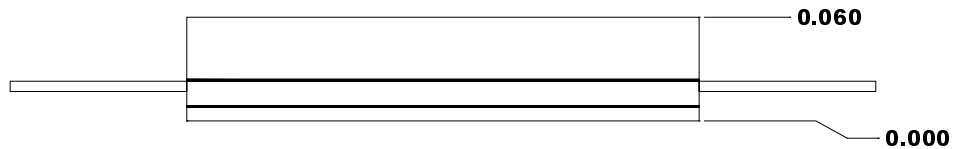

Bias Procedure

1. Ensure no RF power is applied to the device.
2. Pinch off device by setting V_g to $-3V$.
3. Increase V_d to 8.0V while monitoring drain current.
4. Increase V_g until drain current reaches 1.2A
5. Apply RF power.

GaAs MMIC devices are susceptible to damage from Electrostatic Discharge. Proper precautions should be observed during handling, assembly and test.

2.6 GHz Application Circuit Schematic

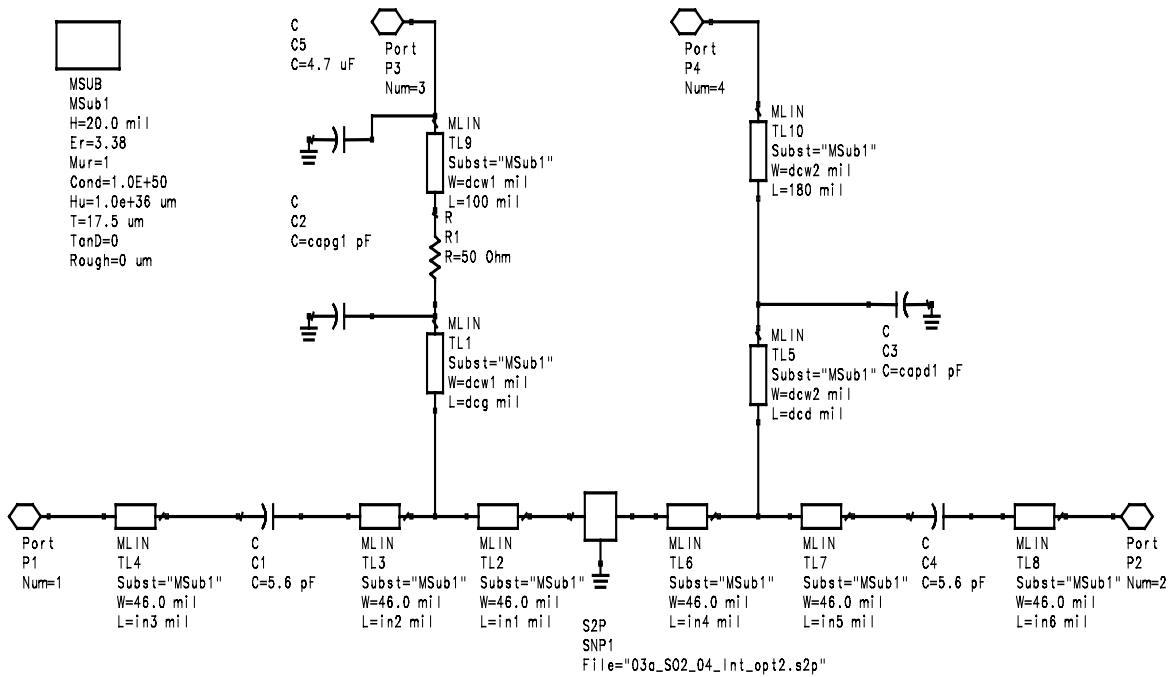

```

VAR
VAR1
in1=35 noopt { 20 to 200 }
in2=135 noopt { 20 to 300 }
in3=1010 noopt { 100 to 1000 }
in4=90 noopt { 20 to 500 }
in5=402 noopt { 20 to 500 }
in6=722 noopt { 100 to 1500 }
dcw1=38 opt { 25 to 70 }
dcw2=46 opt { 25 to 70 }
dcg=1000 opt { 100 to 1500 }
dcd=1100 opt { 100 to 1000 }
capg1=8.2 opt { 1.2 to 10 }
capd1=8.2 opt { 1.2 to 10 }
    
```

PCB is 20 mil thick Rogers 4003 substrate

Typical Evaluation Board Layout *

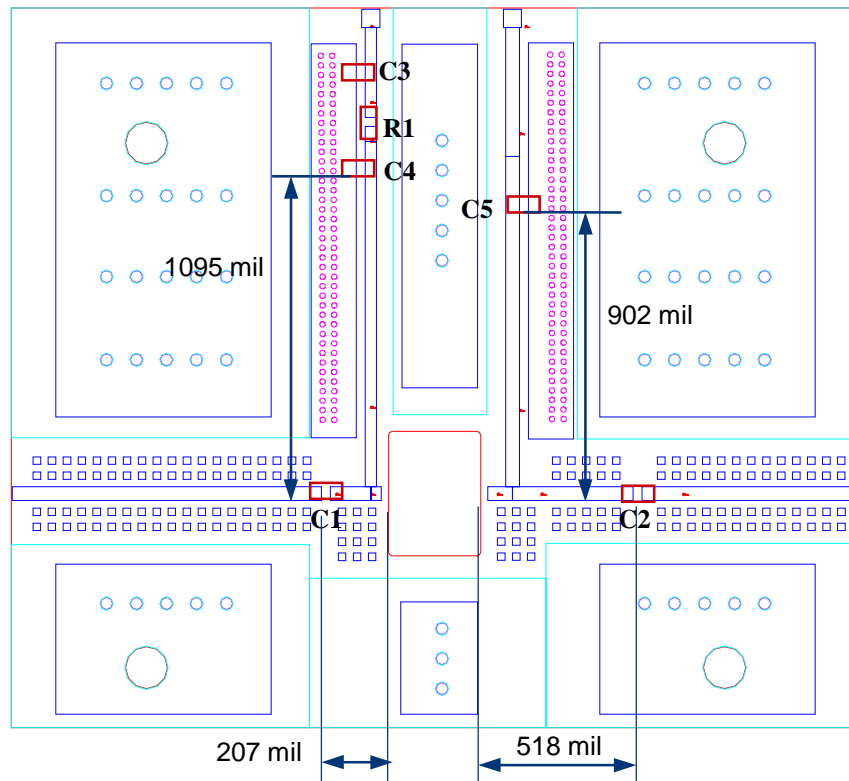

*The layout is a general purpose drawing that needs to be tuned for the specific application. PCB is RO4003 20 mil thickness, 0.5 oz standard copper cladding, with $\epsilon_r = 3.38$.

External Component Listing

Part Type	Reference	Description
Capacitor	C1	AVX 06035J5R6BBT, 5.6 pF
Capacitor	C2	AVX 06035J5R6BBT, 5.6 pF
Capacitor	C3	4.7uF
Capacitor	C4	AVX 06035J8R2BBT, 8.2 pF
Capacitor	C5	AVX 06035J8R2BBT, 8.2 pF
Resistor	R1	0805, 10 Ω

Contact TriQuint Applications Engineering for additional info

Recommended Surface Mount Package Assembly

Proper ESD precautions must be followed while handling packages.

Clean the board with acetone. Rinse with alcohol. Allow the circuit to fully dry.

TriQuint recommends using a conductive solder paste for attachment. Follow solder paste and reflow oven vendors' recommendations when developing a solder reflow profile. Typical solder reflow profiles are listed in the table below.

Hand soldering is not recommended. Solder paste can be applied using a stencil printer or dot placement. The volume of solder paste depends on PCB and component layout and should be well controlled to ensure consistent mechanical and electrical performance.

Clean the assembly with alcohol.

Typical Solder Reflow Profiles

Reflow Profile	SnPb	Pb Free
Ramp-up Rate	3 °C/sec	3 °C/sec
Activation Time and Temperature	60 – 120 sec @ 140 – 160 °C	60 – 180 sec @ 150 – 200 °C
Time above Melting Point	60 – 150 sec	60 – 150 sec
Max Peak Temperature	240 °C	260 °C
Time within 5 °C of Peak Temperature	10 – 20 sec	10 – 20 sec
Ramp-down Rate	4 – 6 °C/sec	4 – 6 °C/sec

Ordering Information

Part	Package Style
TGA2924-EPU-SD	Down Set (Straight Leads)