

DATA SHEET

POSITIVE TEMPERATURE COEFFICIENT AC/DC POWER SUPPLY

BK30 series

RoHS compliant & Halogen free



Product specification— December 01, 2022 V.2



Positive Temperature Coefficient (PTC) Data Sheet

Description

The 30V series provides radial resettable overcurrent protection with holding current from 0.9A to 9.0A. This series is suitable for applications with higher working voltage up to 30V.

Features

- Radial leaded devices.
- Over-current protection
- High voltage surge capabilities
- Flame retardant epoxy polymer insulating material meets UL94 V-0 requirement.
- Available in lead-free version.
- Meets MSL level 1, per J-STD-020
- Operating Temperature: -40°C ~+85°C



Applications

- Powered USB for POS and IPC
- USB hubs, ports and peripherals
- General electronics
- Computers & peripherals
- Automotive applications
- Motor protection

Part Number Code and Making

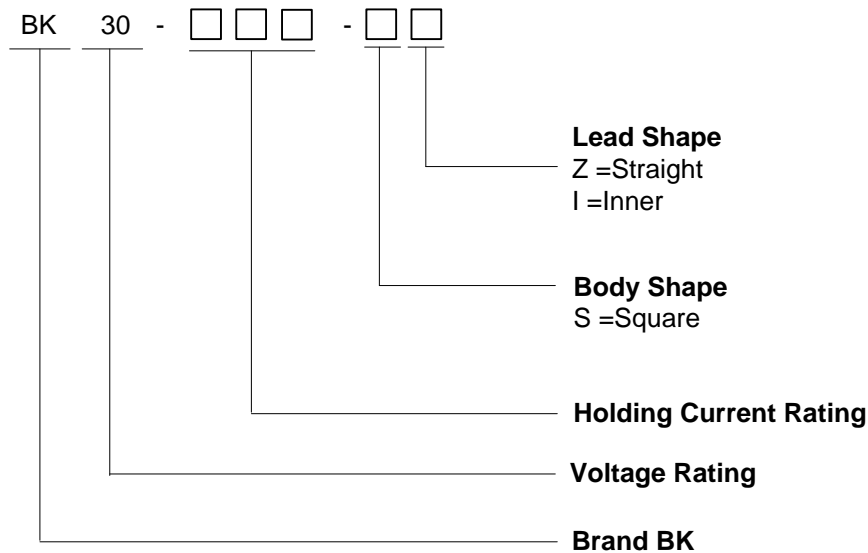

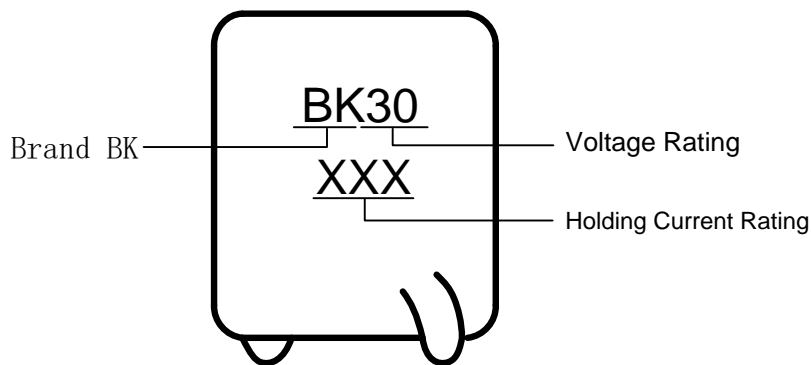

Dimensions (Unit: mm)

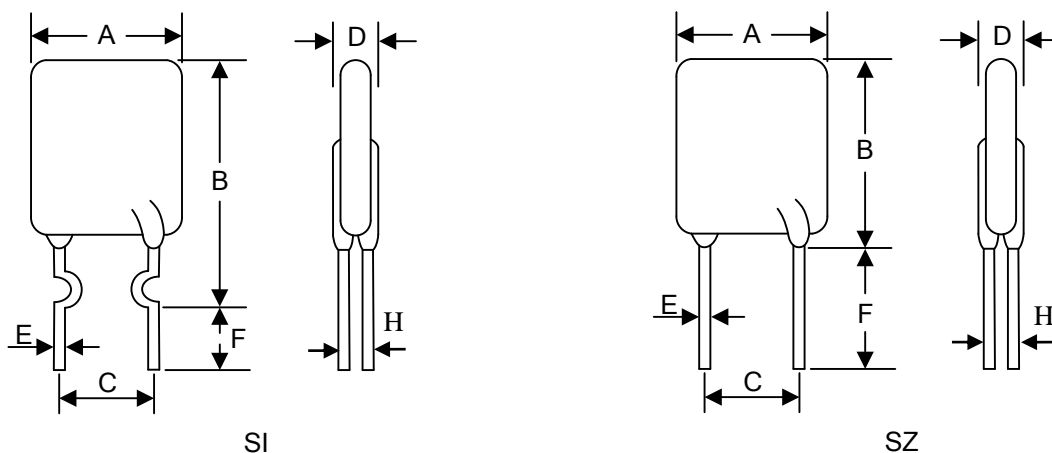

| Part Number | A | B | C | D | E | F | H | Style. |
|-------------|------|-----------|------|------|------|-----------|------|---------|
| | Max. | Max. | ±0.6 | Max. | Typ. | Min. | ±0.5 | |
| BK30-090 | 7.4 | 14.5/14.2 | 5.1 | 3.1 | 0.5 | 4.6 / 7.6 | 1.0 | SI / SZ |
| BK30-110 | 7.4 | 17.8/14.2 | 5.1 | 3.1 | 0.5 | 4.6 / 7.6 | 1.0 | SI / SZ |
| BK30-135 | 9.2 | 16.8 | 5.1 | 3.1 | 0.5 | 4.6 | 1.0 | SI |
| BK30-160 | 9.5 | 16.5 | 5.1 | 3.1 | 0.5 | 4.6 | 1.0 | SI |
| BK30-185 | 9.8 | 18.6 | 5.1 | 3.1 | 0.5 | 4.6 | 1.0 | SI |
| BK30-200 | 11.0 | 18.6 | 5.1 | 3.1 | 0.5 | 4.6 | 1.0 | SI |
| BK30-250 | 13.2 | 20.5 | 5.1 | 3.1 | 0.5 | 4.6 | 1.0 | SI |
| BK30-300 | 13.2 | 20.5 | 5.1 | 3.1 | 0.8 | 7.6 | 1.3 | SZ |
| BK30-400 | 14.0 | 23.6 | 5.1 | 3.1 | 0.8 | 7.6 | 1.3 | SZ |
| BK30-500 | 14.0 | 23.6 | 10.5 | 3.1 | 0.8 | 7.6 | 1.3 | SZ |
| BK30-600 | 17.5 | 27.5 | 10.5 | 3.1 | 0.8 | 7.6 | 1.3 | SZ |
| BK30-700 | 17.5 | 27.5 | 10.5 | 3.1 | 0.8 | 7.6 | 1.3 | SZ |
| BK30-800 | 23.5 | 31.0 | 10.5 | 3.1 | 0.8 | 7.6 | 1.3 | SZ |
| BK30-900 | 24.3 | 31.5 | 10.5 | 3.1 | 0.8 | 7.6 | 1.3 | SZ |

Electrical Characteristics

| Part Number | I _H | I _T | V _{max} | I _{max} | P _{d typ.} | Max. Time-to-trip | | R _{min} | R _{max} |
|-------------|----------------|----------------|--------------------|------------------|---------------------|-------------------|-------|------------------|------------------|
| | (A) | (A) | (V _{DC}) | (A) | (W) | (A) | (S) | (Ω) | (Ω) |
| BK30-090 | 0.90 | 1.80 | 30 | 40 | 0.6 | 4.50 | 5.90 | 0.090 | 0.220 |
| BK30-110 | 1.10 | 2.20 | 30 | 40 | 0.7 | 5.50 | 6.60 | 0.070 | 0.200 |
| BK30-135 | 1.35 | 2.70 | 30 | 40 | 0.8 | 6.75 | 7.30 | 0.055 | 0.160 |
| BK30-160 | 1.60 | 3.20 | 30 | 40 | 0.9 | 8.00 | 8.00 | 0.045 | 0.140 |
| BK30-185 | 1.85 | 3.70 | 30 | 40 | 1.0 | 9.25 | 8.70 | 0.035 | 0.120 |
| BK30-200 | 2.0 | 4.0 | 30 | 40 | 1.2 | 10.0 | 9.80 | 0.040 | 0.100 |
| BK30-250 | 2.5 | 5.0 | 30 | 40 | 1.2 | 12.5 | 10.30 | 0.027 | 0.080 |
| BK30-300 | 3.0 | 6.0 | 30 | 40 | 2.0 | 15.0 | 10.80 | 0.022 | 0.070 |
| BK30-400 | 4.0 | 8.0 | 30 | 40 | 2.5 | 20.0 | 12.70 | 0.010 | 0.060 |
| BK30-500 | 5.0 | 10.0 | 30 | 40 | 3.0 | 24.0 | 14.50 | 0.010 | 0.050 |
| BK30-600 | 6.0 | 12.0 | 30 | 40 | 3.5 | 30.0 | 16.00 | 0.005 | 0.040 |
| BK30-700 | 7.0 | 14.0 | 30 | 40 | 3.8 | 35.0 | 17.50 | 0.005 | 0.030 |
| BK30-800 | 8.0 | 16.0 | 30 | 40 | 4.0 | 40.0 | 18.80 | 0.005 | 0.025 |
| BK30-900 | 9.0 | 18.0 | 30 | 40 | 4.2 | 45.0 | 20.00 | 0.005 | 0.020 |

- I_H = Hold current: maximum current device will pass without tripping in 25°C still air.
- I_T = Trip current: minimum current at which the device will trip in 25°C still air.
- V_{MAX} = Maximum voltage device can withstand without damage at rated current.
- I_{MAX} = Maximum fault current device can withstand without damage at rated voltage.
- R_{MAX} = Maximum resistance of device in initial (un-soldered) state.
- R_{MIN} = Minimum resistance of device in initial (un-soldered) state.
- P_{d typ.} = Typical power dissipation from device when in the tripped state at 25°C still air.

Polymeric PTC Selecting Guide

■ Determine the following operating parameters for the circuits:

- Normal operating current (I_{hold})
- Maximum interrupt current (I_{max})
- Maximum circuit voltage (V_{max})
- Normal operating temperature surrounding device (min °C/max °C)

■ Select the device from factor and dimension suitable for the application

■ Compare the maximum rating for V_{max} and I_{max} of the PPTC device with the circuit in application and make sure the circuit's requirement does not exceed the device rating.

■ Check that PPTC device's trip time (time-to-trip) will protect the circuit.

■ Verify that the circuit operating temperature is within the PPTC device's normal operating temperature range.

■ Verify that performance and suitability of the chosen PPTC device in the application.

WARNING

■ Mechanical Stress

- PPTC devices will undergo a thermal expansion during fault condition. If PPTC devices are installed or placed in an application where the space between PPTC devices and the surrounding materials (e.g., covering materials, packaging materials, encapsulate materials and the like) is insufficient, it will cause an inhibiting effect upon the thermal expansion. Pressing, twisting, bending and other kinds of mechanical stress will also adversely affect the performance of the PPTC devices, and shall not be used or applied.

■ Chemical Pollutants

- Silicone-based oils, oils, solvents, gels, electrolytes, fuels, acids, and the like will adversely affect the properties of PPTC devices, and shall not be used or applied.

■ Electronic and Thermal Effect

- PPTC devices are secondary protection devices and are used solely for sporadic, accidental over-current or over-temperature error condition, and shall NOT be used if or when constant or repeated fault conditions (such fault conditions may be caused by, among others, incorrect pin-connection of a connector) or over-extensive trip events may occur.
- PPTC devices are different from fuses and, when a fault condition occurs, will go into high-resistance state and do not open circuit, in which case the voltage at such PPTC devices may reach a hazardous level.
- Operation over the maximum rating or other forms of improper use may cause failure, arcing, flame and/or other damage to the PPTC devices.
- Conductive material contamination, such as metal particle, may induce shortage, flame or arcing.
- Due to the inductance, the operation circuits may generate a circuit voltage (Ldi/dt) above the rated voltage of PPTC devices, which shall not be used under such circumstances.

■ General

- Customers shall evaluate and test the properties of PPTC devices independently to verify and ensure that their individual applications will be met.
- The performance of PPTC devices will be adversely affected if they are improperly used under electronic, thermal and/or mechanical procedures and/or conditions non-conformant to those recommended by manufacturer.
- Customers shall be responsible for determining whether it is necessary to have back-up, failsafe and/or fool-proof protection To avoid or minimize damage that may result from extra-ordinary, irregular function or failure of PPTC devices.
- Any and all responsibilities and liabilities are disclaimed if any item under this notice of warning is not complied with.

Thermal Derating Curve

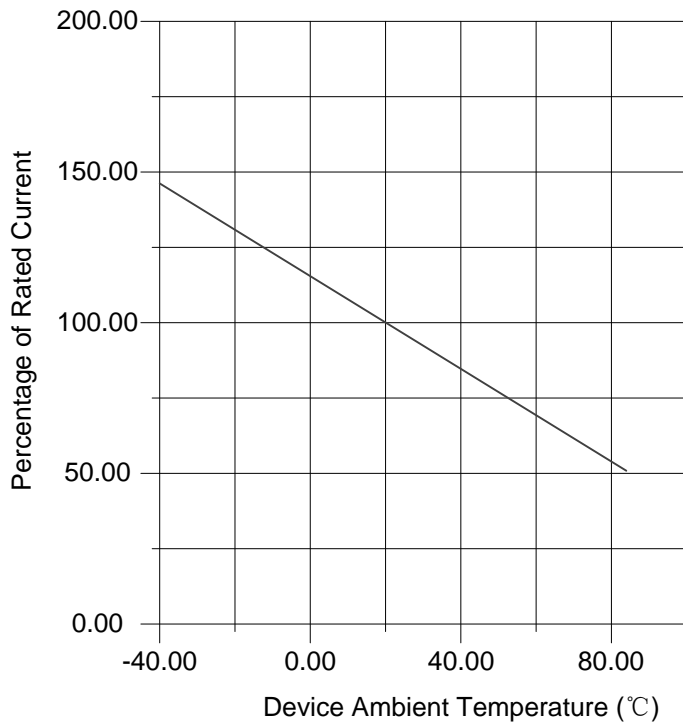

Thermal Derating Chart – I_H (A)

| Part Number | Maximum Ambient Operating Temperatures (°C) | | | | | | | | | |
|-------------|---|-------|-------|------|------|------|------|------|------|------|
| | -40 | -20 | 0 | 25 | 30 | 40 | 50 | 60 | 70 | 85 |
| BK30-090 | 1.25 | 1.17 | 1.04 | 0.90 | 0.82 | 0.75 | 0.69 | 0.61 | 0.55 | 0.47 |
| BK30-110 | 1.50 | 1.43 | 1.27 | 1.10 | 1.00 | 0.91 | 0.85 | 0.75 | 0.67 | 0.57 |
| BK30-135 | 1.90 | 1.76 | 1.55 | 1.35 | 1.23 | 1.12 | 1.04 | 0.92 | 0.82 | 0.70 |
| BK30-160 | 2.20 | 2.08 | 1.84 | 1.60 | 1.46 | 1.33 | 1.23 | 1.09 | 0.98 | 0.83 |
| BK30-185 | 2.62 | 2.41 | 2.13 | 1.85 | 1.68 | 1.54 | 1.42 | 1.26 | 1.13 | 0.96 |
| BK30-200 | 2.80 | 2.60 | 2.30 | 2.00 | 1.82 | 1.66 | 1.54 | 1.36 | 1.22 | 1.04 |
| BK30-250 | 3.50 | 3.25 | 2.88 | 2.50 | 2.28 | 2.08 | 1.93 | 1.70 | 1.53 | 1.30 |
| BK30-300 | 4.20 | 3.90 | 3.45 | 3.00 | 2.73 | 2.49 | 2.31 | 2.04 | 1.83 | 1.56 |
| BK30-400 | 5.60 | 5.20 | 4.60 | 4.00 | 3.64 | 3.32 | 3.08 | 2.72 | 2.44 | 2.08 |
| BK30-500 | 7.10 | 6.50 | 5.75 | 5.00 | 4.55 | 4.15 | 3.85 | 3.40 | 3.05 | 2.60 |
| BK30-600 | 8.50 | 7.80 | 6.90 | 6.00 | 5.46 | 4.98 | 4.62 | 4.08 | 3.66 | 3.12 |
| BK30-700 | 9.90 | 9.10 | 8.05 | 7.00 | 6.37 | 5.81 | 5.39 | 4.76 | 4.27 | 3.64 |
| BK30-800 | 11.30 | 10.40 | 9.20 | 8.00 | 7.28 | 6.64 | 6.16 | 5.44 | 4.88 | 4.16 |
| BK30-900 | 12.70 | 11.70 | 10.35 | 9.00 | 8.19 | 7.47 | 6.93 | 6.12 | 5.49 | 4.68 |

Test Procedures and Requirement

| Items | Test Conditions | Accept/Reject Criteria |
|-----------------|-------------------------------------|---|
| Resistance | In still air @25°C | $R_{min} \leq R \leq R_{max}$ |
| Time to Trip | Specified current, V_{max} , 25°C | $T \leq \text{max. Time to trip } (T_{trip})$ |
| Hold Current | 30 min, at I_H | No trip |
| Trip Cycle Life | V_{max} , I_{max} , 100 cycles | No arcing or burning |
| Trip Endurance | V_{max} , 24hours | No arcing or burning |

Typical Time-to-Trip Charts @25°C

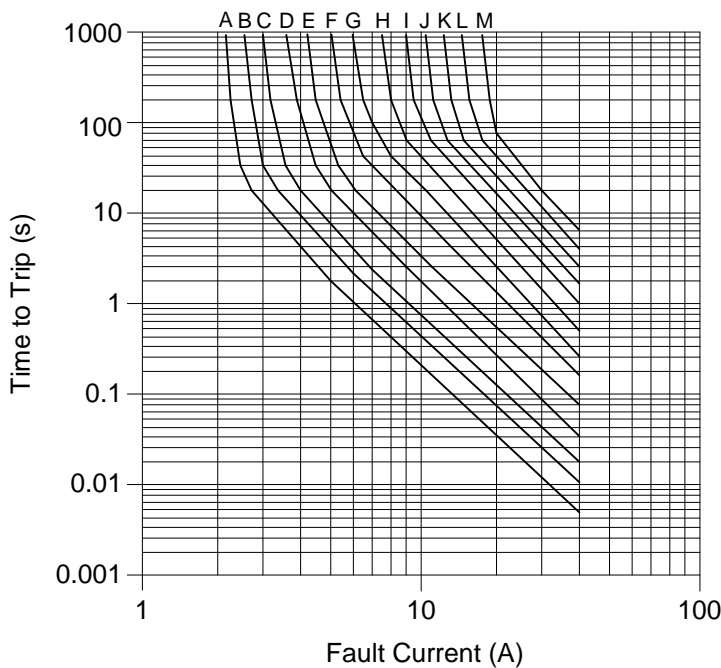

- A=BK30-090
- B=BK30-110
- C=BK30-135
- D=BK30-160
- E=BK30-185
- F=BK30-250
- G=BK30-300
- H=BK30-400
- I=BK30-500
- J=BK30-600
- K=BK30-700
- L=BK30-800
- M=BK30-900

Storage Recommendations

- Storage Temperature: -10°C~+40°C
- Relative Humidity: ≤80%RH
- Keep away from corrosive atmosphere and sunlight.
- Period of Storage: 1 year.

Wave Soldering Recommendation Parameters

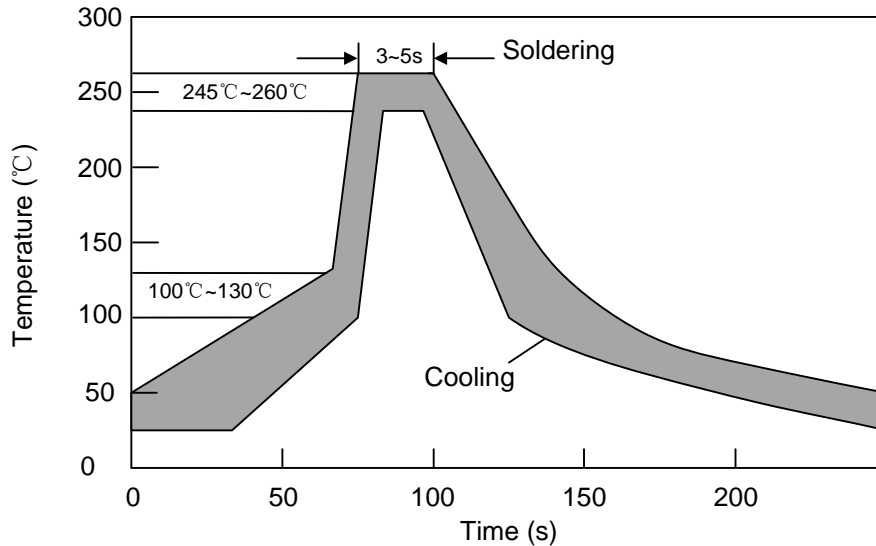

| Items | Conditions |
|------------------|---|
| Pre-Heating Zone | Refer to the condition recommended by the flux manufacturer. Maximum ramping rate should not exceed 4°C/sec. |
| Soldering Zone | Maximum solder temperature should not exceed 260°C |
| Cooling Zone | Forced cooling |

Manual Soldering Recommendation Parameters

| Items | Conditions |
|---------------------|--|
| Soldering condition | The highest power of the manual soldering iron should be 30W or less, soldering temperature should not be higher than 280°C. |
| Soldering time | The soldering time should be kept within 3 seconds, otherwise it might cause insulation layer cracking, and increased part resistance. |
| Soldering position | The distance on the leads between the soldering point and bottom of the PPTC body should be equal or greater than 4mm. |
| Other | The soldering iron should not contact the PPTC body except the leads. If the soldering conditions are kept to lower temperature, less time and larger distance, the outcome of the soldering will be better. |

Mechanical Characteristics

| Items | Specifications | Test Conditions/Methods |
|------------------|-------------------|----------------------------------|
| Tensile strength | No visible damage | 1.0Kgf, 10 seconds |
| Bending strength | No visible damage | 0.5Kgf, 90° , 3 times |
| Vibration | No visible damage | Freq: 10-55Hz, Amp: 0.75mm, 1min |

Reliability Test

| Items | Specifications | Test Conditions/Methods |
|------------------------------|---|---|
| Solder ability | No visible damage, Solder OK, Solder area $\geq 95\%$ | 245 \pm 5 $^{\circ}$ C, 2 \pm 1s, dipping depth=0.5inch max from the body |
| Resistance to soldering heat | No visible damage, Electrical OK, $ \Delta R/R0 \leq 50\%$ | 260 \pm 5 $^{\circ}$ C, 10+2/-0s |
| Damp heat, steady state | No visible damage, Electrical OK, $ \Delta R/R0 \leq 20\%$ | 40 \pm 2 $^{\circ}$ C, 90~95 % RH, total 48Hrs, after 4Hrs test electrical parameter |
| Temperature cycling | No visible damage, Electrical OK, $ \Delta R/R0 \leq 20\%$ | Ta=-10+0/-1 $^{\circ}$ C 30min, Ta=70+1/-0 $^{\circ}$ C 30min, 5cycles, after 1hr test electrical parameter |

Packaging

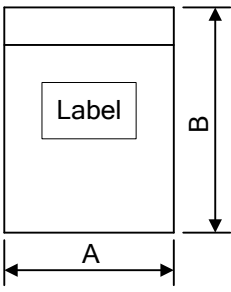
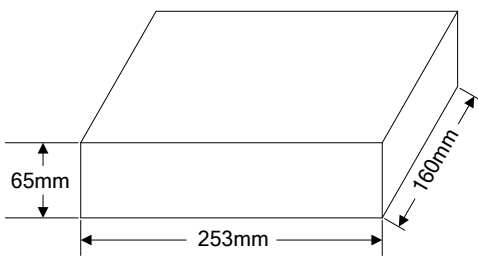
| Bag | Part Number | Dimension AxB (mm) | Quantity |
|---|-------------|--------------------|----------------------------|
|  | BK30-090 | 120x150 | 1000pcs/bag 4000pcs/box |
| | BK30-110 | | |
| | BK30-135 | | |
| | BK30-160 | 150x200 | |
| | BK30-185 | | |
| | BK30-200 | | |
|  | BK30-250 | 150x200 | 500pcs/bag 2000pcs/box |
| | BK30-300 | 120x150 | |
| | BK30-400 | 150x200 | |
| | BK30-500 | | |
| | BK30-600 | 150x200 | 200pcs/bag 800pcs/box |
| | BK30-700 | | |
| | BK30-800 | | |
| | BK30-900 | | |