

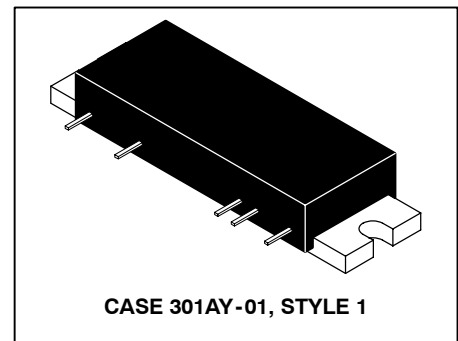
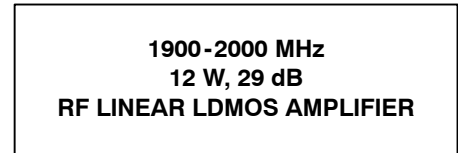
# PCS Band RF Linear LDMOS Amplifier

Designed for ultra-linear amplifier applications in 50 ohm systems operating in the PCS frequency band. A silicon FET Class A design provides outstanding linearity and gain. In addition, the excellent group delay and phase linearity characteristics are ideal for digital modulation systems, such as TDMA and CDMA.

- Third Order Intercept: 49.5 dBm Typ
- Power Gain: 29 dB Typ (@ f = 1960 MHz)
- Input VSWR ≤ 1.5:1

**Features**

- Excellent Phase Linearity and Group Delay Characteristics
- Ideal for Feedforward Base Station Applications
- Replaced MHL19936. There are no form, fit or function changes with this part replacement.
- N Suffix Indicates Lead-Free Terminations



ARCHIVE INFORMATION

ARCHIVE INFORMATION

**Table 1. Absolute Maximum Ratings** (T<sub>C</sub> = 25°C unless otherwise noted)

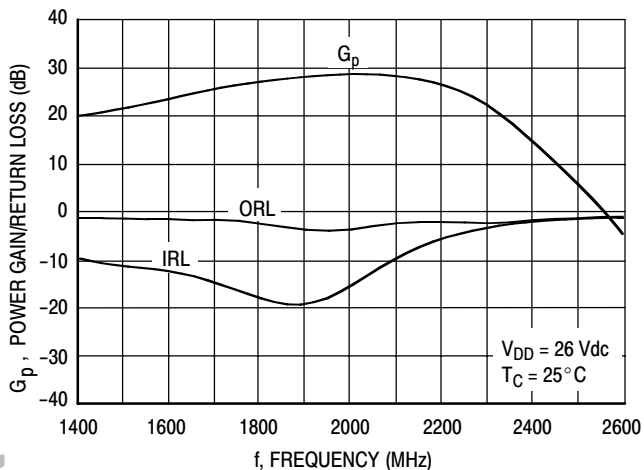
Rating	Symbol	Value	Unit
DC Supply Voltage	V <sub>DD</sub>	30	Vdc
RF Input Power	P <sub>in</sub>	+16	dBm
Storage Temperature Range	T <sub>stg</sub>	- 40 to +100	°C
Operating Case Temperature Range	T <sub>C</sub>	- 20 to +100	°C

**Table 2. Electrical Characteristics** (V<sub>DD</sub> = 26 Vdc, T<sub>C</sub> = 25°C; 50 Ω System)

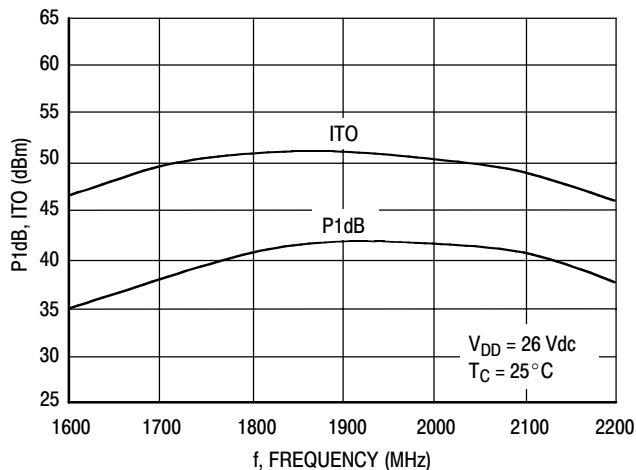
Characteristic	Symbol	Min	Typ	Max	Unit
Supply Current	I <sub>DD</sub>	—	1.4	1.45	A
Power Gain (f = 1960 MHz)	G <sub>p</sub>	27.5	29	30.5	dB
Gain Flatness (f = 1900 - 2000 MHz)	G <sub>F</sub>	—	0.2	0.4	dB
Power Output @ 1 dB Compression (f = 1950 MHz)	P <sub>1dB</sub>	40	41	—	dBm
Third Order Intercept (f <sub>1</sub> = 1950 MHz, f <sub>2</sub> = 1955 MHz)	I <sub>TO</sub>	49	49.5	—	dBm
Noise Figure (f = 2000 MHz)	NF	—	4.2	4.5	dB

**NOTE - CAUTION** - MOS devices are susceptible to damage from electrostatic charge. Reasonable precautions in handling and packaging MOS devices should be observed.

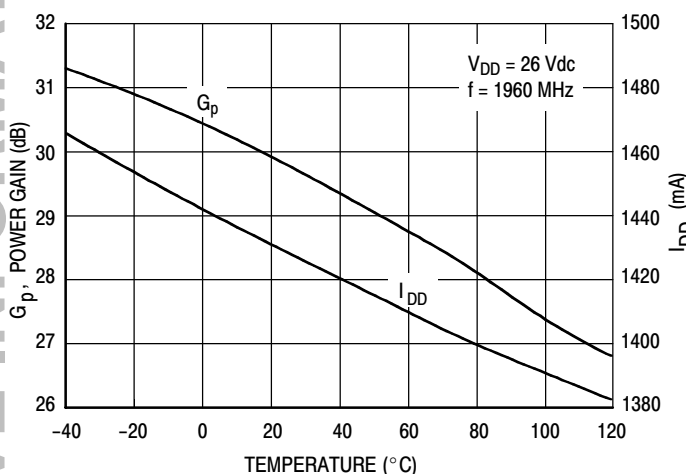
## TYPICAL CHARACTERISTICS



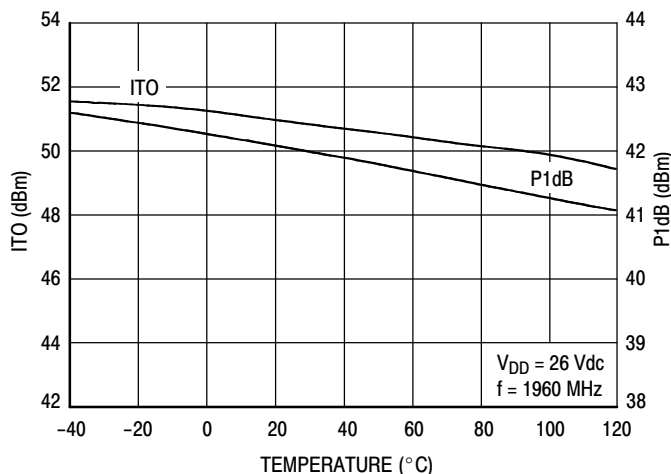
**Figure 1. Power Gain, Input Return Loss, Output Return Loss versus Frequency**



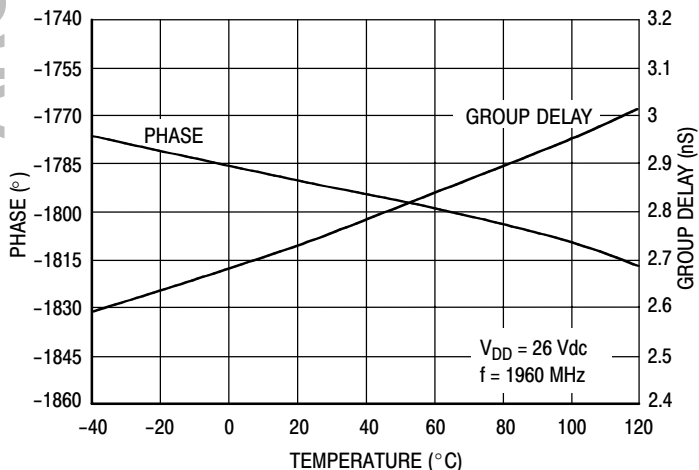
**Figure 2. P1dB, ITO versus Frequency**



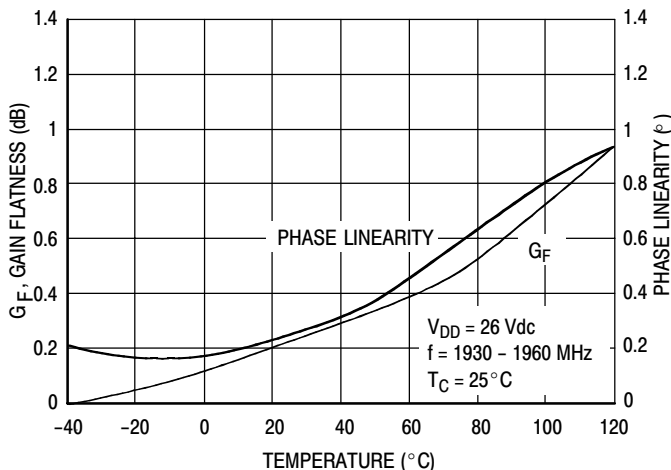
**Figure 3. Power Gain,  $I_{DD}$  versus Temperature**



**Figure 4. ITO, P1dB versus Temperature**



**Figure 5. Phase<sup>(1)</sup>, Group Delay<sup>(1)</sup> versus Temperature**



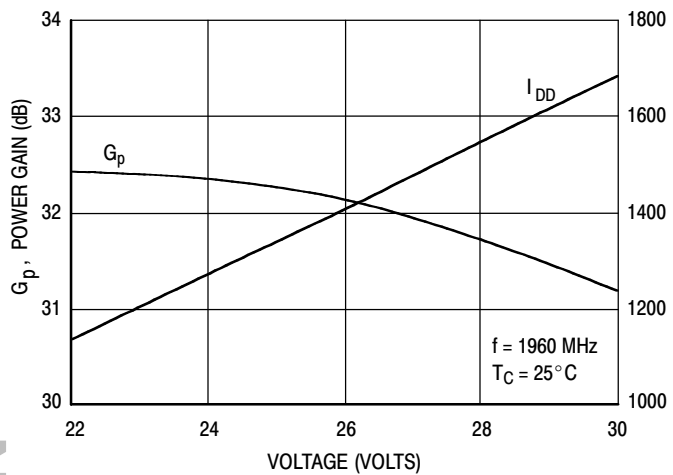
**Figure 6. Gain Flatness, Phase Linearity versus Temperature**

1. In Production Test Fixture

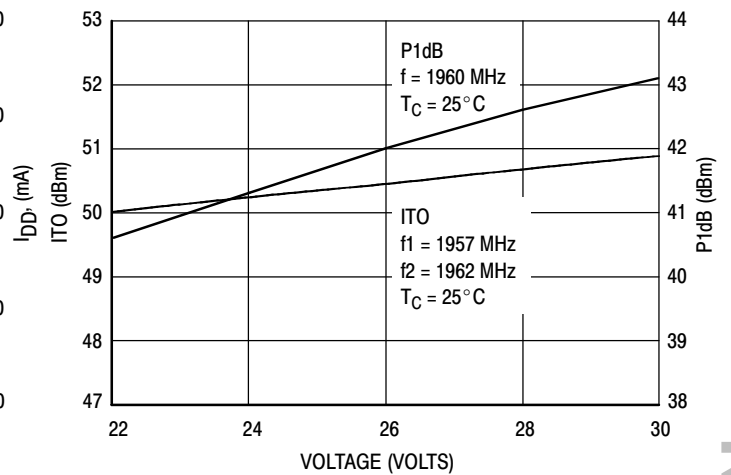
ARCHIVE INFORMATION

ARCHIVE INFORMATION

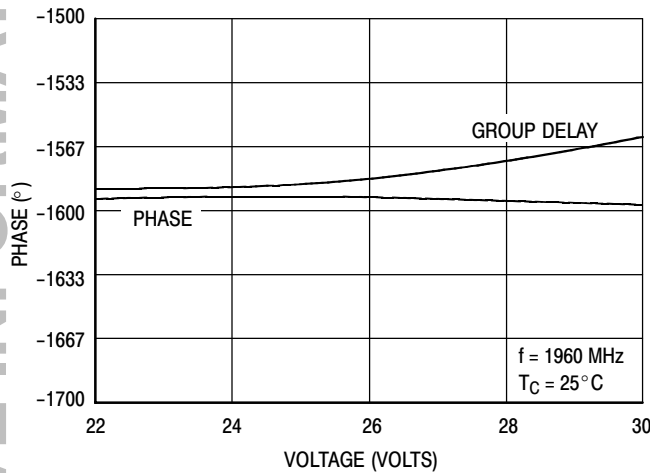
## TYPICAL CHARACTERISTICS



**Figure 7. Power Gain,  $I_{DD}$  versus Voltage**

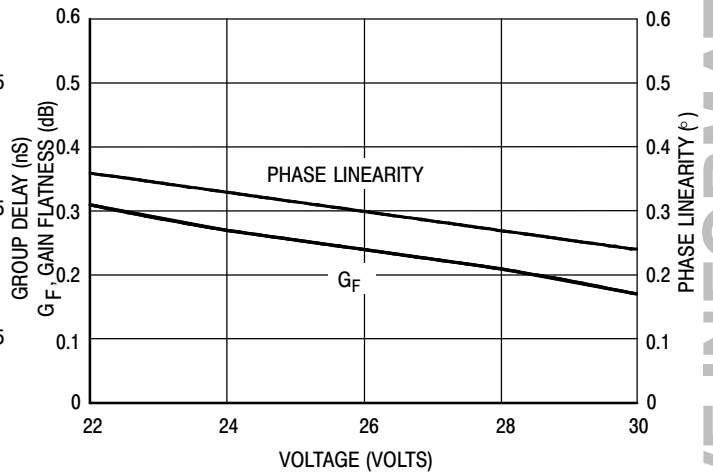


**Figure 8. ITO, P1dB versus Voltage**



**Figure 9. Phase<sup>(1)</sup>, Group Delay<sup>(1)</sup> versus Voltage**

1. In Production Test Fixture

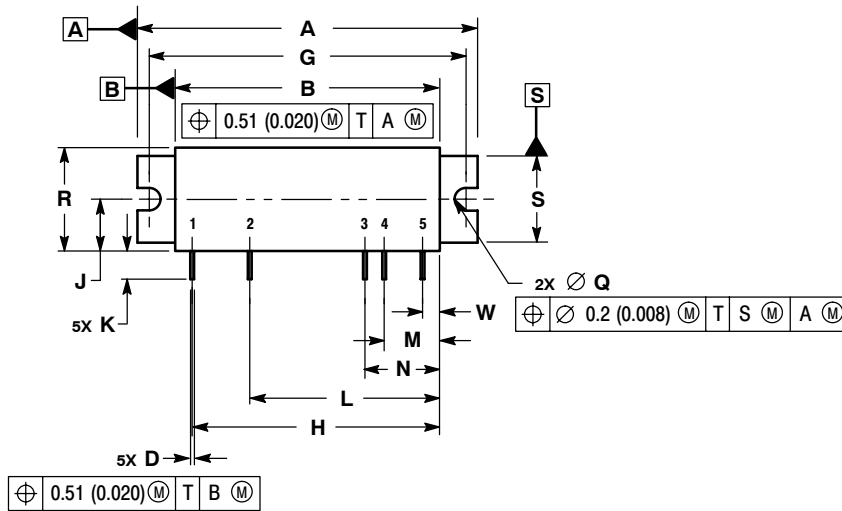


**Figure 10. Phase Linearity, Gain Flatness versus Voltage**

ARCHIVE INFORMATION

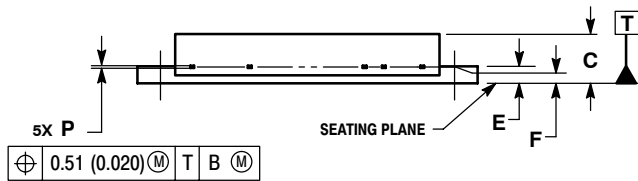
ARCHIVE INFORMATION

### PACKAGE DIMENSIONS



- NOTES:
1. CONTROLLING DIMENSION: MILLIMETER.
  2. INTERPRET DIMENSIONS AND TOLERANCES PER ANSI Y14.5M, 1982.
  3. DIMENSION F TO CENTER LINE OF LEADS.

DIM	MILLIMETERS		INCHES	
	MIN	MAX	MIN	MAX
A	44.7	45.21	1.760	1.780
B	34.8	35.31	1.370	1.390
C	6.22	6.73	0.245	0.265
D	0.43	0.58	0.017	0.023
E	2.03	2.54	0.080	0.100
F	2.18 BSC		0.086 BSC	
G	41.91 BSC		1.650 BSC	
H	32.77 BSC		1.290 BSC	
J	6.76	7.11	0.266	0.280
K	3.18	4.19	0.125	0.165
L	25.15 BSC		0.990 BSC	
M	7.37 BSC		0.290 BSC	
N	9.91 BSC		0.390 BSC	
P	0.2	0.33	0.008	0.013
Q	3	3.35	0.118	0.132
R	13.59	14.1	0.535	0.555
S	11.3	11.81	0.445	0.465
W	2.29 BSC		0.090 BSC	



- STYLE 1:
- PIN 1: RF INPUT
  - VDD1
  - VDD2
  - VDD3
  - RF OUTPUT
- CASE: GROUND

CASE 301AY-01  
ISSUE A

**How to Reach Us:**

**Home Page:**  
www.freescale.com

**E-mail:**  
support@freescale.com

**USA/Europe or Locations Not Listed:**  
Freescale Semiconductor  
Technical Information Center, CH370  
1300 N. Alma School Road  
Chandler, Arizona 85224  
+1-800-521-6274 or +1-480-768-2130  
support@freescale.com

**Europe, Middle East, and Africa:**  
Freescale Halbleiter Deutschland GmbH  
Technical Information Center  
Schatzbogen 7  
81829 Muenchen, Germany  
+44 1296 380 456 (English)  
+46 8 52200080 (English)  
+49 89 92103 559 (German)  
+33 1 69 35 48 48 (French)  
support@freescale.com

**Japan:**  
Freescale Semiconductor Japan Ltd.  
Headquarters  
ARCO Tower 15F  
1-8-1, Shimo-Meguro, Meguro-ku,  
Tokyo 153-0064  
Japan  
0120 191014 or +81 3 5437 9125  
support.japan@freescale.com

**Asia/Pacific:**  
Freescale Semiconductor Hong Kong Ltd.  
Technical Information Center  
2 Dai King Street  
Tai Po Industrial Estate  
Tai Po, N.T., Hong Kong  
+800 2666 8080  
support.asia@freescale.com

**For Literature Requests Only:**  
Freescale Semiconductor Literature Distribution Center  
P.O. Box 5405  
Denver, Colorado 80217  
1-800-441-2447 or 303-675-2140  
Fax: 303-675-2150  
LDCForFreescaleSemiconductor@hibbertgroup.com

Information in this document is provided solely to enable system and software implementers to use Freescale Semiconductor products. There are no express or implied copyright licenses granted hereunder to design or fabricate any integrated circuits or integrated circuits based on the information in this document.

Freescale Semiconductor reserves the right to make changes without further notice to any products herein. Freescale Semiconductor makes no warranty, representation or guarantee regarding the suitability of its products for any particular purpose, nor does Freescale Semiconductor assume any liability arising out of the application or use of any product or circuit, and specifically disclaims any and all liability, including without limitation consequential or incidental damages. "Typical" parameters that may be provided in Freescale Semiconductor data sheets and/or specifications can and do vary in different applications and actual performance may vary over time. All operating parameters, including "Typicals", must be validated for each customer application by customer's technical experts. Freescale Semiconductor does not convey any license under its patent rights nor the rights of others. Freescale Semiconductor products are not designed, intended, or authorized for use as components in systems intended for surgical implant into the body, or other applications intended to support or sustain life, or for any other application in which the failure of the Freescale Semiconductor product could create a situation where personal injury or death may occur. Should Buyer purchase or use Freescale Semiconductor products for any such unintended or unauthorized application, Buyer shall indemnify and hold Freescale Semiconductor and its officers, employees, subsidiaries, affiliates, and distributors harmless against all claims, costs, damages, and expenses, and reasonable attorney fees arising out of, directly or indirectly, any claim of personal injury or death associated with such unintended or unauthorized use, even if such claim alleges that Freescale Semiconductor was negligent regarding the design or manufacture of the part.

Freescale™ and the Freescale logo are trademarks of Freescale Semiconductor, Inc. All other product or service names are the property of their respective owners.  
© Freescale Semiconductor, Inc. 2006. All rights reserved.

