

T-58-11-13

ECG[®] Semiconductors

**ECG959, ECG961, ECG963,
ECG965, ECG967, ECG969,
ECG971**

**Three-Terminal Negative
Fixed Voltage Regulators**

Features

- No external components required
- Internal thermal overload protection
- Internal short-circuit current limiting
- Output transistor safe-area compensation

This series of fixed output negative voltage regulators are intended as complements to the popular positive voltage series devices. These negative regulators are available in seven voltage options from -5.0 to -24 volts. These regulators employ current limiting, thermal shutdown, and safe-area compensation - making them remarkably rugged under most operating conditions. With adequate heat-sinking they can deliver output currents in excess of 1.0 ampere.

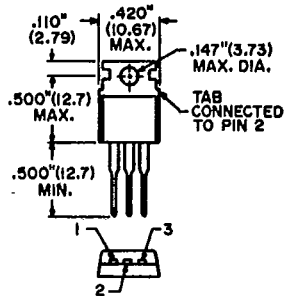

Pin 1 Ground
Pin 2 Input
Pin 3 Output

| Type No. | Negative Output Voltage |
|----------|-------------------------|
| ECG959 | - 18 Volts |
| ECG961 | - 5.0 Volts |
| ECG963 | - 6.0 Volts |
| ECG965 | - 8.0 Volts |
| ECG967 | - 12 Volts |
| ECG969 | - 15 Volts |
| ECG971 | - 24 Volts |

Schematic Diagram

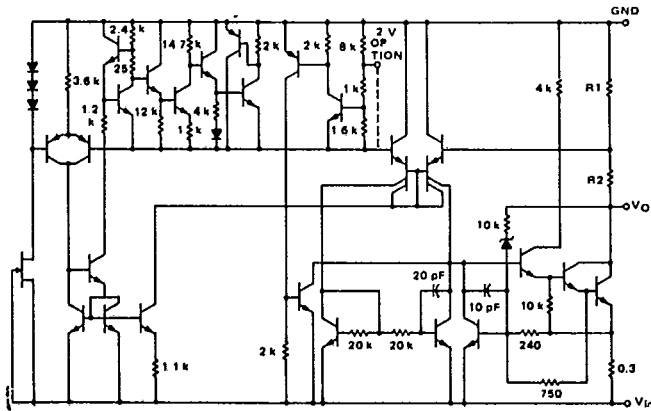

ECG959, ECG961, ECG963,
ECG965, ECG967, ECG969, ECG971

T-58-11-13

Maximum Ratings ($T_A = 25^\circ\text{C}$ unless otherwise noted)

| Rating | Symbol | Value | Unit |
|--|--|---|----------------------------------|
| Input Voltage 2.0 V - 18 V 24 V | V_I | -35 -40 | Vdc |
| Power Dissipation $T_A = +25^\circ\text{C}$ Derate Above $T_A = +25^\circ\text{C}$ $T_C = +25^\circ\text{C}$ Derate Above $T_C = +95^\circ\text{C}$ (See Fig. 1) | P_D $1/R_{\theta JA}$ P_D $1/R_{\theta JC}$ | Internally Limited 15.4 Internally Limited 200 | Watts mW/°C Watts mW/°C |
| Storage Temperature Range | T_{stg} | -65 to +150 | °C |
| Operating Junction Temperature Range | T_{opg} | 0 to +150 | °C |

Thermal Characteristics

| Characteristic | Symbol | Max | Unit |
|---|-----------------|-----|------|
| Thermal Resistance, Junction to Ambient | $R_{\theta JA}$ | 65 | °C/W |
| Thermal Resistance, Junction to Case | $R_{\theta JC}$ | 50 | °C/W |

Definitions

Line Regulation—The change in output voltage for a change in the input voltage. The measurement is made under conditions of low dissipation or by using pulse techniques such that the average chip temperature is not significantly affected.

Load Regulation—The change in output voltage for a change in load current at constant chip temperature.

Maximum Power Dissipation—The maximum total device dissipation for which the regulator will operate within specifications.

Quiescent Current—That part of the input current that is not delivered to the load.

Output Noise Voltage—The rms ac voltage at the output, with constant load and no input ripple, measured over a specified frequency range.

Long Term Stability—Output voltage stability under accelerated life test conditions with the maximum rated voltage listed in the devices' electrical characteristics and maximum power dissipation.

Electrical Characteristics

ECG959 ($V_I = -27\text{ V}$, $I_O = 500\text{ mA}$, $0^\circ\text{C} < T_{opg} < +125^\circ\text{C}$ unless otherwise noted.)

| Characteristic | Symbol | Min | Typ | Max | Unit |
|--|-------------------------|-------|------|-------|---------------|
| Output Voltage ($T_{opg} = +25^\circ\text{C}$) | V_O | -17.3 | -18 | -18.7 | Vdc |
| Line Regulation ($T_{opg} = +25^\circ\text{C}$, $I_O = 100\text{ mA}$) | Reg_{line} | .. | 25 | 180 | mV |
| -21 Vdc $\geq V_I \geq$ -33 Vdc | | .. | 10 | 90 | |
| -24 Vdc $\geq V_I \geq$ -30 Vdc | | .. | 90 | 360 | |
| ($T_{opg} = +25^\circ\text{C}$, $I_O = 500\text{ mA}$) | | .. | 50 | 180 | |
| -21 Vdc $\geq V_I \geq$ -33 Vdc | | .. | 110 | 360 | |
| -24 Vdc $\geq V_I \geq$ -30 Vdc | | .. | 65 | 180 | |
| Load Regulation $T_{opg} = +25^\circ\text{C}$, $5.0\text{ mA} < I_O < 1.0\text{ A}$ $250\text{ mA} < I_O < 750\text{ mA}$ | Reg_{load} | .. | .. | .. | mV |
| Output Voltage (-21 Vdc $\geq V_I \geq$ -33 Vdc, $5.0\text{ mA} < I_O < 1.0\text{ A}$, $P < 15\text{ W}$) | V_O | -17.1 | .. | -18.9 | Vdc |
| Quiescent Current ($T_{opg} = +25^\circ\text{C}$) | I_B | .. | 4.5 | 8.0 | mA |
| Quiescent Current Change -21 Vdc $\geq V_I <$ -33 Vdc $5.0\text{ mA} < I_O < 1.0\text{ A}$ | ΔI_B | .. | .. | 1.0 | mA |
| Output Noise Voltage ($T_A = +25^\circ\text{C}$, $10\text{ Hz} < f < 100\text{ kHz}$) | V_N | .. | 110 | .. | μV |
| Long-Term Stability | $\Delta V_O / \Delta t$ | .. | .. | 72 | mV/1.0 k HRS |
| Ripple Rejection ($I_O = 20\text{ mA}$, $f = 120\text{ Hz}$) | RR | .. | 69 | .. | dB |
| Input-Output Voltage Differential ($I_O = 1.0\text{ A}$, $T_{opg} = +25^\circ\text{C}$) | $ V_{in} - V_O $ | .. | 2.0 | .. | Vdc |
| Average Temperature Coefficient of Output Voltage $I_O = 5.0\text{ mA}$, $0^\circ\text{C} < T_A < +125^\circ\text{C}$ | TCV_O | .. | -1.0 | .. | mV/°C |

ECG959, ECG961, ECG963,
ECG965, ECG967, ECG969, ECG971

T-58-11-13

ECG961 ($V_{in} = -10\text{ V}$, $I_0 = 500\text{ mA}$, $0^\circ\text{C} < T_{\text{opp}} < +125^\circ\text{C}$ unless otherwise noted.)

| Characteristic | Symbol | Min | Typ | Max | Unit |
|---|----------------------------|-------|------------|------------|---------------|
| Output Voltage ($T_{\text{opp}} = +25^\circ\text{C}$) | V_O | -4.8 | -5.0 | -6.2 | Vdc |
| Line Regulation ($T_{\text{opp}} = +25^\circ\text{C}$, $I_0 = 100\text{ mA}$) -7.0 Vdc $\geq V_{in} \geq -25\text{ Vdc}$ -8.0 Vdc $\geq V_{in} \geq -12\text{ Vdc}$ ($T_{\text{opp}} = +25^\circ\text{C}$, $I_0 = 500\text{ mA}$) -7.0 Vdc $\geq V_{in} \geq -25\text{ Vdc}$ -8.0 Vdc $\geq V_{in} \geq -12\text{ Vdc}$ | Reg_{line} | -- | 7.0 2.0 | 50 25 | mV |
| Load Regulation $T_{\text{opp}} = +25^\circ\text{C}$, $5.0\text{ mA} < I_0 < 1.5\text{ A}$ $250\text{ mA} < I_0 < 750\text{ mA}$ | Reg_{load} | -- | 11 4.0 | 100 50 | mV |
| Output Voltage (-7.0 Vdc $\geq V_{in} \geq -20\text{ Vdc}$, $5.0\text{ mA} < I_0 < 1.0\text{ A}$, $P < 15\text{ W}$) | V_O | -4.75 | -- | -5.25 | Vdc |
| Quiescent Current ($T_{\text{opp}} = +25^\circ\text{C}$) | I_B | -- | 4.3 | 8.0 | mA |
| Quiescent Current Change -7.0 Vdc $\geq V_{in} \geq -25\text{ Vdc}$ $5.0\text{ mA} < I_0 < 1.5\text{ A}$ | ΔI_B | -- | -- | 1.3 0.5 | mA |
| Output Noise Voltage ($T_A = +25^\circ\text{C}$, $10\text{ Hz} < f < 100\text{ kHz}$) | V_N | -- | 40 | -- | μV |
| Long-Term Stability | $\Delta V_O / \Delta t$ | -- | -- | 20 | mV/1.0 k HRS |
| Ripple Rejection ($I_0 = 20\text{ mA}$, $f = 120\text{ Hz}$) | RR | -- | 70 | -- | dB |
| Input-Output Voltage Differential $I_0 = 1.0\text{ A}$, $T_{\text{opp}} = +25^\circ\text{C}$ | $ V_{in} - V_O $ | -- | 2.0 | -- | Vdc |
| Average Temperature Coefficient of Output Voltage $I_0 = 5\text{ mA}$, $0^\circ\text{C} < T_A < +125^\circ\text{C}$ | TCV_O | -- | -1.0 | -- | mV/°C |

ECG963 ($V_{in} = -11\text{ V}$, $I_0 = 500\text{ mA}$, $0^\circ\text{C} < T_{\text{opp}} < +125^\circ\text{C}$ unless otherwise noted.)

| Characteristic | Symbol | Min | Typ | Max | Unit |
|---|----------------------------|-------|------------|------------|---------------|
| Output Voltage ($T_{\text{opp}} = +25^\circ\text{C}$) | V_O | -6.75 | -6.0 | -6.25 | Vdc |
| Line Regulation ($T_{\text{opp}} = +25^\circ\text{C}$, $I_0 = 100\text{ mA}$) -8.0 Vdc $\geq V_{in} \geq -25\text{ Vdc}$ -9.0 Vdc $\geq V_{in} \geq -13\text{ Vdc}$ ($T_{\text{opp}} = +25^\circ\text{C}$, $I_0 = 500\text{ mA}$) -8.0 Vdc $\geq V_{in} \geq -25\text{ Vdc}$ -9.0 Vdc $\geq V_{in} \geq -13\text{ Vdc}$ | Reg_{line} | -- | 9.0 3.0 | 60 30 | mV |
| Load Regulation $T_{\text{opp}} = +25^\circ\text{C}$, $5.0\text{ mA} < I_0 < 1.5\text{ A}$ $250\text{ mA} < I_0 < 750\text{ mA}$ | Reg_{load} | -- | 13 5.0 | 120 60 | mV |
| Output Voltage (-8.0 Vdc $\geq V_{in} \geq -21\text{ Vdc}$, $5.0\text{ mA} < I_0 < 1.0\text{ A}$, $P < 15\text{ W}$) | V_O | -5.7 | -- | -6.3 | Vdc |
| Quiescent Current ($T_{\text{opp}} = +25^\circ\text{C}$) | I_B | -- | 4.3 | 8.0 | mA |
| Quiescent Current Change -8.0 Vdc $\geq V_{in} \geq -25\text{ Vdc}$ $5.0\text{ mA} < I_0 < 1.5\text{ A}$ | ΔI_B | -- | -- | 1.3 0.5 | mA |
| Output Noise Voltage ($T_A = +25^\circ\text{C}$, $10\text{ Hz} < f < 100\text{ kHz}$) | V_N | -- | 45 | -- | μV |
| Long-Term Stability | $\Delta V_O / \Delta t$ | -- | -- | 24 | mV/1.0 k HRS |
| Ripple Rejection ($I_0 = 20\text{ mA}$, $f = 120\text{ Hz}$) | RR | -- | 65 | -- | dB |
| Input-Output Voltage Differential $I_0 = 1.0\text{ A}$, $T_{\text{opp}} = +25^\circ\text{C}$ | $ V_{in} - V_O $ | -- | 2.0 | -- | Vdc |
| Average Temperature Coefficient of Output Voltage $I_0 = 5.0\text{ mA}$, $0^\circ\text{C} < T_A < +125^\circ\text{C}$ | TCV_O | -- | -1.0 | -- | mV/°C |

ECG965 ($V_I = -14\text{ V}$, $I_O = 500\text{ mA}$, $0^\circ\text{C} < T_{\text{opp}} < +125^\circ\text{C}$ unless otherwise noted.)

| Characteristic | Symbol | Min | Typ | Max | Unit |
|---|----------------------------|------|------|------|---------------|
| Output Voltage ($T_{\text{opp}} = +25^\circ\text{C}$) | V_O | -7.7 | -8.0 | -8.3 | Vdc |
| Line Regulation ($T_{\text{opp}} = +25^\circ\text{C}$, $I_O = 100\text{ mA}$) | Reg_{line} | -- | 12 | 80 | mV |
| -10.5 Vdc $> V_I > -25\text{ Vdc}$ | | | 5.0 | 40 | |
| -11 Vdc $> V_I > -17\text{ Vdc}$ | | | | | |
| ($T_{\text{opp}} = +25^\circ\text{C}$, $I_O = 500\text{ mA}$) | Reg_{load} | -- | 50 | 160 | mV |
| -10.5 Vdc $> V_I > -25\text{ Vdc}$ | | | 22 | 80 | |
| -11 Vdc $> V_I > -17\text{ Vdc}$ | | | | | |
| Load Regulation $T_{\text{opp}} = +25^\circ\text{C}$, $5.0\text{ mA} < I_O < 1.5\text{ A}$ $250\text{ mA} < I_O < 750\text{ mA}$ | V_O | -7.6 | -- | -8.4 | Vdc |
| Output Voltage (-10.5 Vdc $> V_I > -23\text{ Vdc}$, $5.0\text{ mA} < I_O < 1.0\text{ A}$, $P < 15\text{ W}$) | I_B | -- | 4.3 | 8.0 | mA |
| Quiescent Current ($T_{\text{opp}} = +25^\circ\text{C}$) | ΔI_B | -- | -- | 1.0 | mA |
| Quiescent Current Change -10.5 Vdc $> V_I > -25\text{ Vdc}$ $5.0\text{ mA} < I_O < 1.5\text{ A}$ | V_N | -- | 52 | -- | μV |
| Output Noise Voltage ($T_A = +25^\circ\text{C}$, $10\text{ Hz} < f < 100\text{ kHz}$) | $\Delta V_O / \Delta t$ | -- | -- | 32 | mV/1.0 k HRS |
| Long-Term Stability | RR | -- | 62 | -- | dB |
| Ripple Rejection ($I_O = 20\text{ mA}$, $f = 120\text{ Hz}$) | $ V_{\text{in}} - V_O $ | -- | 2.0 | -- | Vdc |
| Input-Output Voltage Differential ($I_O = 1.0\text{ A}$, $T_{\text{opp}} = +25^\circ\text{C}$) | TCV _O | -- | -1.0 | -- | mV/°C |
| Average Temperature Coefficient of Output Voltage $I_O = 5\text{ mA}$, $0^\circ\text{C} < T_A < +125^\circ\text{C}$ | | | | | |

T-58-11-13

ECG967 ($V_{\text{in}} = -19\text{ V}$, $I_O = 500\text{ mA}$, $0^\circ\text{C} < T_{\text{opp}} < +125^\circ\text{C}$ unless otherwise noted.)

| Characteristic | Symbol | Min | Typ | Max | Unit |
|---|----------------------------|-------|------|-------|---------------|
| Output Voltage ($T_{\text{opp}} = +25^\circ\text{C}$) | V_O | -11.5 | -12 | -12.5 | Vdc |
| Line Regulation ($T_{\text{opp}} = +25^\circ\text{C}$, $I_O = 100\text{ mA}$) | Reg_{line} | -- | 13 | 120 | mV |
| -14.5 Vdc $> V_{\text{in}} > -30\text{ Vdc}$ | | | 6.0 | 60 | |
| -16 Vdc $> V_{\text{in}} > -22\text{ Vdc}$ | | | | | |
| ($T_{\text{opp}} = +25^\circ\text{C}$, $I_O = 500\text{ mA}$) | Reg_{load} | -- | 55 | 240 | mV |
| -14.5 Vdc $> V_{\text{in}} > -30\text{ Vdc}$ | | | 24 | 120 | |
| -16 Vdc $> V_{\text{in}} > -22\text{ Vdc}$ | | | | | |
| Load Regulation $T_{\text{opp}} = +25^\circ\text{C}$, $5.0\text{ mA} < I_O < 1.5\text{ A}$ $250\text{ mA} < I_O < 750\text{ mA}$ | V_O | -11.4 | -- | -12.6 | Vdc |
| Output Voltage (-14.5 Vdc $> V_{\text{in}} > -27\text{ Vdc}$, $5.0\text{ mA} < I_O < 1.0\text{ A}$, $P < 15\text{ W}$) | I_B | -- | 4.4 | 8.0 | mA |
| Quiescent Current ($T_{\text{opp}} = +25^\circ\text{C}$) | ΔI_B | -- | -- | 1.0 | mA |
| Quiescent Current Change -14.5 Vdc $> V_{\text{in}} > -30\text{ Vdc}$ $5.0\text{ mA} < I_O < 1.5\text{ A}$ | V_N | -- | 75 | -- | μV |
| Output Noise Voltage ($T_A = +25^\circ\text{C}$, $10\text{ Hz} < f < 100\text{ kHz}$) | $\Delta V_O / \Delta t$ | -- | -- | 48 | mV/1.0 k HRS |
| Long-Term Stability | RR | -- | 61 | -- | dB |
| Ripple Rejection ($I_O = 20\text{ mA}$, $f = 120\text{ Hz}$) | $ V_{\text{in}} - V_O $ | -- | 2.0 | -- | Vdc |
| Input-Output Voltage Differential ($I_O = 1.0\text{ A}$, $T_{\text{opp}} = +25^\circ\text{C}$) | TCV _O | -- | -1.0 | -- | mV/°C |
| Average Temperature Coefficient of Output Voltage $I_O = 5.0\text{ mA}$, $0^\circ\text{C} < T_A < +125^\circ\text{C}$ | | | | | |

ECG969 ($V_{in} = -23$ V, $I_O = 500$ mA, $0^\circ\text{C} < T_{\text{opp}} < +125^\circ\text{C}$ unless otherwise noted.)

| Characteristic | Symbol | Min | Typ | Max | Unit |
|---|----------------------------|--------|------|--------|----------------------|
| Output Voltage ($T_{\text{opp}} = +25^\circ\text{C}$) | V_O | -14.4 | -15 | -15.6 | Vdc |
| Line Regulation | Reg_{line} | | | | mV |
| ($T_{\text{opp}} = +25^\circ\text{C}$, $I_O = 100$ mA) | | | 14 | 150 | |
| -17.5 Vdc $\geq V_{in} > -30$ Vdc | | | 6.0 | 75 | |
| -20 Vdc $\geq V_{in} > -26$ Vdc | | | | | |
| ($T_{\text{opp}} = +25^\circ\text{C}$, $I_O = 500$ mA) | | | 57 | 300 | |
| -17.5 Vdc $\geq V_{in} > -30$ Vdc | | | 27 | 150 | |
| -20 Vdc $\geq V_{in} > -26$ Vdc | | | | | |
| Load Regulation | Reg_{load} | | | | mV |
| $T_{\text{opp}} = +25^\circ\text{C}$, 5.0 mA $\leq I_O \leq 1.5$ A | | | 68 | 300 | |
| 250 mA $\leq I_O \leq 750$ mA | | | 25 | 150 | |
| Output Voltage | V_O | | | | Vdc |
| (-17.5 Vdc $\geq V_{in} > -30$ Vdc, | | -14.25 | | -15.75 | |
| 5.0 mA $\leq I_O \leq 1.0$ A, $P \leq 15$ W) | | | | | |
| Quiescent Current ($T_{\text{opp}} = +25^\circ\text{C}$) | I_B | | 4.4 | 8.0 | mA |
| Quiescent Current Change | ΔI_B | | | 1.0 | mA |
| -17.5 Vdc $\geq V_{in} > -30$ Vdc | | | | 0.5 | |
| 5.0 mA $\leq I_O \leq 1.5$ A | | | | | |
| Output Noise Voltage | V_N | | 90 | | μV |
| ($T_A = +25^\circ\text{C}$, 10 Hz $\leq f \leq 100$ kHz) | | | | | |
| Long-Term Stability | $\Delta V_O / \Delta t$ | | | 60 | mV/1.0 k HRS |
| Ripple Rejection ($I_O = 20$ mA, $f = 120$ Hz) | RR | | 60 | | dB |
| Input-Output Voltage Differential | $ V_{in} - V_O $ | | 2.0 | | Vdc |
| ($I_O = 1.0$ A, $T_{\text{opp}} = +25^\circ\text{C}$) | | | | | |
| Average Temperature Coefficient of Output Voltage | TCV_O | | | | mV/ $^\circ\text{C}$ |
| $I_O = 5.0$ mA, $0^\circ\text{C} \leq T_A \leq +125^\circ\text{C}$ | | | -1.0 | | |

T-58-11-13

ECG971 ($V_I = -33$ V, $I_O = 500$ mA, $0^\circ\text{C} < T_{\text{opp}} < +125^\circ\text{C}$ unless otherwise noted.)

| Characteristic | Symbol | Min | Typ | Max | Unit |
|---|----------------------------|-------|------|-------|----------------------|
| Output Voltage ($T_{\text{opp}} = +25^\circ\text{C}$) | V_O | -23 | -24 | -25 | Vdc |
| Line Regulation | Reg_{line} | | | | mV |
| ($T_{\text{opp}} = +25^\circ\text{C}$, $I_O = 100$ mA) | | | 31 | 240 | |
| -27 Vdc $\geq V_I > -38$ Vdc | | | 14 | 120 | |
| -30 Vdc $\geq V_I > -36$ Vdc | | | | | |
| ($T_{\text{opp}} = +25^\circ\text{C}$, $I_O = 500$ mA) | | | 118 | 480 | |
| -27 Vdc $\geq V_I > -38$ Vdc | | | 70 | 240 | |
| -30 Vdc $\geq V_I > -36$ Vdc | | | | | |
| Load Regulation | Reg_{load} | | | | mV |
| $T_{\text{opp}} = +25^\circ\text{C}$, 5.0 mA $\leq I_O \leq 1.0$ A | | | 150 | 480 | |
| 250 mA $\leq I_O \leq 750$ mA | | | 85 | 240 | |
| Output Voltage | V_O | | | | Vdc |
| (-27 Vdc $\geq V_I > -38$ Vdc, | | -22.8 | | -25.2 | |
| 5.0 mA $\leq I_O \leq 1.0$ A, $P \leq 15$ W) | | | | | |
| Quiescent Current ($T_{\text{opp}} = +25^\circ\text{C}$) | I_B | | 4.6 | 8.0 | mA |
| Quiescent Current Change | ΔI_B | | | 1.0 | mA |
| -27 Vdc $\geq V_I > -38$ Vdc | | | | 0.5 | |
| 5.0 mA $\leq I_O \leq 1.0$ A | | | | | |
| Output Noise Voltage | V_N | | 170 | | μV |
| ($T_A = +25^\circ\text{C}$, 10 Hz $\leq f \leq 100$ kHz) | | | | | |
| Long-Term Stability | $\Delta V_O / \Delta t$ | | | 96 | mV/1.0 k HRS |
| Ripple Rejection ($I_O = 20$ mA, $f = 120$ Hz) | RR | | 56 | | dB |
| Input-Output Voltage Differential | $ V_{in} - V_O $ | | 2.0 | | Vdc |
| ($I_O = 1.0$ A, $T_{\text{opp}} = +25^\circ\text{C}$) | | | | | |
| Average Temperature Coefficient of Output Voltage | TCV_O | | | | mV/ $^\circ\text{C}$ |
| $I_O = 5.0$ mA, $0^\circ\text{C} \leq T_A \leq +125^\circ\text{C}$ | | | -1.0 | | |

T-58-11-13

TYPICAL CHARACTERISTICS
($T_A = +25^\circ\text{C}$ unless otherwise noted.)

FIGURE 1 - MAXIMUM AVERAGE POWER DISSIPATION AS A FUNCTION OF AMBIENT TEMPERATURE

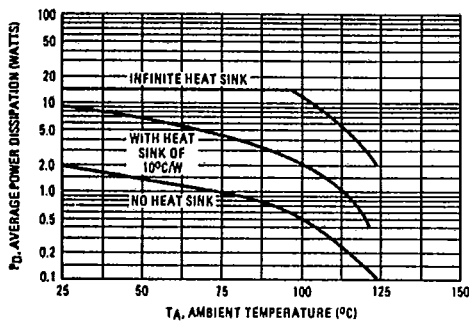

FIGURE 2 - PEAK OUTPUT CURRENT AS A FUNCTION OF INPUT-OUTPUT DIFFERENTIAL VOLTAGE

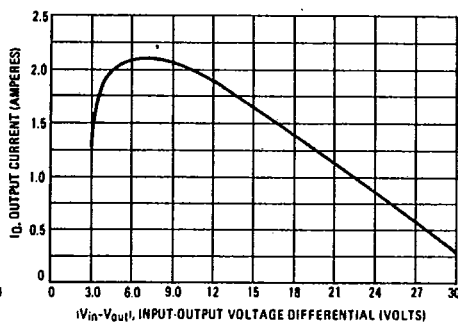

FIGURE 3 - RIPPLE REJECTION AS A FUNCTION OF FREQUENCY

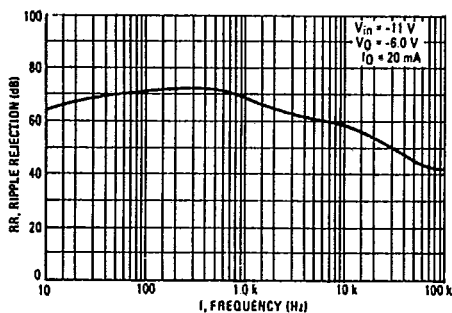

FIGURE 4 - RIPPLE REJECTION AS A FUNCTION OF OUTPUT VOLTAGES

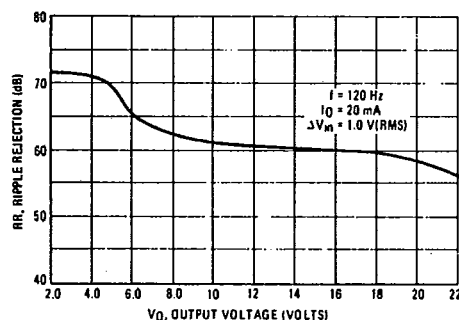

FIGURE 5 - OUTPUT VOLTAGE AS A FUNCTION OF JUNCTION TEMPERATURE

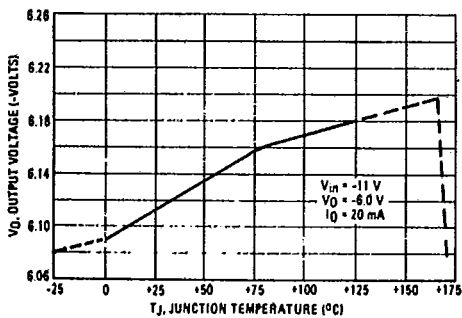
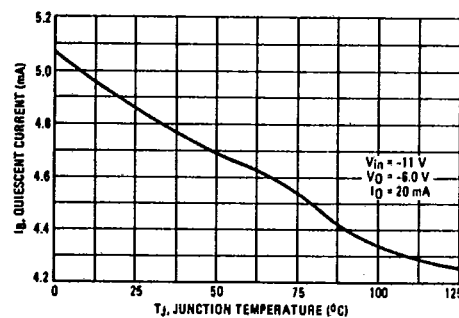

FIGURE 6 - QUIESCENT CURRENT AS A FUNCTION OF TEMPERATURE



Applications Information

T-58-11-13

Design Considerations

These fixed voltage regulators are designed with Thermal Overload Protection that shuts down the circuit when subjected to an excessive power overload condition. Internal Short-Circuit Protection that limits the maximum current the circuit will pass, and Output Transistor Safe-Area Compensation that reduces the output short-circuit current as the voltage across the pass transistor is increased.

In many low current applications, compensation capacitors are not required. However, it is recommended that the regulator input be bypassed with a capacitor if the regulator is connected to the power supply filter with long wire lengths, or if the output load

capacitance is large. An input bypass capacitor should be selected to provide good high frequency characteristics to insure stable operation under all load conditions. A 33 μF or larger tantalum, mylar, or other capacitor having low internal impedance at high frequencies should be chosen. If an aluminum electrolytic capacitor is used, its value should be 1.0 μF or larger. The bypass capacitor should be mounted with the shortest possible leads directly across the regulators input terminals. Normally good construction techniques should be used to minimize ground loops and lead resistance drops since the regulator has no external sense lead. Bypassing the output is also recommended.

Typical Applications ($T_A = +25^\circ\text{C}$ unless otherwise noted)

Standard Application

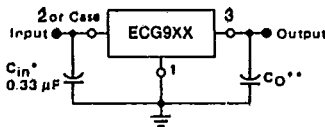

A common ground is required between the input and the output voltages. The input voltage must remain typically 2.0 V more negative even during the high point on the input ripple voltage.

** C_O improves stability and transient response

* C_{in} is required if regulator is located an appreciable distance from power supply filter.

CURRENT BOOST REGULATOR
(-5.0 V @ 4.0 A, with 5.0 A current limiting)

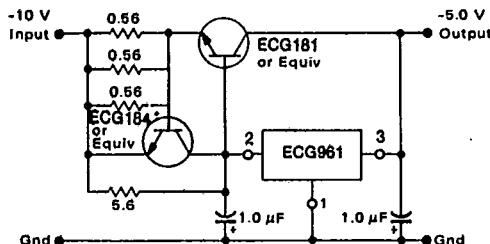

When a boost transistor is used, short-circuit currents are equal to the sum of the series pass and regulator limits, which are measured at 3.2 A and 1.8 A respectively in this case. Series pass limiting is approximately equal to $0.6 \text{ V}/R_{SC}$. Operation beyond this point to the peak current capability of the ECG961 is possible if the regulator is mounted on a heat sink; otherwise thermal shutdown will occur when the additional load current is picked up by the regulator.

* Mounted on common heat sink

OPERATIONAL AMPLIFIER SUPPLY
 (±15 V @ 1.0 A)

T-58-11-13

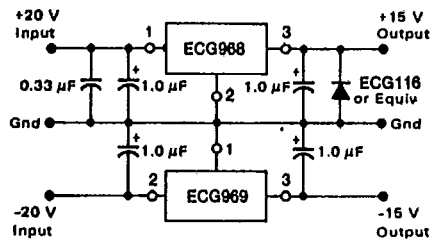

The ECG968 and ECG969 positive and negative regulators may be connected as shown to obtain a dual power supply for operational amplifiers. A clamp diode should be used at the output of the ECG968 to prevent potential latch-up problems.