

## PROTECTION PRODUCTS

### Description

The SL series of TVS arrays are designed to protect sensitive electronics from damage or latch-up due to ESD, lightning, and other voltage-induced transient events. They are available with operating voltages of 5V, 12V, 15V and 24V.

TVS diodes are solid-state devices designed specifically for transient suppression. They offer desirable characteristics for board level protection including fast response time, low operating and clamping voltage, and no device degradation. The SL series devices feature a low capacitance, fast switching compensation diode in series with a standard TVS diode. This effectively reduces the overall capacitance of the device to less than 5pF making it an integrated, low capacitance solution for use on high-speed interfaces.

The SL series devices may be used to meet the immunity requirements of IEC 61000-4-2, level 4.

### Features

- ◆ Transient protection for high-speed data lines to **IEC 61000-4-2 (ESD)  $\pm 15\text{kV}$  (air),  $\pm 8\text{kV}$  (contact)**  
**IEC 61000-4-4 (EFT) 40A (5/50ns)**  
**IEC 61000-4-5 (Lightning) 12A (8/20 $\mu\text{s}$ )**
- ◆ Small package for use in portable electronics
- ◆ Two devices will protect one line
- ◆ Low capacitance for high-speed data lines
- ◆ Working voltages: 5V, 12V, 15V and 24V
- ◆ Solid-state silicon avalanche technology

### Mechanical Characteristics

- ◆ JEDEC SOT23 package
- ◆ Molding compound flammability rating: UL 94V-0
- ◆ Marking : Marking Code
- ◆ Packaging : Tape and Reel per EIA 481

### Applications

- ◆ High-Speed data lines
- ◆ Cellular handsets AND accessories
- ◆ Universal Serial Bus (USB) port protection
- ◆ Portable instrumentation
- ◆ LAN/WAN equipment
- ◆ Peripherals

### Circuit Diagram

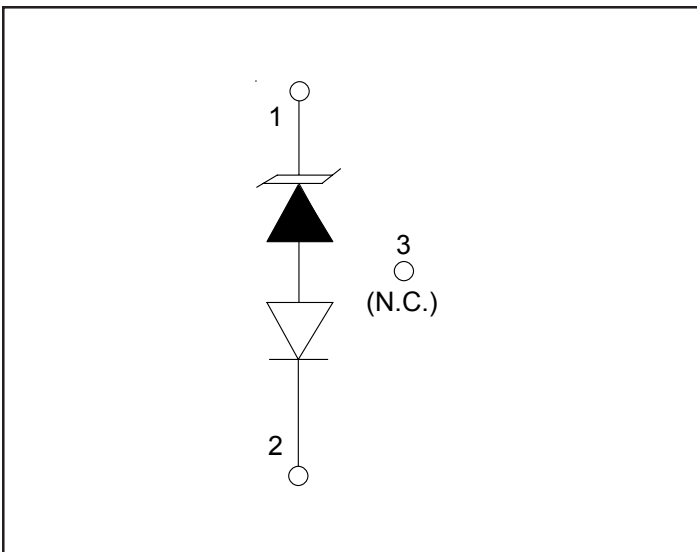

### Schematic & PIN Configuration

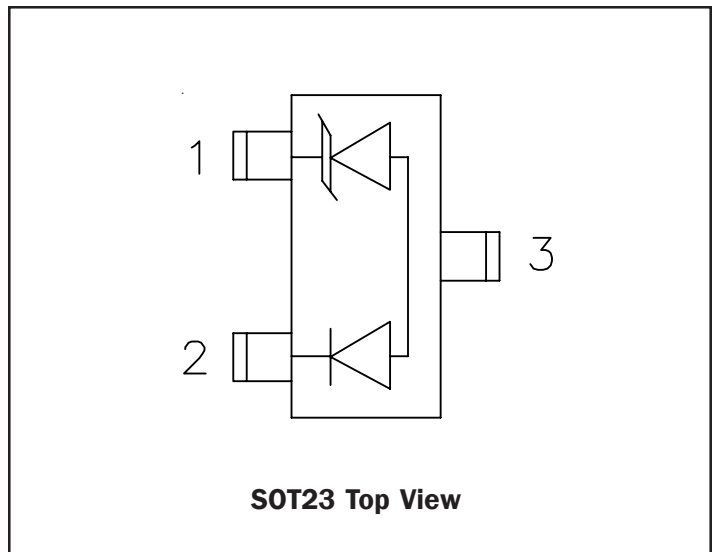

**PROTECTION PRODUCTS**
**Absolute Maximum Rating**

Rating	Symbol	Value	Units
Peak Pulse Power ( $t_p = 8/20\mu s$ )	$P_{pk}$	300	Watts
ESD Voltage (HBM per IEC 61000-4-2)	$V_{ESD}$	>25	kV
Lead Soldering Temperature	$T_L$	260 (10 sec.)	°C
Operating Temperature	$T_J$	-55 to +125	°C
Storage Temperature	$T_{STG}$	-55 to +150	°C

**Electrical Characteristics**
**SL05**

Parameter	Symbol	Conditions	Minimum	Typical	Maximum	Units
Reverse Stand-Off Voltage	$V_{RWM}$				5	V
Reverse Breakdown Voltage	$V_{BR}$	$I_t = 1mA$	6			V
Reverse Leakage Current	$I_R$	$V_{RWM} = 5V, T=25^\circ C$			20	$\mu A$
Clamping Voltage	$V_C$	$I_{PP} = 1A,$ $t_d = 8/20\mu s$			9.8	V
Clamping Voltage	$V_C$	$I_{PP} = 5A,$ $t_d = 8/20\mu s$			11	V
Peak Pulse Current	$I_{PP}$	$t_d = 8/20\mu s$			17	A
Junction Capacitance	$C_J$	Pin 1 to 2 $V_R = 0V, f = 1MHz$			5	pF

**SL12**

Parameter	Symbol	Conditions	Minimum	Typical	Maximum	Units
Reverse Stand-Off Voltage	$V_{RWM}$				12	V
Reverse Breakdown Voltage	$V_{BR}$	$I_t = 1mA$	13.3			V
Reverse Leakage Current	$I_R$	$V_{RWM} = 12V, T=25^\circ C$			1	$\mu A$
Clamping Voltage	$V_C$	$I_{PP} = 1A,$ $t_d = 8/20\mu s$			19	V
Clamping Voltage	$V_C$	$I_{PP} = 5A,$ $t_d = 8/20\mu s$			24	V
Peak Pulse Current	$I_{PP}$	$t_d = 8/20\mu s$			12	A
Junction Capacitance	$C_J$	Pin 1 to 2 $V_R = 0V, f = 1MHz$			5	pF

**PROTECTION PRODUCTS**
**Electrical Characteristics (Continued)**

<b>SL15</b>						
<b>Parameter</b>	<b>Symbol</b>	<b>Conditions</b>	<b>Minimum</b>	<b>Typical</b>	<b>Maximum</b>	<b>Units</b>
Reverse Stand-Off Voltage	$V_{RWM}$				15	V
Reverse Breakdown Voltage	$V_{BR}$	$I_t = 1mA$	16.7			V
Reverse Leakage Current	$I_R$	$V_{RWM} = 15V, T=25^\circ C$			1	$\mu A$
Clamping Voltage	$V_C$	$I_{PP} = 1A,$ $t_p = 8/20\mu s$			24	V
Clamping Voltage	$V_C$	$I_{PP} = 5A,$ $t_p = 8/20\mu s$			30	V
Peak Pulse Current	$I_{PP}$	$t_p = 8/20\mu s$			10	A
Junction Capacitance	$C_j$	Pin 1 to 2 $V_R = 0V, f = 1MHz$			5	pF

<b>SL24</b>						
<b>Parameter</b>	<b>Symbol</b>	<b>Conditions</b>	<b>Minimum</b>	<b>Typical</b>	<b>Maximum</b>	<b>Units</b>
Reverse Stand-Off Voltage	$V_{RWM}$				24	V
Reverse Breakdown Voltage	$V_{BR}$	$I_t = 1mA$	26.7			V
Reverse Leakage Current	$I_R$	$V_{RWM} = 24V, T=25^\circ C$			1	$\mu A$
Clamping Voltage	$V_C$	$I_{PP} = 1A,$ $t_p = 8/20\mu s$			43	V
Clamping Voltage	$V_C$	$I_{PP} = 5A,$ $t_p = 8/20\mu s$			55	V
Peak Pulse Current	$I_{PP}$	$t_p = 8/20\mu s$			5	A
Junction Capacitance	$C_j$	Pin 1 to 2 $V_R = 0V, f = 1MHz$			5	pF

PROTECTION PRODUCTS

Typical Characteristics

Non-Repetitive Peak Pulse Power vs. Pulse Time

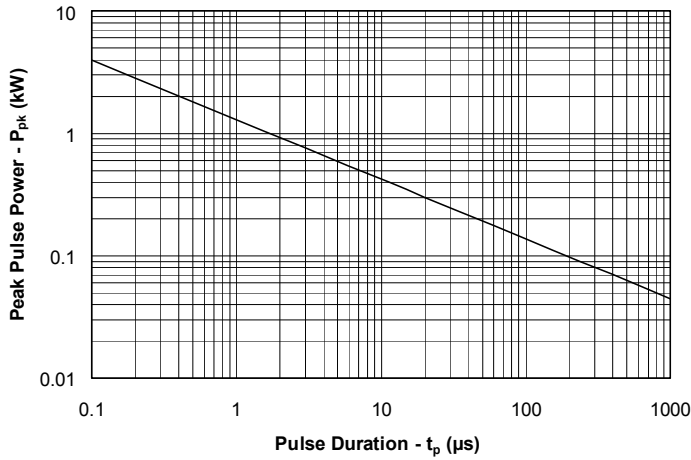

Power Derating Curve

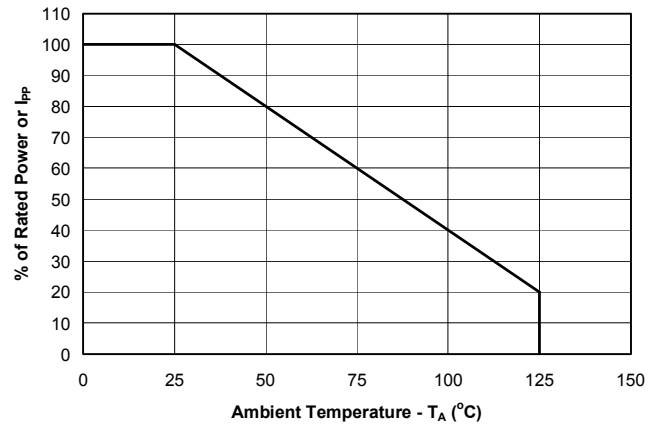

Pulse Waveform

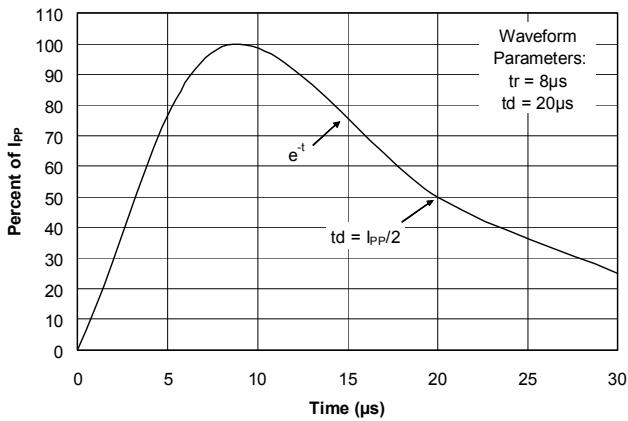

ESD Pulse Waveform (Per IEC 61000-4-2)

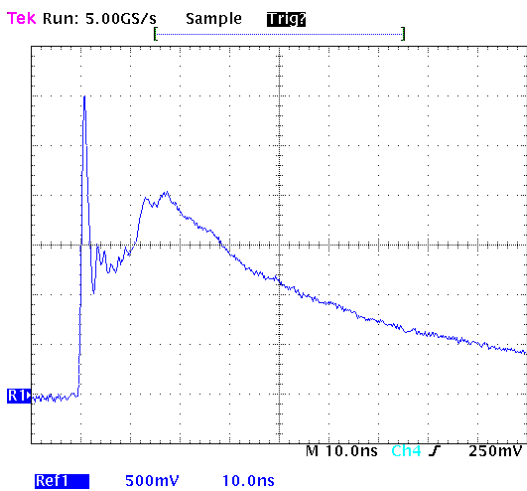

IEC 61000-4-2 Discharge Parameters

Level	First Peak Current (A)	Peak Current at 30 ns (A)	Peak Current at 60 ns (A)	Test Voltage (Contact Discharge) (kV)	Test Voltage (Air Discharge) (kV)
1	7.5	4	8	2	2
2	15	8	4	4	4
3	22.5	12	6	6	8
4	30	16	8	8	15

## PROTECTION PRODUCTS

### Applications Information

#### Device Connection for Protection of One High-Speed Data Line

The SL series devices are designed to protect high-speed data lines. The SLxx utilizes a low capacitance compensation diode in series with, but in opposite polarity to a TVS diode in each line to achieve an effective capacitance of less than 5pF per device. During a transient event, the internal rectifier must be forward biased (TVS is reversed biased). Therefore, each device will only suppress transient events in one polarity. To achieve protection in both positive and negative polarity, a second device is connected in anti-parallel to the first. On unidirectional lines, a fast switching steering diode may be used as an alternative to using two SL devices.

The options for connecting the devices are as follows:

- Low capacitance protection of one high-speed line:** Protection of one unidirectional or bidirectional high-speed line is achieved by connecting two devices in anti-parallel. Pin 1 of the first device is connected to the line and pin 2 is connected to ground (or to a second line for differential protection). Pin 2 of the second device is connected to line 1 and pin 1 is connected to ground (or line 2) as shown. Pin 3 is not connected. During positive duration transients, the first device will conduct from pin 1 to 2. The steering diode conducts in the forward direction while the TVS will avalanche and conduct in the reverse direction. During negative transients, the second device will conduct in the same manner. For optimum protection, the ground connections should be made directly to the ground plane for best results. The path length is kept as short as possible to reduce the effects of parasitic inductance in the board traces. The path length between the TVS and the protected line should also be minimized.
- Connection Option for Unidirectional Lines Only:** An optional method for protecting unidirectional (normal signal polarities above ground) lines is to add a fast switching steering diode in parallel to the SL TVS. Input/outputs are connected to pin 1 of the SL device and the cathode of the rectifier. The anode of the diode and pin 2 of the SL TVS are connected to ground.

#### SL Connection Options

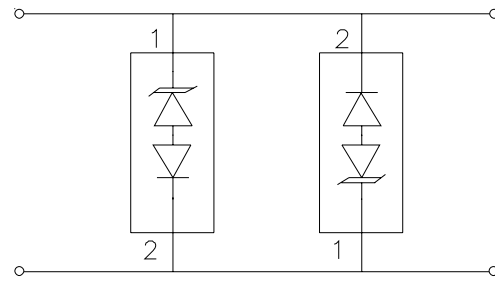

Two Devices : Bidirectional or Unidirectional Line

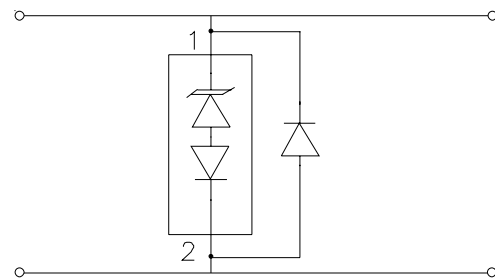

One Devices with Steering Diode : Unidirectional Line

#### I/O Line Protection

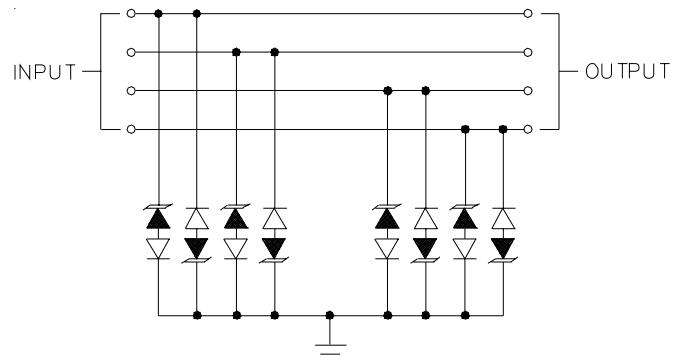

#### Matte Tin Lead Finish

Matte tin has become the industry standard lead-free replacement for SnPb lead finishes. A matte tin finish is composed of 100% tin solder with large grains. Since the solder volume on the leads is small compared to the solder paste volume that is placed on the land pattern of the PCB, the reflow profile will be determined by the requirements of the solder paste. Therefore, these devices are compatible with both lead-free and SnPb assembly techniques. In addition, unlike other lead-free compositions, matte tin does not have any added alloys that can cause degradation of the solder joint.

## PROTECTION PRODUCTS

### Outline Drawing - SOT23 3L

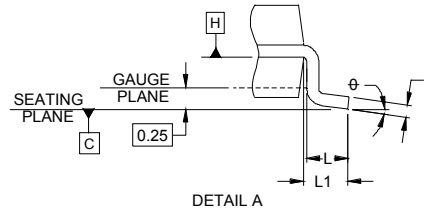
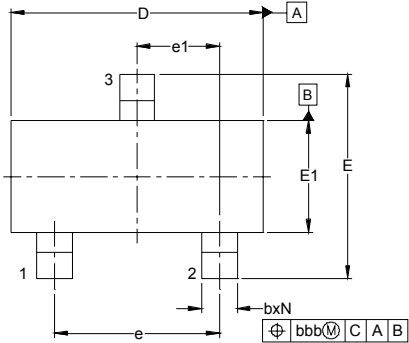

DIM	INCHES			MILLIMETERS		
	MIN	NOM	MAX	MIN	NOM	MAX
A	.035	-	.044	0.89	-	1.12
A1	.000	-	.004	0.01	-	0.10
A2	.035	.037	.040	0.88	0.95	1.02
b	.012	-	.020	0.30	-	0.51
c	.003	-	.007	0.08	-	0.18
D	.110	.114	.120	2.80	2.90	3.04
E	.082	.093	.104	2.10	2.37	2.64
E1	.047	.051	.055	1.20	1.30	1.40
e	.075	-	-	1.90	BSC	-
e1	.037	-	-	0.95	BSC	-
L	.015	.020	.024	0.40	0.50	0.60
L1	.022	-	-	(0.55)	-	-
N	3	-	-	3	-	-
$\phi$	0°	-	8°	0°	-	8°
aaa	.004	-	-	0.10	-	-
bbb	.008	-	-	0.20	-	-

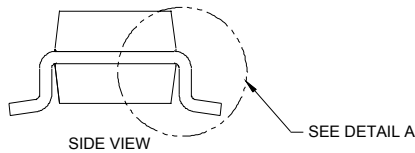
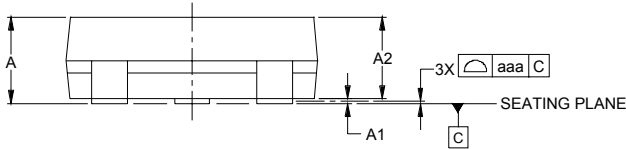

**NOTES:**

1. CONTROLLING DIMENSIONS ARE IN MILLIMETERS (ANGLES IN DEGREES).
2. DATUMS **-A-** AND **-B-** TO BE DETERMINED AT DATUM PLANE **-H-**
3. DIMENSIONS "E1" AND "D" DO NOT INCLUDE MOLD FLASH, PROTRUSIONS OR GATE BURRS.

### Land Pattern - SOT23 3L

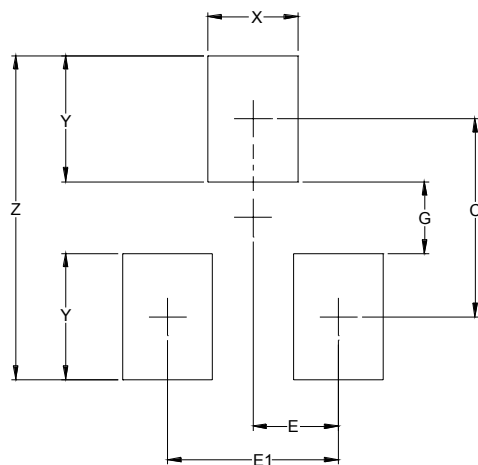

DIMENSIONS		
DIM	INCHES	MILLIMETERS
C	(.087)	(2.20)
E	.037	0.95
E1	.075	1.90
G	.031	0.80
X	.039	1.00
Y	.055	1.40
Z	.141	3.60

**NOTES:**

1. THIS LAND PATTERN IS FOR REFERENCE PURPOSES ONLY CONSULT YOUR MANUFACTURING GROUP TO ENSURE YOUR COMPANY'S MANUFACTURING GUIDELINES ARE MET.
2. REFERENCE IPC-SM-782A.

**PROTECTION PRODUCTS****Marking Codes**

<b>Part Number</b>	<b>Marking Code</b>
SL05	L05
SL12	L12
SL15	L15
SL24	L24

**Ordering Information**

<b>Part Number</b>	<b>Lead Finish</b>	<b>Qty per Reel</b>	<b>Reel Size</b>
SL05.TC	SnPb	3,000	7 Inch
SL12.TC	SnPb	3,000	7 Inch
SL15.TC	SnPb	3,000	7 Inch
SL24.TC	SnPb	3,000	7 Inch
SL05.TCT	Pb Free	3,000	7 Inch
SL12.TCT	Pb Free	3,000	7 Inch
SL15.TCT	Pb Free	3,000	7 Inch
SL24.TCT	Pb Free	3,000	7 Inch

**Contact Information**

Semtech Corporation  
Protection Products Division  
200 Flynn Road, Camarillo, CA 93012  
Phone: (805)498-2111 FAX (805)498-3804

# Mouser Electronics

Authorized Distributor

Click to View Pricing, Inventory, Delivery & Lifecycle Information:

[Semtech:](#)

[SL05.TCT](#) [SL12.TCT](#) [SL24.TCT](#) [SL15.TCT](#)