

# C&K ZM Series Subminiature Snap-acting Switches



## Features/Benefits

- **Reliable snap-acting mechanism**
- **Long electrical and mechanical life**
- **Compact size—Ideal when space is limited**
- **Various PCB terminals and actuators**
- **RoHS compatible**

## Typical Applications

- **PCB detection switch**
- **Communication devices**
- **Testing equipment**
- **Security/Alarm systems**
- **Consumer electronics**

## Specifications

CONTACT RATING: F7: 3A @ 125 VAC; 1.5A @ 250 VAC  
M9: 0.2A @ 60 VDC.

ELECTRICAL LIFE: 15,000 Cycles. @ 3A

INSULATION RESISTANCE: 100 M ohm min.

DIELECTRIC STRENGTH: 1000 Vrms.

OPERATING TEMPERATURE: -40°F to 185°F (-40°C to 85°C).

OPERATING FORCE: CJ: 150 grams, CH: 90 grams.

\* Low Level=conditions where no arcing occurs during switching, i.e., 0.4 VA max. @ 20 V AC or DC max.

## Materials

CASE: Nylon 6/6

COVER/ACTUATOR: Nylon 6/6

MOVABLE CONTACTS: Silver, gold plated.

STATIONARY CONTACTS: Silver, gold plated.

TERMINALS: Brass, tin plated.

**NOTE:** Specifications and materials listed above are for switches with standard options. For information on specific and custom switches, consult Customer Service Center.

## Build-A-Switch

To order, simply select desired option from each category and place in the appropriate box. Available options are shown and described on pages K-29 and K-30. For additional options not shown in catalog, consult Customer Service Center.

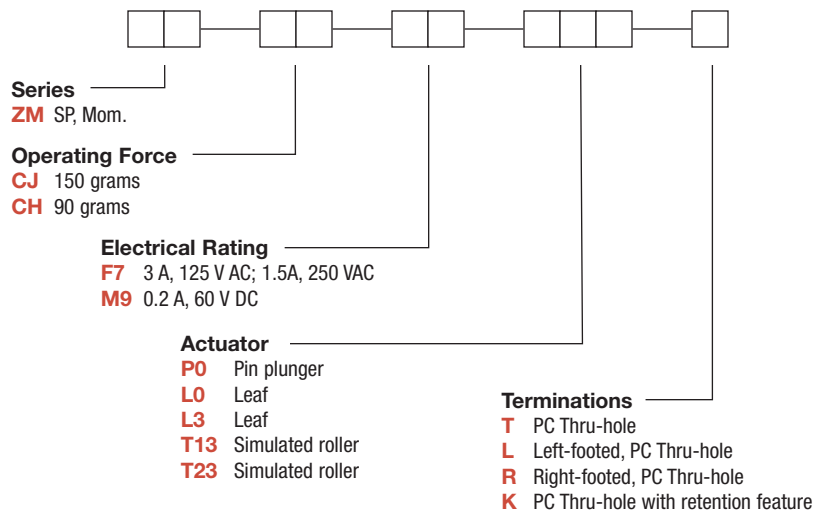

Third Angle  
Projection

Dimensions are shown: Inch (mm)  
Specifications and dimensions subject to change

# C&K ZM Series Subminiature Snap-acting Switches

## SERIES Z M ■ ■ ■ ■ ■ ■ ■ ■

**ZM** SUBMINIATURE SNAP-ACTING SWITCHES – SP MOMENTARY

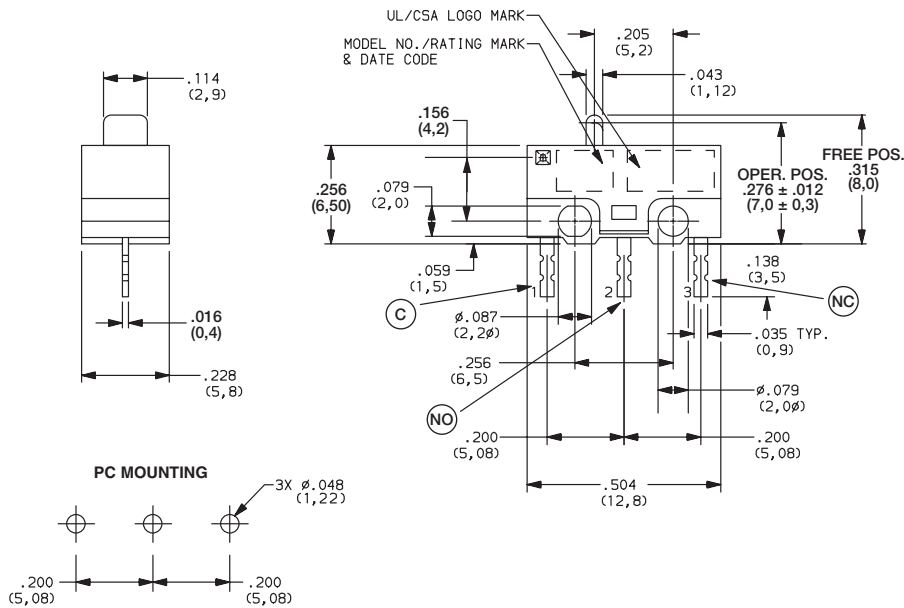

ZMCJF7PL0T  
SPDT



Snap-acting

## OPERATING FORCE ■ ■ ■ ■ ■ ■ ■ ■

OPTION CODE	BASIC SWITCH OPERATING FORCE (OZ./GRAMS)
CJ	5.29 150
CH	3.15 90

## ELECTRICAL RATING ■ ■ ■ ■ ■ ■ ■ ■

OPTION CODE	RoHS COMPLIANT*	RoHS COMPATIBLE*	CONTACT MATERIAL		ELECTRICAL RATING
			MOVABLE CONTACT	STATIONARY CONTACT	
F7	Yes	Yes	Fine Silver	Fine silver	3 AMPS @ 125 V AC; 1.5A @ 250 VAC
M9	Yes	Yes	Gold over fine silver	Gold over fine silver	0.2 AMP @ 60 V DC

\* Note: See Technical Data section of this catalog for RoHS compliant and compatible definition and specifications.

All models with all options.

Consult Customer Service center for availability and delivery of nonstandard ratings.

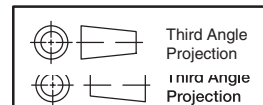

Dimensions are shown: Inch (mm)  
Specifications and dimensions subject to change



# C&K ZM Series Subminiature Snap-acting Switches

## ACTUATOR

**P0** PIN PLUNGER

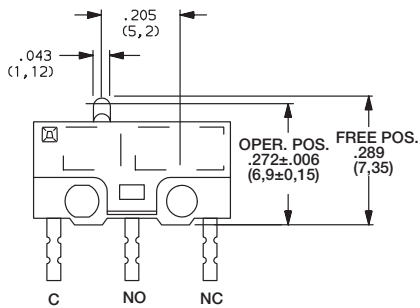

**L0** LEAF, 50 GRAMS (CJ ONLY)

**L3** LEAF, 30 GRAMS (CH ONLY)

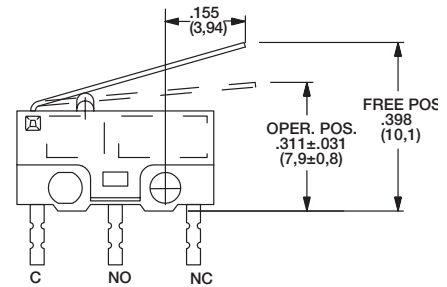

**T13** SIMULATED ROLLER, 40 GRAMS (CJ ONLY)

**T23** SIMULATED ROLLER, 25 GRAMS (CH ONLY)

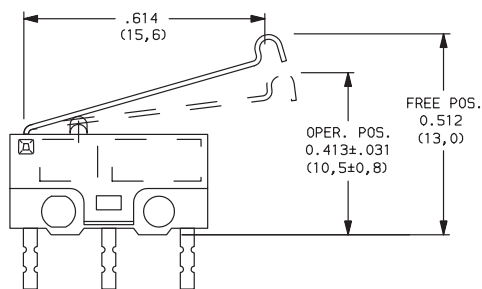

## TERMINATIONS

**T** (STD.) PC THRU-HOLE

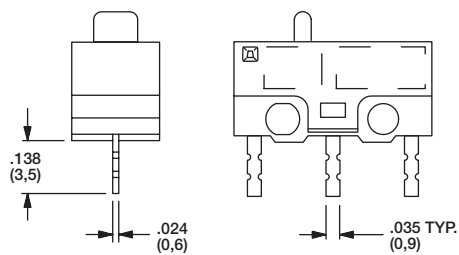

**K** PC THRU-HOLE WITH RETENTION FEATURE

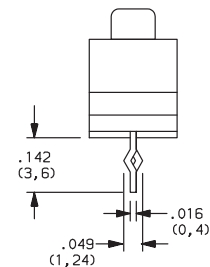

**L** LEFT FOOTED, PC THRU-HOLE

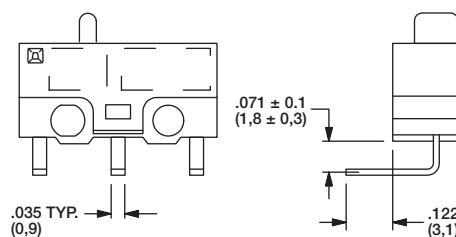

**R** RIGHT FOOTED, PC THRU-HOLE

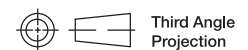
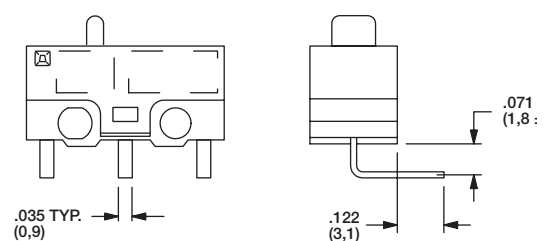

Third Angle Projection  
Dimensions are shown: Inch (mm)  
Specifications and dimensions subject to change



**K**

Snap-acting