

NOTES: UNLESS OTHERWISE SPECIFIED

1.

NOTICE:	THIS IS A RoHS COMPLIANT COMPONENT/PRODUCT. ALL ENGINEERING CHANGES MUST HAVE PRIOR APPROVAL BY THE DESIGN CENTER.
RoHS-6	
	

2. PLASTIC: THERMOSET PLASTIC MATERIAL WITH FLAMMABILITY RATING UL 94V-0 OR BETTER.
3. SOLDERABILITY: CONFORMS TO ANSI/J-STD-002 245°C REFLOW PEAK TEMPERATURE PER IPC/EIA J-STD-003A
4. OPERATING TEMPERATURE: 0°C TO +70°C
5. STORAGE TEMPERATURE: -20°C TO +125°C
6. JEDEC MOISTURE: LEVEL 1.
7. DIMENSIONS ARE IN INCHES [MILLIMETERS] WITH THE FOLLOWING TOLERANCES: [MILLIMETERS] ARE FOR REFERENCE ONLY.  
.XX= ±.01 [±0.25]  
.XXX= ±.005 [±0.13]
8. NOT FOR SALE IN U.S.

ELECTRICAL CHARACTERISTICS:  
ELECTRICAL: @ +25°C

PARAMETER	SPECIFICATIONS		
	100 KHz	1-125 MHz	
INSERTION LOSS	-1.2 dB MAX	-0.2-0.002f <sup>1.4</sup> dB MAX	
RETURN LOSS, 1000BT (Z OUT = 100 OHM ±15%)	.1-30 MHz	30-60 MHz	60-80 MHz
	-16 dB MIN	-10+20*LOG <sub>10</sub> (f/60 MHz) dB MIN	-10 dB MIN
INDUCTANCE (OCL) (MEDIA SIDE, 0°C - 70°C)	350 uH MIN (MEASURED AT 100 KHz, 100 mVRMS AND WITH 8 mA DC BIAS)		
	1 MHz	10-100 MHz	
CROSSTALK, ADJACENT CHANNELS	-50 dB MIN	-55+22*LOG <sub>10</sub> (f/10) dB MIN	
COMMON MODE REJECTION RATIO	2 MHz	30-200 MHz	
	-45 dB MIN	-7+28*LOG <sub>10</sub> (f/200) dB MIN	
DC RESISTANCE, 1/2 WINDING	.65 OHMS MAX		
DC RESISTANCE IMBALANCE	±.065 OHMS MAX (CENTER TAP SYMMETRY)		
INPUT - OUTPUT ISOLATION	1500 VRMS MIN AT 60 SECONDS		

NOTE: f IS FREQUENCY IN MHz.

© Copyright, 2013. Pulse Electronics, Inc. All rights reserved. Drawing specifications subject to change without notice. (10/15/13)

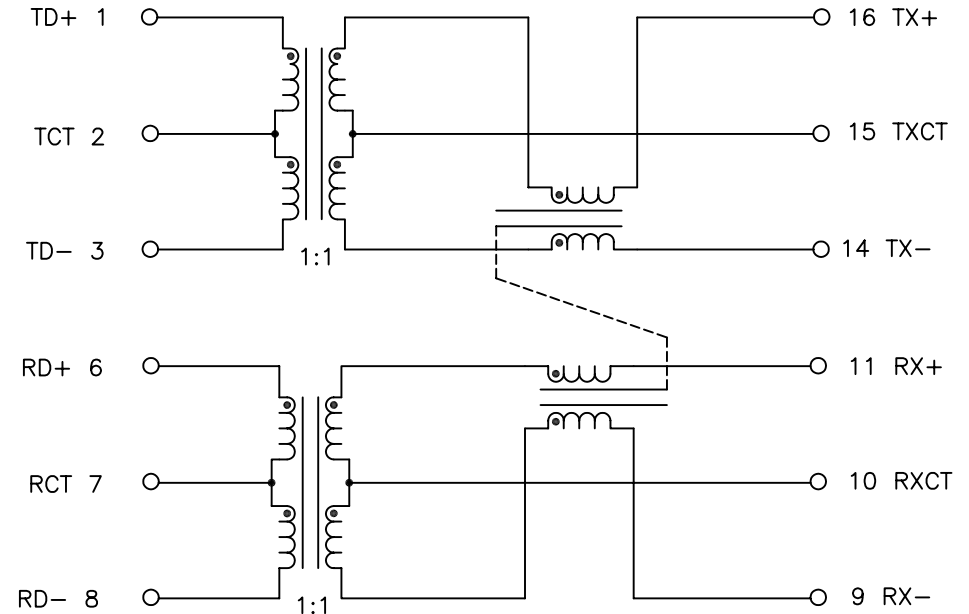
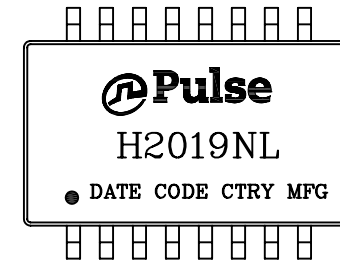

SCHEMATIC

PULSE CONFIDENTIAL  
&  
PROPRIETARY

PRODUCT DESCRIPTION  
MDL,SIN,100P,1:1,SMT

PS DRAWING  
PS-2005.001-D

SHEET:  
1

DWG. NO./ PART NO.  
H2019NL

REV.  
M18

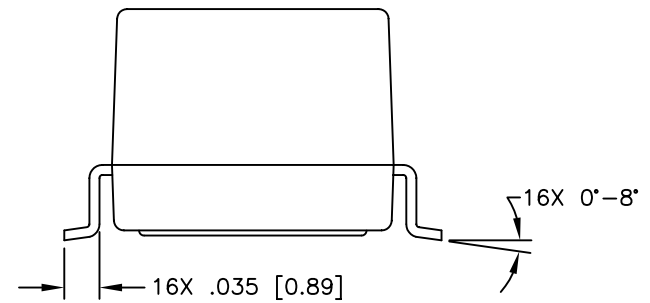
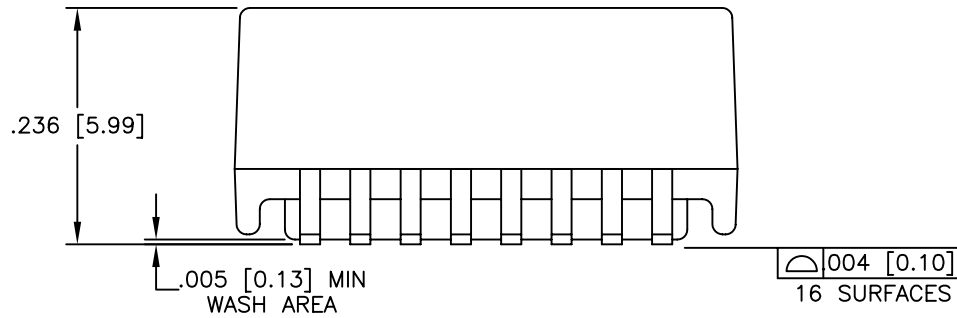
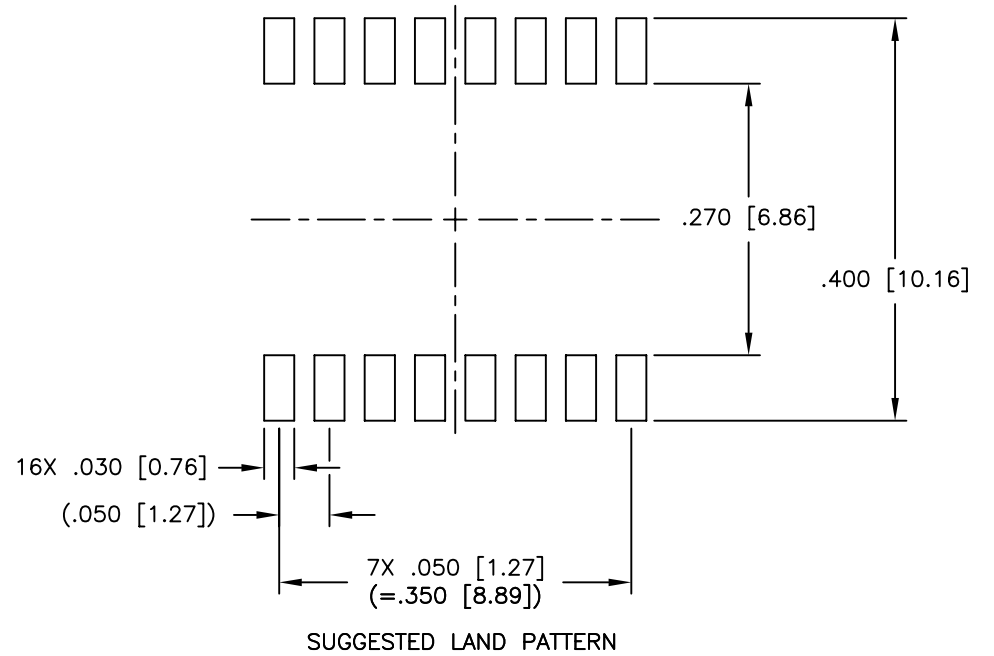
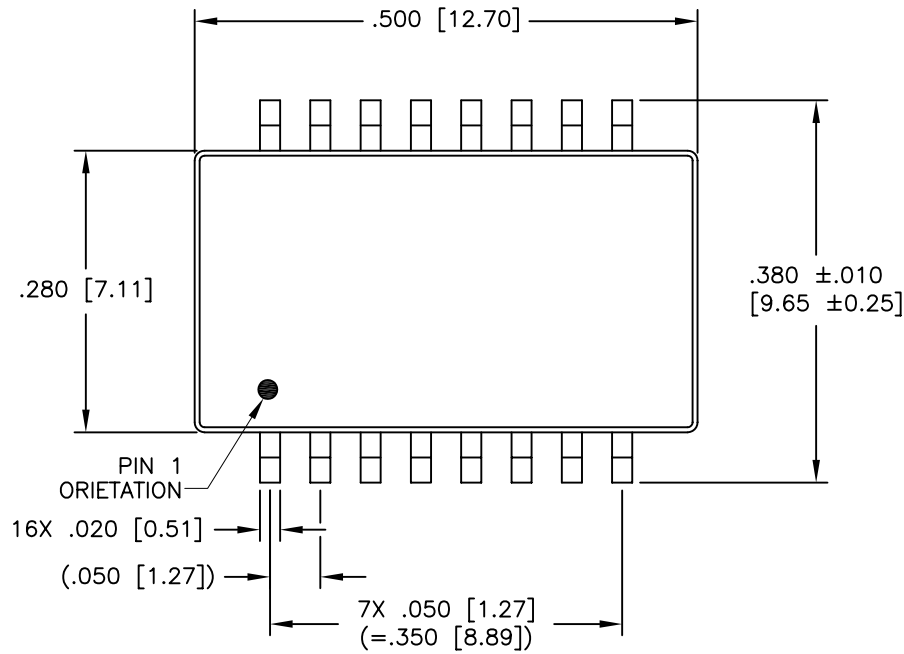

© Copyright, 2013. Pulse Electronics, Inc. All rights reserved. Drawing specifications subject to change without notice. (10/15/13)

PULSE CONFIDENTIAL  
&  
PROPRIETARY

PRODUCT DESCRIPTION  
MDL,SIN,100P,1:1,SMT

PS DRAWING  
PS-2005.001-D

SHEET:  
2

DWG. NO./ PART NO.  
H2019NL

REV.  
M18