

# Telecom Performance TCXO / VCTCXO



2111 Comprehensive Drive  
Aurora, Illinois 60505  
Phone: 630-851-4722  
Fax: 630-851-5040  
**www.conwin.com**

US Headquarters:  
630-851-4722  
European Headquarters:  
+353-61-472221

## Description

The Connor-Winfield 5.0x7.0mm Temperature Compensated Crystal Controlled Oscillators and Voltage Controlled Temperature Compensated Crystal Controlled Oscillators are designed for use in S3 Telecom Applications. Through the use of Analog Temperature Compensation, this device is capable of holding sub 1-ppm stabilities over the commercial or the industrial temperature ranges. All models meet +/-4.6ppm accuracies for twenty years.

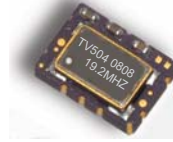

## Features:

Miniature 5.0 x7.0mm Surface Mount Package  
3.3V Operation  
LVCMOS or Clipped Sinewave Output Logic  
Frequency Stabilities Available:  
TV50x / TV60x: +/-0.28ppm  
TV51x / TV61x: +/-0.50ppm  
TV52x / TV62x: +/-1.00ppm  
Temperature Ranges Available:  
TV5xx Series: 0 to 70°C  
TV6xx Series: -40 to 85°C  
Frequency Tolerance: +/-4.60ppm for 20 yrs.  
Low Jitter <1pS RMS  
Tape and Reel Packaging  
RoHS Compliant / Lead Free   
Recommended for New Designs  
Matches Vectron's VTC1-Series Footprint

## Applications

STRATUM 3 Applications  
Timing Reference

## Package Layout

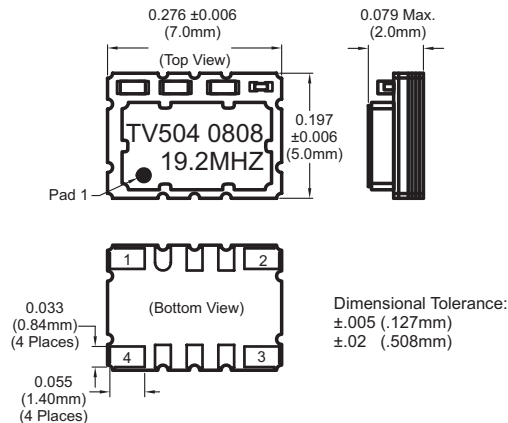

## Pad Connections

1	Control Voltage or N/C
2	Ground
3	Output
4	Supply Voltage (Vcc)

## Standard Frequencies Available \*

6.4 MHz 9.72 MHz 10.0 MHz 10.24 MHz 12.5 MHz 12.8 MHz  
13.5 MHz 19.44 MHz 20.0 MHz 20.48 MHz 25 MHz 27 MHz 38.88 MHz

\* Available frequencies from the factory for small quantity orders or quick delivery. Additional frequencies are available.

## Ordering Information

Table 1.0

TV	5	0	4	-	019.2M
<b>Type:</b> Precision TCXO VCTCXO 5x7mm 4 Pads	<b>Temperature Range:</b> 5 = 0 to 70° C 6 = -40 to 85° C	<b>Frequency Stability:</b> 0 = +/-0.28 ppm 1 = +/- 0.50 ppm 2 = +/- 1.00 ppm	<b>Features:</b> 2 = TCXO, LVCMOS, 3.3Vdc. 3 = TCXO, Clipped Sinewave, 3.3Vdc. 4 = VCTCXO, LVCMOS, 3.3Vdc. 5 = VCTCXO, Clipped Sinewave, 3.3Vdc.		<b>Output Frequency:</b> Frequency Format -xxx.xM Min.* -xxx.xxxxxM Max.* *Amount of numbers after the decimal point. M = MHz

Example:  
TV504-019.2M = 5x7mm, TCXO, LVCMOS, 3.3Vdc, 0 to 70C, +/-0.28ppm, Output Frequency 19.2MHz

To order an TV504 with an output frequency of:  
6.4 MHz = TV504-006.4M  
20 MHz = TV504-020.0M  
38.88 MHz = TV504-038.88M



Bulletin	<b>Tx215</b>
Page	<b>1 of 4</b>
Revision	<b>01</b>
Date	<b>25 Aug 2008</b>

## Absolute Maximum Ratings

Table 2.0

Parameter	Minimum	Nominal	Maximum	Units	Notes
Storage Temperature	-55	-	125	°C	
Supply Voltage (Vcc)	-0.5	-	6.0	Vdc	
Input Voltage (Vcc)	-0.5	-	Vcc+0.6	Vdc	

## Model Specifications

Table 3.0  
Notes

Model Number	TV502	TV503	TV504	TV505	Notes
Output Type	LVC MOS	Clipped Sinewave	LVC MOS	Clipped Sinewave	
TCXO / VCTCXO	TCXO	TCXO	VCTCXO	VCTCXO	
Frequency Range	6.4 to 40 MHz				
Frequency Stability	±0.28ppm				1
Supply Voltage	3.3Vdc				
Temperature Range	0 to 70°C				
Holdover Stability	±0.32ppm				2

Table 4.0  
Notes

Model Number	TV602	TV603	TV604	TV605	Notes
Output Type	LVC MOS	Clipped Sinewave	LVC MOS	Clipped Sinewave	
TCXO / VCTCXO	TCXO	TCXO	VCTCXO	VCTCXO	
Frequency Range	6.4 to 40 MHz				
Frequency Stability	±0.28ppm				1
Supply Voltage	3.3Vdc				
Temperature Range	-40 to 85°C				
Holdover Stability	±0.32ppm				2

Table 5.0  
Notes

Model Number	TV512	TV513	TV514	TV515	Notes
Output Type	LVC MOS	Clipped Sinewave	LVC MOS	Clipped Sinewave	
TCXO / VCTCXO	TCXO	TCXO	VCTCXO	VCTCXO	
Frequency Range	6.4 to 40 MHz				
Frequency Stability	±0.50ppm				1
Supply Voltage	3.3Vdc				
Temperature Range	0 to 70°C				

Table 6.0  
Notes

Model Number	TV612	TV613	TV614	TV615	Notes
Output Type	LVC MOS	Clipped Sinewave	LVC MOS	Clipped Sinewave	
TCXO / VCTCXO	TCXO	TCXO	VCTCXO	VCTCXO	
Frequency Range	6.4 to 40 MHz				
Frequency Stability	±0.50ppm				1
Supply Voltage	3.3Vdc				
Temperature Range	-40 to 85°C				

Table 7.0  
Notes

Model Number	TV522	TV523	TV524	TV525	Notes
Output Type	LVC MOS	Clipped Sinewave	LVC MOS	Clipped Sinewave	
TCXO / VCTCXO	TCXO	TCXO	VCTCXO	VCTCXO	
Frequency Range	6.4 to 52 MHz				
Frequency Stability	±1.00ppm				1
Supply Voltage	3.3Vdc				
Temperature Range	0 to 70°C				

Table 8.0  
Notes

Model Number	TV622	TV623	TV624	TV625	Notes
Output Type	LVC MOS	Clipped Sinewave	LVC MOS	Clipped Sinewave	
TCXO / VCTCXO	TCXO	TCXO	VCTCXO	VCTCXO	
Frequency Range	6.4 to 52 MHz				
Frequency Stability	±1.00ppm				1
Supply Voltage	3.3Vdc				
Temperature Range	-40 to 85°C				

### Notes:

- 1) Frequency stability vs. change in temperature.  $[\pm(F_{max} - F_{min})/2.F_0]$ .
- 2) Inclusive of frequency stability, supply voltage change ( $\pm 1\%$ ), aging, for 24 hours.



## Features

- TCXO
- VCTCXO
- 3.3V Operation
- LVC MOS Output
- Clipped Sinewave Output
- Frequency Stability:
  - TV50x/TV60x-Series +/-0.28ppm
  - TV51x/TV61x-Series +/-0.50ppm
  - TV52x/TV62x-Series +/-1.00ppm
- Temperature Range:
  - TV5xx-Series 0 to 70°C
  - TV6xx-Series -40 to 85°C
- Low Jitter < 1pS RMS
- Surface Mount Package
- Tape and Reel Packing
- RoHS Compliant / Lead Free
- Recommended for New Designs
- Matches Vectron's VTC1-Series Footprint

## LVC MOS Test Circuit

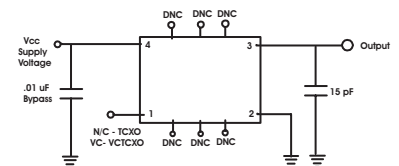

## Clipped Sinewave Test Circuit

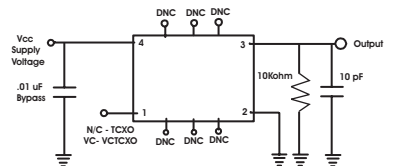

US Headquarters:  
630-851-4722  
European Headquarters:  
+353-61-472221

Bulletin	Tx215
Page	2 of 4
Revision	01
Date	25 Aug 2008

## Electrical Specifications for all Models

### Operating Specifications

Table 9.0

Parameter	Minimum	Nominal	Maximum	Units	Notes
TCXO Frequency Calibration @ 25°C	-1.00	-	1.00	ppm	1
Supply Voltage Variation. (Vcc±5%)	-0.2	-	0.2	ppm	
Load Coefficient, ±5%	-0.2	-	0.2	ppm	
Static Temperature Hysteresis	-0.4	-	0.4	ppm	2
Total Frequency Tolerance	-4.60	-	4.60	ppm	3
Supply Voltage (Vcc)	3.135	3.3	3.465	Vdc	4
Supply Current (Icc)	-	6	10	mA	
Period Jitter	-	3	5	ps rms	
Integrated Phase Jitter (BW=12kHz to 20MHz)	-	0.3	1.0	ps rms	
SSB Phase Noise at 10Hz offset	-	-80	-70	dBc/Hz	
SSB Phase Noise at 100Hz offset	-	-110	-100	dBc/Hz	
SSB Phase Noise at 1KHz offset	-	-135	-130	dBc/Hz	
SSB Phase Noise at >10KHz offset	-	-150	-145	dBc/Hz	
SSB Phase Noise at >100KHz offset	-	-150	-150	dBc/Hz	
Start Up Time	-	-	10	ms	

### Input Characteristics For Voltage Control (Pad 1)

Table 10.0

Parameter	Minimum	Nominal	Maximum	Units	Notes
Control Voltage Range (Vcc = 3.3V) (Vc)	0.3	1.65	3.0	Vdc	
Frequency Tuning	±10	-	-	ppm	5
Linearity	±5	-	-	%	
Slope	Positive				

### LVC MOS Output Characteristics

Table 11.0

Parameter	Minimum	Nominal	Maximum	Units	Notes
LOAD	-	-	15	pF	
Voltage (High) (Voh)	90%Vcc	-	-	Vdc	
Voltage (Low) (Vol)	-	-	10%Vcc	Vdc	
Current (High) (Ioh)	-4	-	-	mA	
Current (Low) (Iol)	-	-	4	mA	
Duty Cycle at 50% of Vcc	45	50	55	%	
Rise / Fall Time 10% to 90%	-	-	8	ns	

### Clipped Sinewave Output Characteristics

Table 12.0

Parameter	Minimum	Nominal	Maximum	Units	Notes
Load	-	-	-	-	6
Output Load Resistance	-	10K	-	Ohms	
Output Load Capacitance	-	10	-	pF	
Output Voltage (<= 40 MHz)	1.00	-	-	V pk-pk	
Output Voltage (> 40 MHz)	0.80	-	-	V pk-pk	

#### Notes:

- 1) TCXO: Initial calibration @ 25°C. Specifications at time of shipment after 48 hours of operation.
- 2) Frequency change after reciprocal temperature ramped over the operating range. Frequency measured before and after at 25°C.
- 3) Inclusive of calibration @ 25°C, frequency vs. change in temperature, change in supply voltage (±5%), load change (±5%), reflow soldering process and 20 years aging.
- 4) For best in application performance, careful selection of an external power source is critical. Select an external regulator that meets or exceeds to following specifications regarding voltage regulation tolerance, initial accuracy, temperature coefficient, voltage noise, and low voltage noise density.  
**Factory Test Conditions:** Initial Accuracy ±2mv, Noise (0.1Hz to 10 KHz) 15uV p-p, Voltage Noise Density = 50nV/sqrt Hz, Temperature Coefficient < 5ppm°C.
- 5) Additional pull ranges are available; please contact the factory for additional information.
- 6) Output is AC coupled.

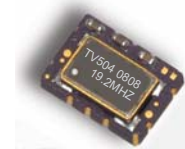

### Features

TCXO  
VCTCXO  
3.3V Operation  
LVC MOS Output  
Clipped Sinewave Output  
Frequency Stability:  
TV50x/TV60xSeries +/-0.28ppm  
TV51x/TV61x-Series +/-0.50ppm  
TV52x/TV62x-Series +/-1.00ppm  
Temperature Range:  
TV5xx-Series 0 to 70°C  
TV6xx-Series -40 to 85°C  
Low Jitter < 1ps RMS  
Surface Mount Package  
Tape and Reel Packing  
RoHS Compliant / Lead Free  
Recommended for New Designs  
Matches Vectron's VTC1-Series  
Footprint

### LVC MOS Test Circuit

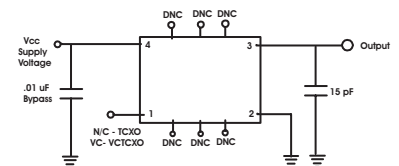

### Clipped Sinewave Test Circuit

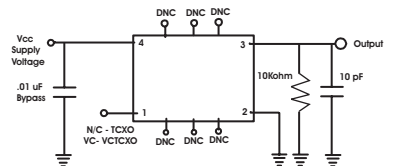

US Headquarters:  
630-851-4722  
European Headquarters:  
+353-61-472221

Bulletin	Tx215
Page	3 of 4
Revision	01
Date	25 Aug 2008

## Design Recommendations

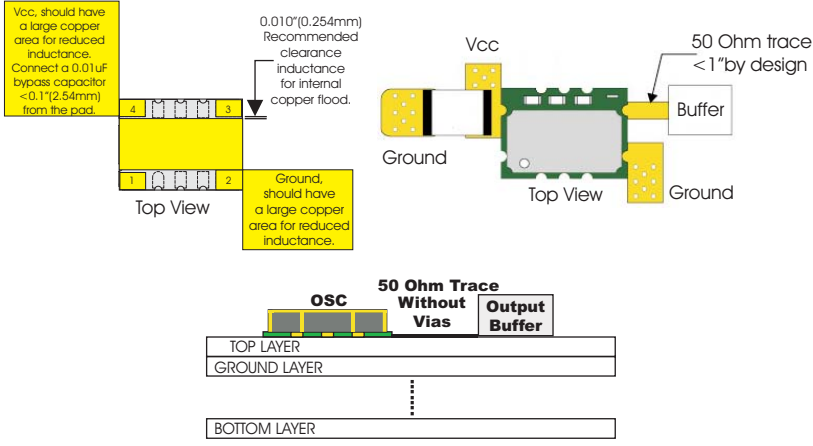

## Typical Phase Noise

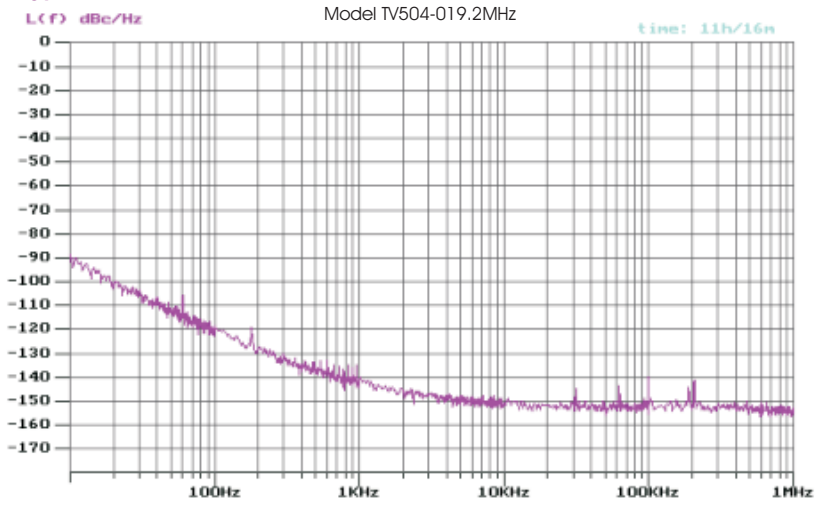

## Tape and Reel Specifications

Meets EIA-481A and EIJ-1009B  
2000 Pieces/Reel Maximum.

4-PAD Ceramic Package  
0.197x0.295 (5.0x7.0mm)  
Standard Orientation

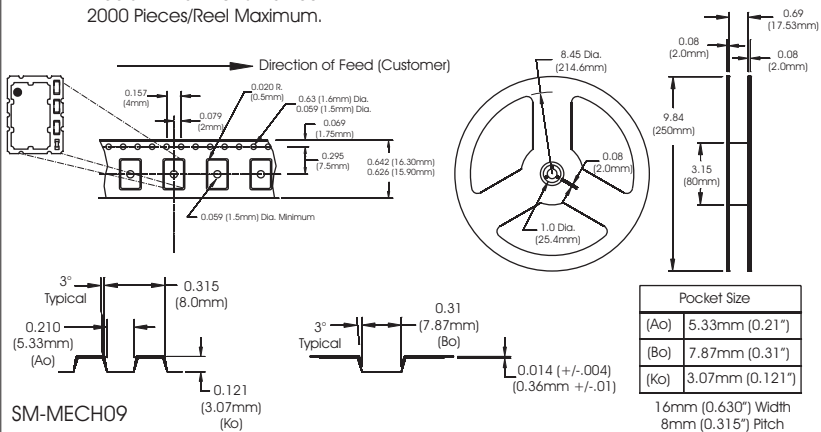

## Package Characteristics

Table 13.0

Package	Ceramic Surface Mount Package.
---------	--------------------------------

## Environmental Characteristics

Table 14.0

Vibration:	Vibration per Mil Std 883E Method 2007.3 Test Condition A
Shock:	Mechanical Shock per Mil Std 883E Method 2002.4 Test Condition B.
Soldering:	SMD product suitable for Convection Reflow soldering. Peak temperature 260°C. Maximum time above 220°C, 60 seconds.
Solderability:	Solderability per Mil Std 883E Method 2003

## Suggested Pad Layout

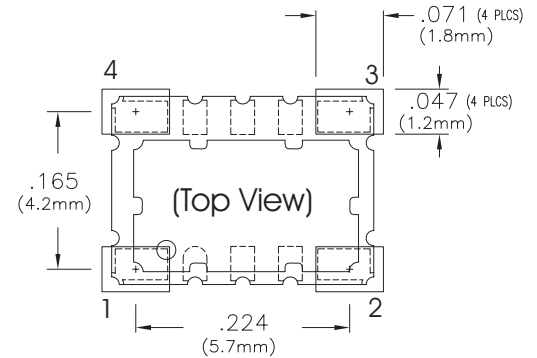

## Solder Profile

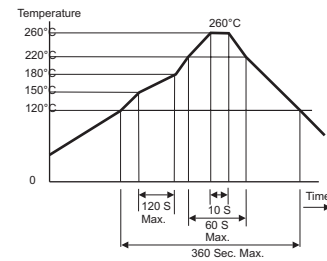

## LVC MOS Output Waveform

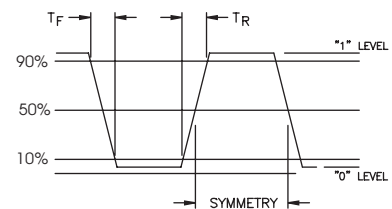

## Clipped Sinewave Output Waveform

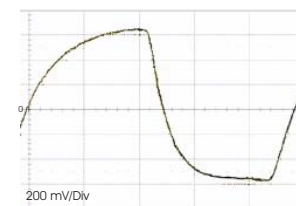

US Headquarters:  
630-851-4722

European Headquarters:  
+ 353-61-472211

Bulletin	Tx215
Page	4 of 4
Revision	01
Date	25 Aug 2008