

Plug-in D-type Optical Fiber Connectors for Terminal Equipment Mounting

HRPI Series

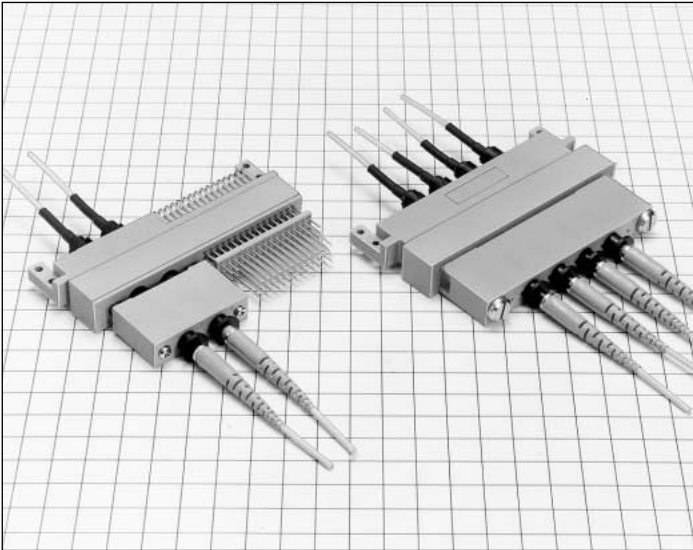

Connector Mounting Condition Diagram

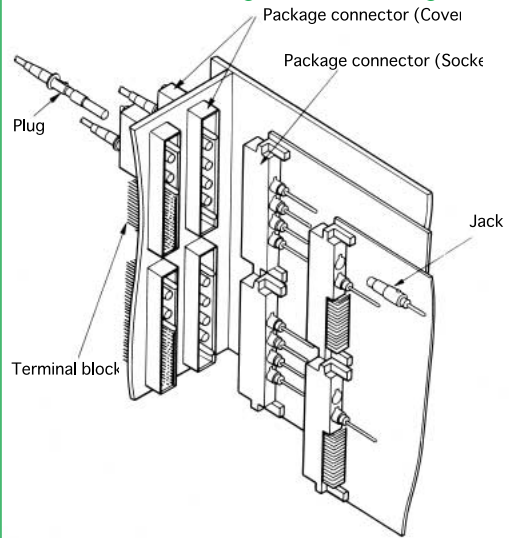

■ Features

1. Compliant with D-type Optical Fiber Connector Standards

These connectors are compliant with NTT D-type optical fiber connector standards.
JIS C 5980 (CF11-type optical fiber connectors)

2. Zirconia Ferrules

Zirconia ferrules that are the same shape as those of the HSC Series are used.

3. Housing

Optical terminals and coaxial terminals can be used in the same connector housing.

4. Removal of Optical Terminals

Removal from the optical terminal housing is performed with a slider operation from the back side in the case of the plug side, and by using a special tool from the front in the case of the jack side.

■ Applications

Optical terminal equipment, optical relay racks, measuring instruments, etc.

Function Diagram (4-Fiber Housing)

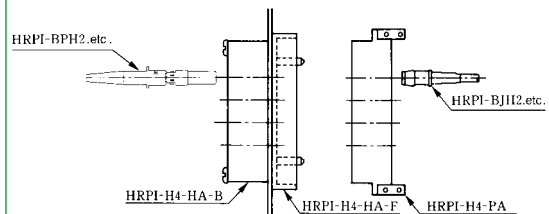

Function Diagram (Duplex Housing)

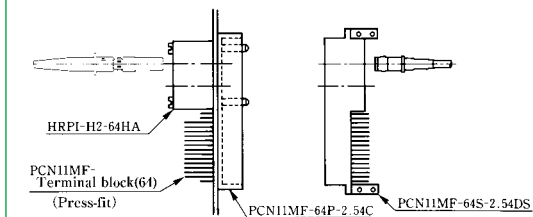

Product Standards

Rating	Operating temperature range	-25°C~70°C	Storage temperature range	-25°C~70°C
--------	-----------------------------	------------	---------------------------	------------

Item		Test Method (JIS C 5961)	Standard
Optical Performance	Insertion loss	(SM) 1,300nm wavelength (LD)	0.5 dB or less (PC, AdPC)
		(GI) 1,300nm wavelength (LED)	0.3 dB or less (PC, AdPC)
	Reflection attenuation	(SM) 1,300nm wavelength (LD)	22 dB or greater (PC) 40 dB (AdPC)
		(GI)	22 dB or greater (PC)
Mechanical Performance	Split sleeve holding force of the adapter	$\phi 2.499 \pm 0.0005$ mm zirconia gauge	Phosphor bronze 2 to 5.9 N Zirconia 2 to 3.9 N
	Cable clamp strength (Pulling in direction of axis)	98 N of pulling force between connector and cable for one minute (Bellcore TA-TSY-00326)	① Insertion loss fluctuation after test: 0.2dB or less ② No irregularity in clamp section or cable
	Repetitive operation	1,000 times	① Insertion loss fluctuation after test: 0.2 dB or less ② No damage, cracks, or part looseness
	Vibration resistance	Vibration range of 10 to 55 Hz Test in 3 directions, 2 hours each	
	Shock resistance	Acceleration of 981 m/s ² , in 3 directions, 10 times each (Total of 30 times)	
Environmental performance	Humidity resistance (Temperature and humidity cycle)	Temperature -10°C to 65°C, humidity 90 to 96% 10 cycles	No conspicuous corrosion
	Temperature cycle	Temperature -40 to 75°C 42 cycles (Bellcore TA-NWT-00326)	
	Heat resistance	Leave for 960 hours at a temperature of 85°C	
	Cold resistance	Leave for 960 hours at a temperature of -25°C	
	Salt fog	Left in a 5% concentration of salt fog for 48 hours	

Materials

Part name	Material
Plug housing	Polybutylene terephthalate
Coil spring	Steel
Ferrule	Zirconia
Jack housing	Polybutylene terephthalate
Split sleeve	Copper alloy or zirconia
Housing	Polybutylene terephthalate

Types

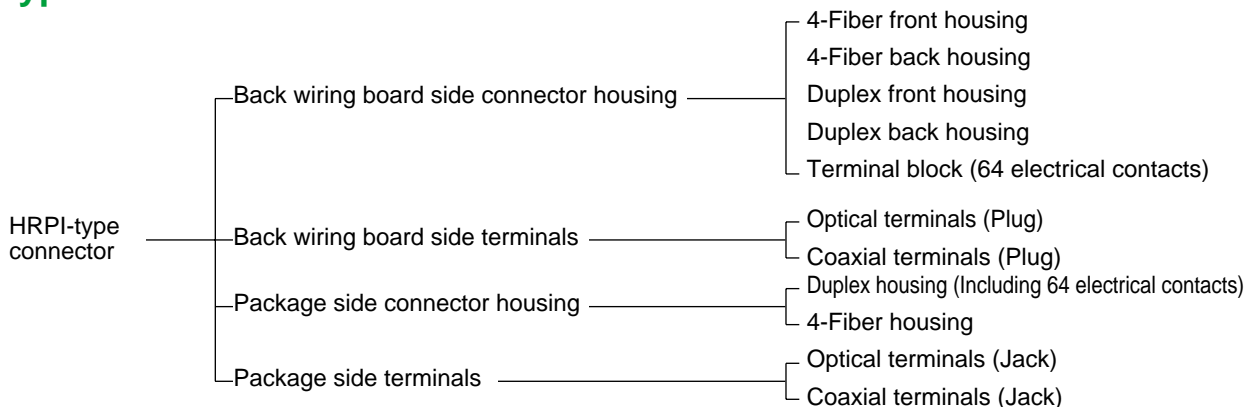

HRPI Connector Function Diagram

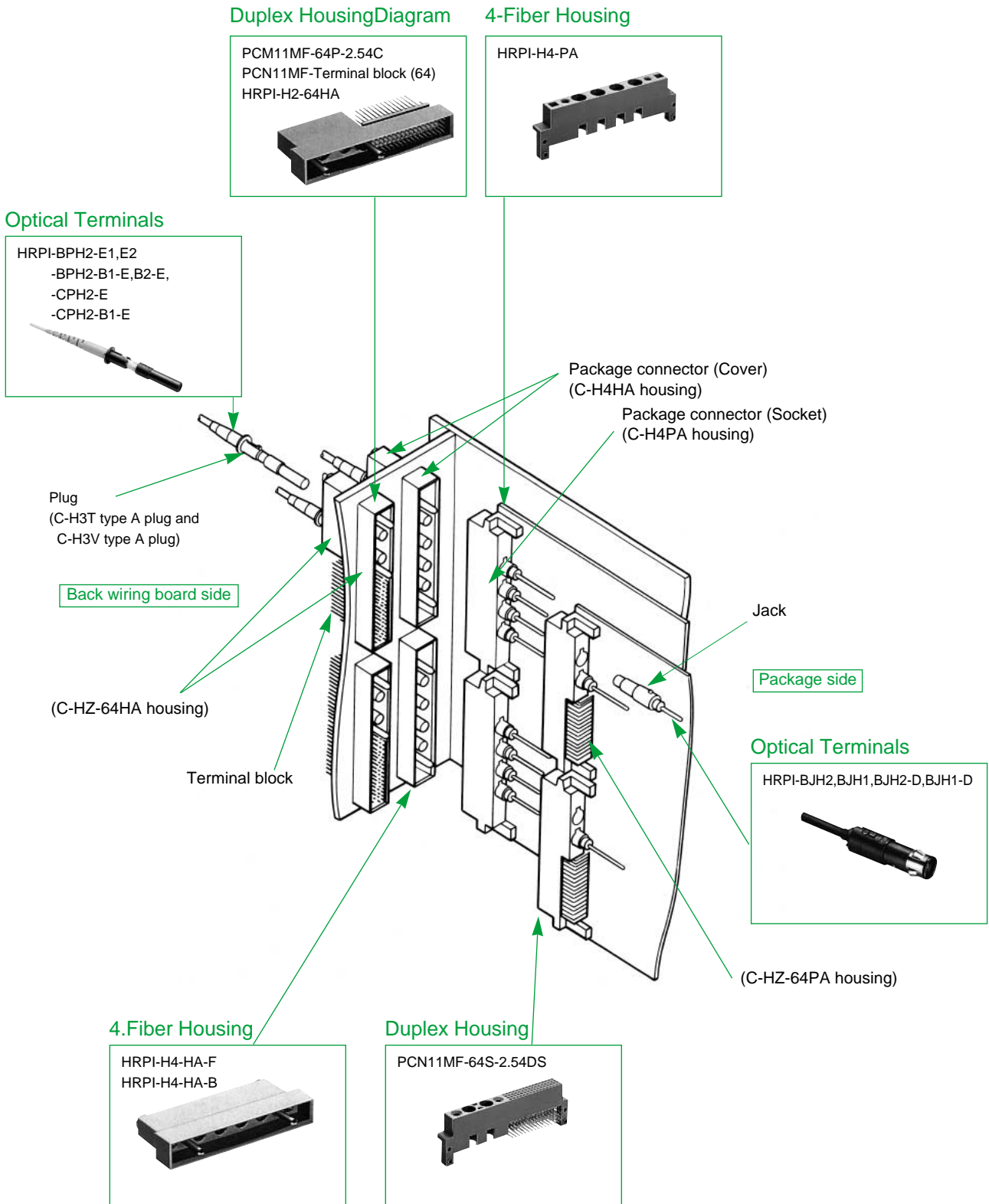

※ NTT product names are in parentheses ()

■Back Wiring Board Side Connector Housing

●4-Fiber Front Housing

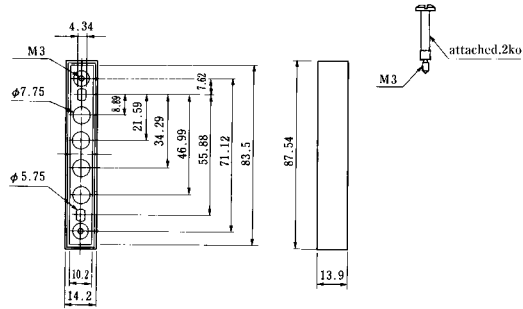

HRS No.	Product Number	Suitable Optical Terminals
CL707-0001-5	HRPI-H4-HA-F	HRPI-BPH2-E1, etc.

(NOTE)The recommended clamp torque to be 58.8 N

●4-Fiber Back Housing

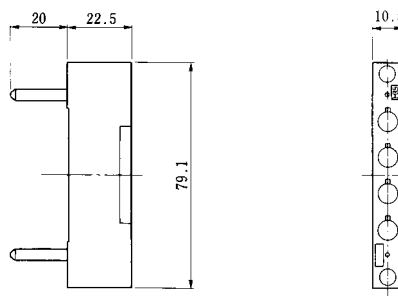

HRS No.	Product Number	Suitable Optical Terminals
CL707-0002-8	HRPI-H4-HA-B	HRPI-BPH2-E1, etc.

●Duplex Front Housing

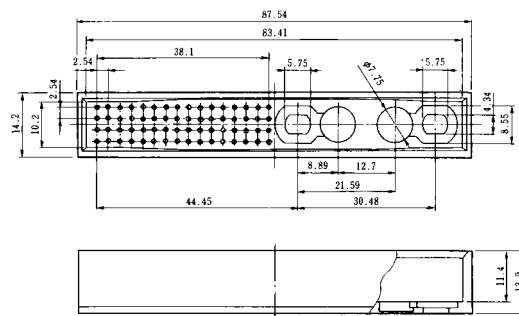

HRS No.	Product Number	Suitable Optical Terminals
CL583-1230-4	PCN11MF-64P-2.54C	HRPI-BPH2-E1, etc.

●Duplex Back Housing

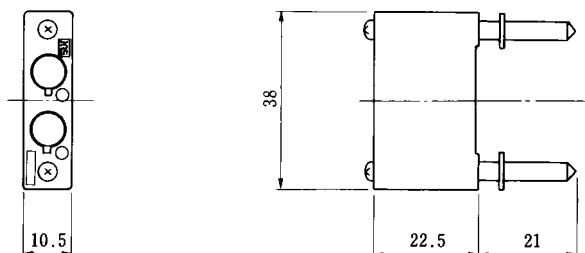

HRS No.	Product Number	Suitable Optical Terminals
CL707-0004-3	HRPI-H2-64HA	HRPI-BPH2-E1, etc.

Terminal Block

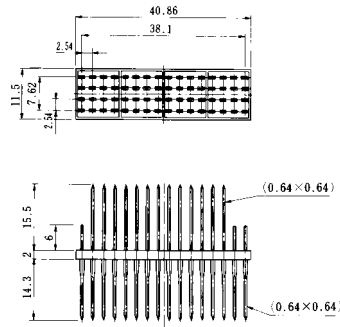
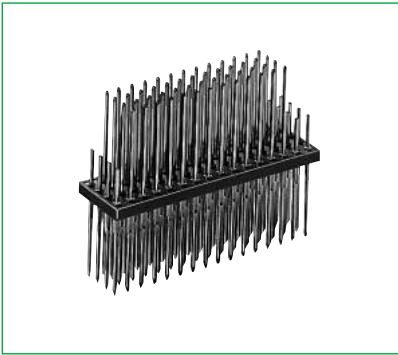

HRS No.	Product Number
CL583-1229-5	PCN11MF-Terminal Block (64)

Reference Mounting Dimensions Diagram

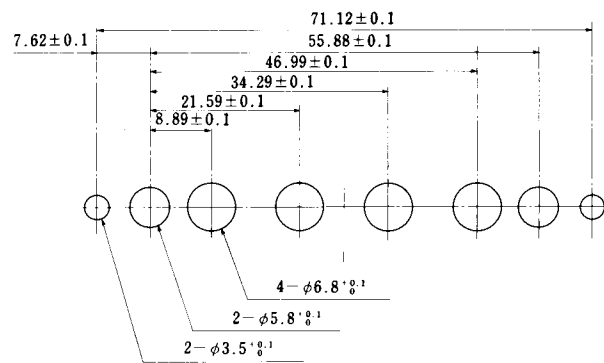

●HRPI-H4-HA-F

●HRPI-H4-HA-B

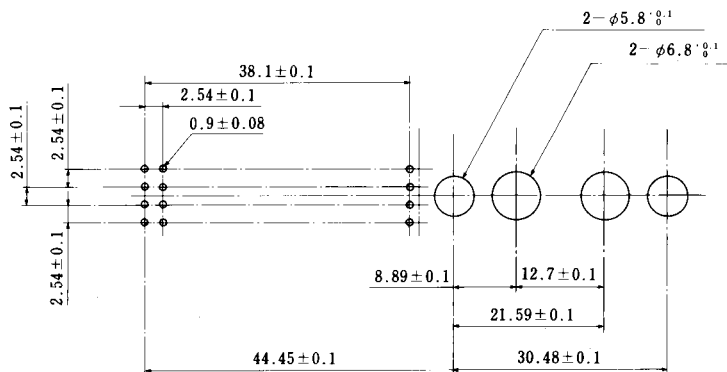

●PCN11MF-64P-2.54C

●PCN11MF-Terminal Block (64)

●HRPI-H2-64HA

Note : Recommended panel thickness to be 2.4mm

■ Back Wiring Board Side Plastic Type Optical Terminals

● Plug for Multimode Fiber

Reinforced Cable Clamp

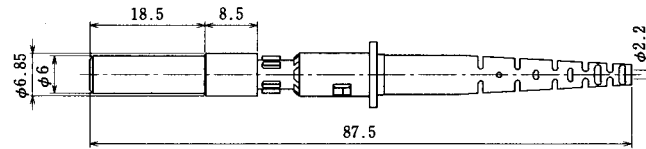

HRS No.	Product Number	Suitable Fiber	Suitable Cable Diameter	Color of Boot	Polishing Specification
CL707-0041-0	HRPI-CPH2-B1-E	GI-50/125	φ2mm	Blue	PC

● Plug for Single Mode Fiber

Reinforced Cable Clamp

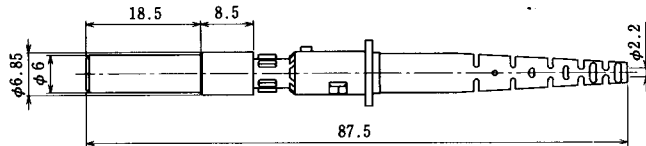

HRS No.	Product Number	Suitable Fiber	Suitable Cable Diameter	Color of Boot	Polishing Specification
CL707-0038-5	HRPI-BPH2-B1-E	SM-9.5/125	φ2mm	Blue	PC
CL707-0039-8	HRPI-BPH2-B2-E	SM-9.5/125	φ2mm	Light purple	AdPC

■ Package Side Connector Housing

● 4-Fiber Housing

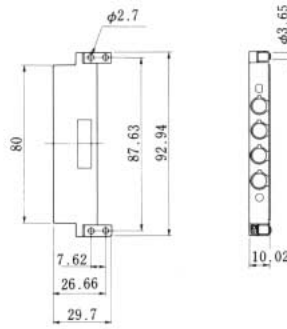
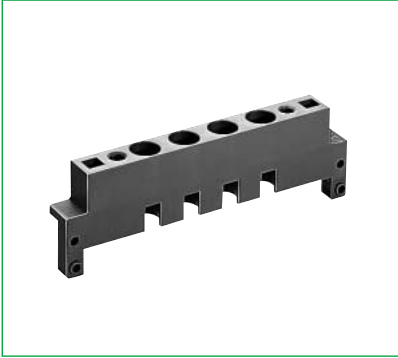

HRS No.	Product Number	Suitable Optical Terminals
CL707-0003-0	HRPI-H4-PA	HRPI-BJH2

● Duplex Housing

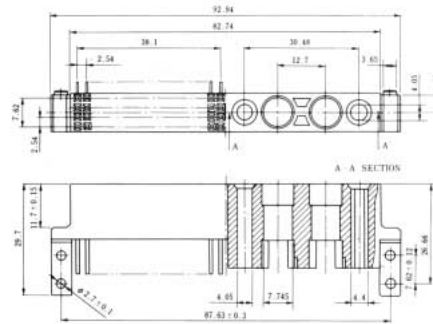
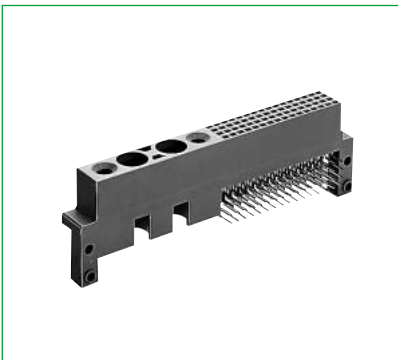

HRS No.	Product Number	Suitable Optical Terminals
CL583-1238-6	PCN11MF-64S-2.54DS	HRPI-BJH2

◆ Reference Mounting Dimensions Diagram

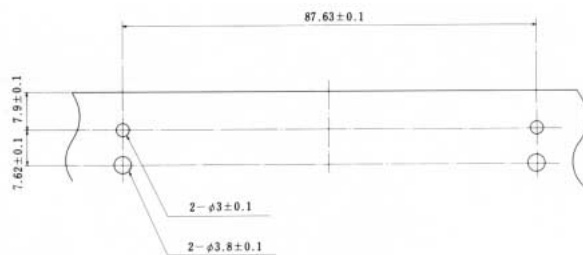

● HRPI-H4-PA

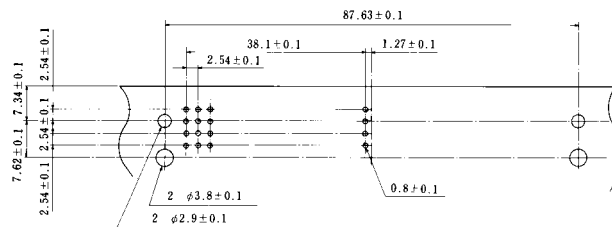

● PCN11MF-64S-2.54DS

Note : Recommended panel thickness to be 2.4mm

■Package Side Terminals

●Optical Terminals (Jack)

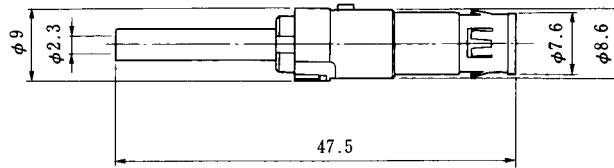

HRS No.	Product Number	Suitable Fiber	Suitable Cable	Split Sleeve Specification
CL707-0007-1	HRPI-BJH2	SM-9.5/125,GI-50/125	φ2mm	Copper alloy
CL707-0016-2	HRPI-BJH2-D	SM-9.5/125,GI-50/125	φ2mm	Zirconia

●Optical Terminals for Cable (Jack)

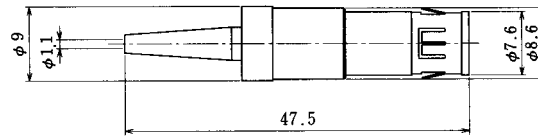

HRS No.	Product Number	Suitable Fiber	Suitable Cable	Split Sleeve Specification
CL707-0042-2	HRPI-BJH1	SM-9.5/125,GI-50/125	φ0.9mm	Copper alloy
CL707-0029-4	HRPI-BJH1-D	SM-9.5/125,GI-50/125	φ0.9mm	Zirconia

■Ferrules

Please use a zirconia ferrule that suits to the SC type optical fiber connector. (See page 28.)

■Tools

●Crimping Tool



HRS No.	Product Number	Suitable Connectors	Notes
CL704-0287-0	HSC-T3	HRPI-BPH2 HRPI-CPH2	Same as the SC tool

<Usage>

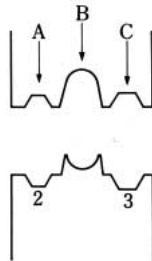

- (1)Area "A" for 2mm dia · cable jacket crimping (indicated at "2")
 Area "C" for 3mm dia · cable jacket crimping (indicated at "3")
 (2)Area "B" for Kevlar crimping

●Terminal Extraction Tool



HRS No.	Product Number	Suitable Connectors
CL350-0104-7	PO73-T-HPJRMV	HRPI-BJH2,PO73-J-2.5CV

Usage : Used when removing the HRPI-BJH2 from the package side housing. (See diagram below.)

1. Insert the PO73-T-HPJRMV, from which piston ② has already been retracted, into the package side housing (into which HRPI-BJH2 is mounted).

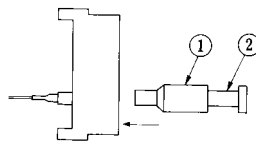

2. Press piston ② while portion ① remains pressed into the package side housing.

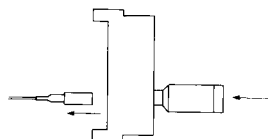

■ Connectors for Measurement Applications



Usage : Attach the connector to a measuring instrument such as a sensor and use for making measurements such as optical power. (See diagram below.)

● For HRPI-BPH2-E, CPH2-E and other measurements

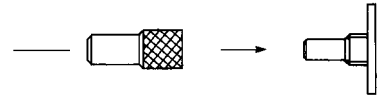

● For HRPI-BJH2

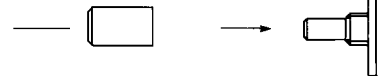

HRS No.	Product Number	Notes
—	HRPI-R-L	For main unit with lens attached, and optical power measurements
CL707-0043-5	HRPI-R-A	Plug and jack attachment



Usage : Used in performance measurements of wired plug-in connectors. (See diagram below.)

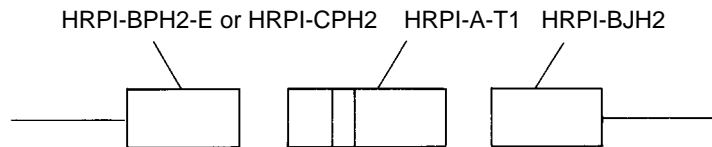

HRS No.	Product Number	Notes
CL707-0008-4	HRPI-A-T1	For loss measurements

NOTE: A special terminal extraction tool, PO73-T-HPJRMV (CL350-0104-7) is required when removing HRPI-BJH2 from HRPI-A-T1.



Usage : Used in the adjustment of the offset direction of the wired plug-in connector. (See diagram below.)

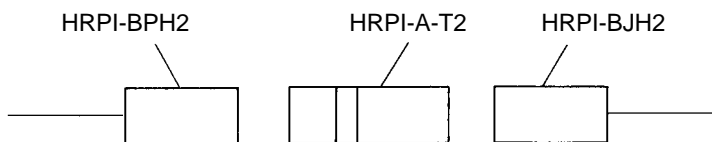

HRS No.	Product Number	Notes
CL707-0009-7	HRPI-A-T2	For adjustment of the offset direction

NOTE: A special terminal extraction tool, PO73-T-HPJRMV (CL350-0104-7) is required when removing HRPI-BJH2 from HRPI-A-T2.