

# G3VM-□L/□FL/□GL

MOS FET Relays Current-limiting Type

## MOS FET Relays that protect themselves from overcurrents with a current-limiting protection function



- Package: DIP 4-pin, DIP 8-pin or SOP 4-pin
- Contact form: 1a (SPST-NO) or 2a (DPST-NO)
- Load voltage: 350 V
- Current limit: 150 to 300 mA

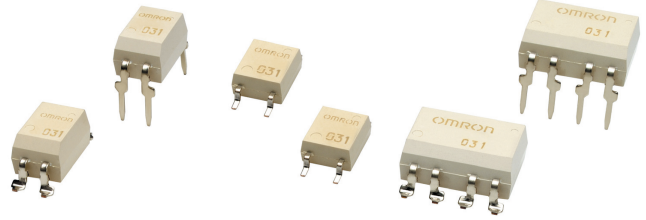

Note: The actual product is marked differently from the image shown here.

### Application Examples

- Communication equipment
- Industrial equipment
- Test & Measurement equipment

### Package

(Unit : mm, Average)

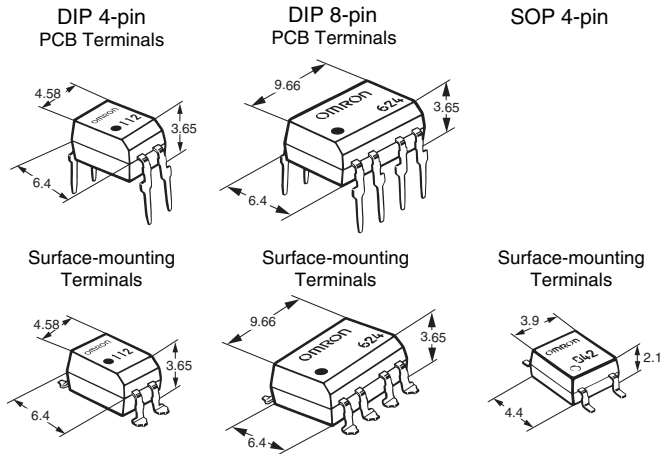

Note: The actual product is marked differently from the image shown here.

### Model Number Legend

G3VM-□□□□  
1 2 3 4

- |   |   |
|---|---|
| 1. Load Voltage<br>35 : 350 V                               | 2. Contact form<br>1 : 1a (SPST-NO)             |
| 3. Package<br>G : SOP 4-pin with surface-mounting terminals | 4. Additional functions<br>L : Current limiting |

Note: The model number legend for the G3VM-2L/2FL/WL/WFL is different from the above legend.

### Ordering Information

Package	Contact form	Load voltage (peak value) *	Continuous load current (peak value) *	Stick packaging		Tape packaging		
				Model		Minimum package quantity	Model	Minimum package quantity
				PCB Terminals	Surface-mounting Terminals		Surface-mounting Terminals	
DIP4	1a (SPST-NO)	350 V	120 mA	G3VM-2L	G3VM-2FL	100 pcs.	G3VM-2FL(TR)	1,500 pcs.
DIP8	2a (DPST-NO)			G3VM-WL	G3VM-WFL		50 pcs.	
SOP4	1a (SPST-NO)			-	G3VM-351GL	100 pcs.	G3VM-351GL(TR)	2,500 pcs.

\* The AC peak and DC value are given for the load voltage and continuous load current.

Note: To order tape packaging for Relays with surface-mounting terminals, add "(TR)" to the end of the model number.

### ■ Absolute Maximum Ratings (Ta = 25°C)

Item		Symbol	G3VM-2L G3VM-2FL	G3VM-WL G3VM-WFL	G3VM-351GL	Unit	Measurement conditions
Input	LED forward current	IF	50			mA	
	Repetitive peak LED forward current	IFP	1			A	100 μs pulses, 100 pps
	LED forward current reduction rate	ΔIF/°C	-0.5			mA/°C	Ta ≥ 25°C
	LED reverse voltage	VR	6		5	V	
Connection temperature		TJ	125			°C	
Output	Load voltage (AC peak/DC)	VOFF	350			V	
	Continuous load current (AC peak/DC)	Io	120			mA	
	ON current reduction rate	ΔIo/°C	-1.2			mA/°C	Ta ≥ 25°C
	Connection temperature	TJ	125			°C	
Dielectric strength between I/O *		VI-O	2500		1500	Vrms	AC for 1 min
Ambient operating temperature		Ta	-40 to +85			°C	With no icing or condensation
Ambient storage temperature		Tstg	-55 to +125			°C	
Soldering temperature		-	260			°C	10 s

\* The dielectric strength between the input and output was checked by applying voltage between all pins as a group on the LED side and all pins as a group on the light-receiving side.

## Electrical Characteristics (Ta = 25°C)

Item		Symbol	G3VM-2L G3VM-2FL	G3VM-WL G3VM-WFL	G3VM-351GL	Unit	Measurement conditions
Input	LED forward voltage	VF	Minimum	1.0		V	If=10 mA
			Typical	1.15			
			Maximum	1.3			
	Reverse current	IR	Maximum	10		μA	G3VM-2L/2FL/WL/WFL : VR=6 V G3VM-351GL : VR=5 V
	Capacitance between terminals	CT	Typical	30		pF	V=0, f=1 MHz
	Trigger LED forward current	IFT	Typical	1		mA	Io=120 mA
Release LED forward current	Maximum		3				
Output	Maximum resistance with output ON	RON	Typical	22	15	Ω	If=5 mA, Io=120 mA
	Current leakage when the relay is open		Maximum	35			
	Capacitance between terminals	COFF	Typical	40	70	pF	V=0, f=1 MHz
	Limit current	ILIM	Minimum	150		mA	If=5 mA, VDD=5 V, t=5 ms
	Capacitance between I/O terminals		Maximum	300			
	Insulation resistance between I/O terminals	RI-O	Minimum	1000		MΩ	Vi-o=500 VDC, RoH≤60%
Turn-ON time	Typical		-	0.3			
Turn-OFF time	TOFF	Typical	-	0.1	ms	If=5 mA, RL=200 Ω, VDD=2 V *	
		Maximum	1.0				

\* Turn-ON and Turn-OFF Times

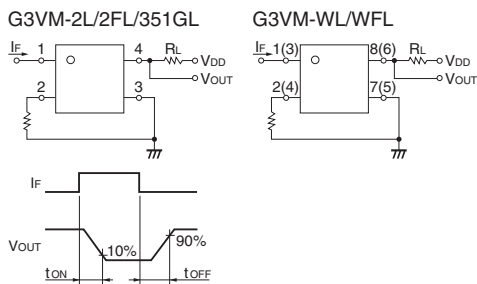

## Recommended Operating Conditions

For usage with high reliability, Recommended Operation Conditions is a measure that takes into account the derating of Absolute Maximum Ratings and Electrical Characteristics.

Each item on this list is an independent condition, so it is not simultaneously satisfy several conditions.

Item	Symbol		G3VM-2L G3VM-2FL	G3VM-WL G3VM-WFL	G3VM-351GL	Unit
Load voltage (AC peak/DC)	VDD	Maximum	280			V
Operating LED forward current	IF	Minimum	5			mA
		Typical	7.5			
		Maximum	25			
Continuous load current (AC peak/DC)	Io	Maximum	100			A
Ambient operating temperature	Ta	Minimum	-20			°C
		Maximum	65			

## Spacing and Insulation

Item	Minimum		Unit
	G3VM-□L/□FL	G3VM-□GL	
Creepage distances	7.0	2.5	mm
Clearance distances	7.0	2.5	
Internal isolation thickness	0.4	0.1	

## Engineering Data

### LED forward current vs. Ambient temperature

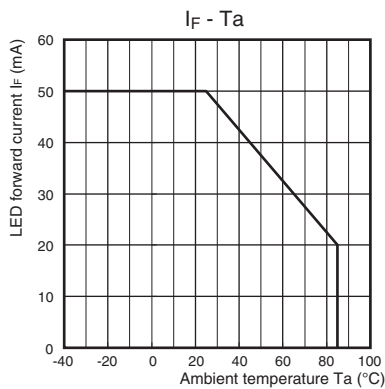

### Continuous load current vs. Ambient temperature

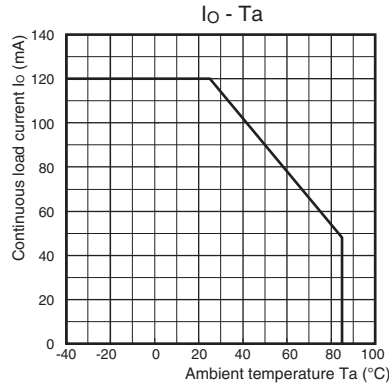

### LED forward current vs. LED forward voltage

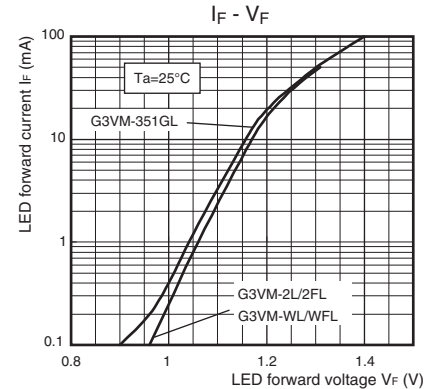

### Continuous load current vs. On-state voltage

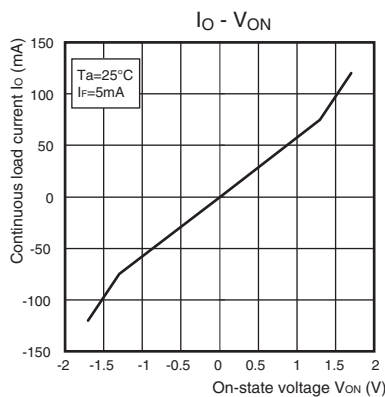

### On-state resistance vs. Ambient temperature

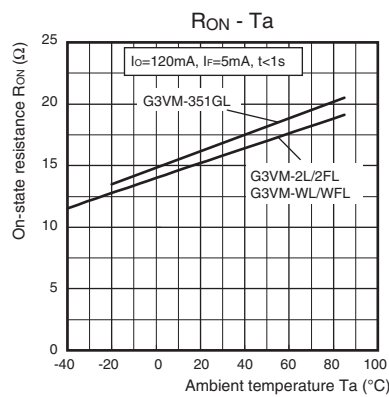

### Trigger LED forward current vs. Ambient temperature

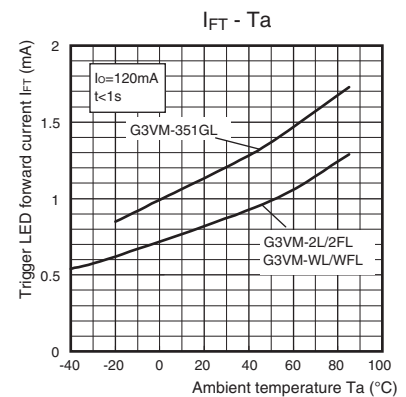

### Turn ON, Turn OFF time vs. LED forward current

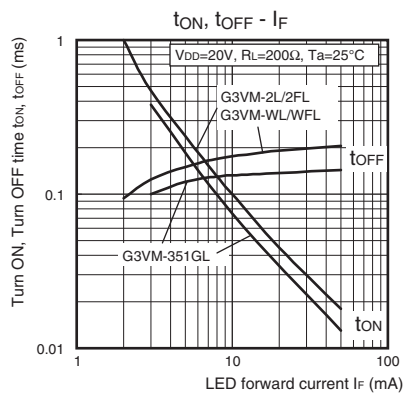

### Turn ON, Turn OFF time vs. Ambient temperature

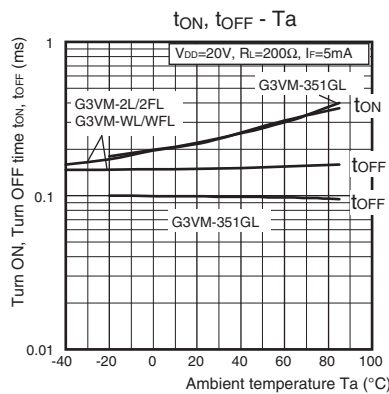

### Current leakage vs. Ambient temperature

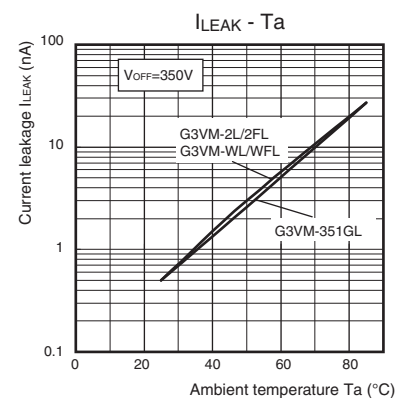

## ■ Appearance / Terminal Arrangement / Internal Connections

### ● Appearance

#### DIP (Dual Inline Package)

DIP 4-pin

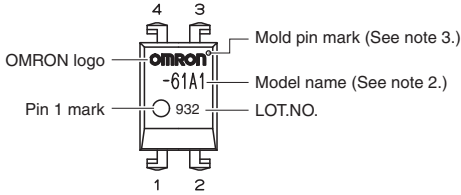

### ● Terminal Arrangement/Internal Connections (Top View)

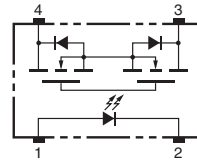

DIP 8-pin

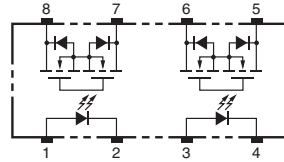
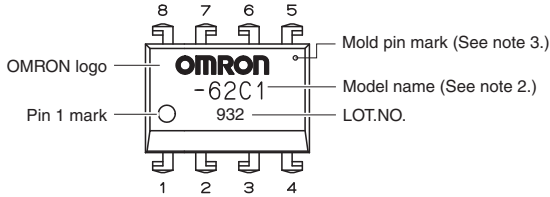

#### SOP (Small Outline Package)

SOP 4-pin

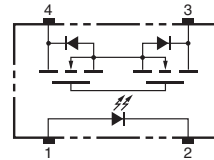
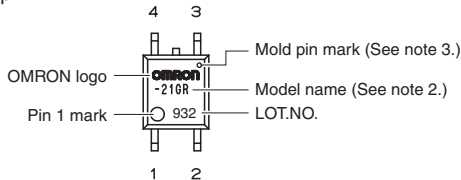

- Note 1:** The actual product is marked differently from the image shown here.
- Note 2:** "G3VM" does not appear in the model number on the Relay.
- Note 3:** The indentation in the corner diagonally opposite from the pin 1 mark is from a pin on the mold.

## ■ Dimensions (Unit: mm)

### G3VM-2L

#### PCB Terminals

Weight: 0.4 g

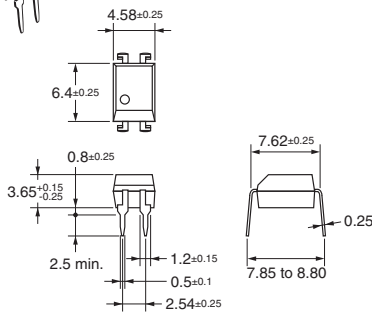

### G3VM-2FL

#### Surface-mounting Terminals

Weight: 0.4 g

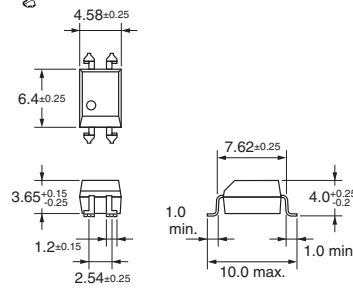

#### PCB Dimensions (BOTTOM VIEW)

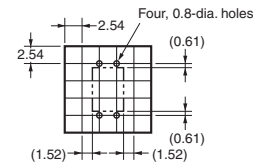

#### Actual Mounting Pad Dimensions

(Recommended Value, TOP VIEW)

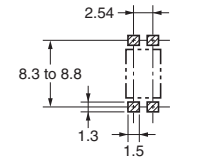

**Note:** The actual product is marked differently from the image shown here.

### G3VM-WL

#### PCB Terminals

Weight: 0.54 g

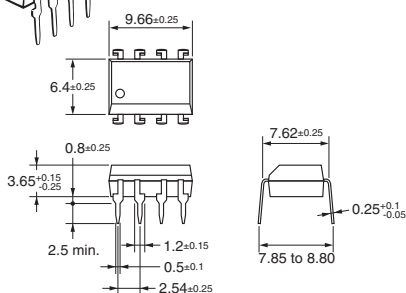

### G3VM-WFL

#### Surface-mounting Terminals

Weight: 0.54 g

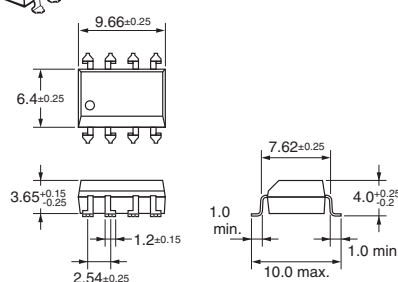

#### PCB Dimensions (BOTTOM VIEW)

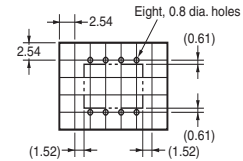

#### Actual Mounting Pad Dimensions

(Recommended Value, TOP VIEW)

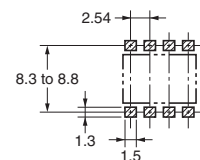

**Note:** The actual product is marked differently from the image shown here.

## ■Dimensions (Unit: mm)

G3VM-351GL

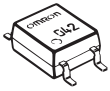

### Surface-mounting Terminals

Weight: 0.1 g

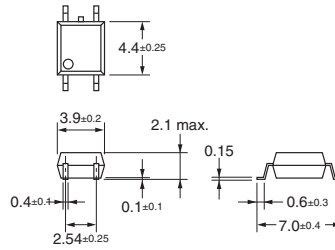

### Actual Mounting Pad Dimensions

(Recommended Value, TOP VIEW)

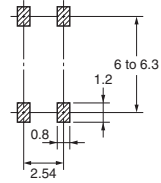

**Note:** The actual product is marked differently from the image shown here.

## ■Approved Standards

UL recognized 

Model	Approved Standards	Contact form	File No.
G3VM-2L G3VM-2FL	UL (recognized)	1a (SPST-NO)	E80555
G3VM-WL G3VM-WFL		2a (DPST-NO)	

## ■Safety Precautions

- Refer to the *Common Precautions for All MOS FET Relays* for precautions that apply to all MOS FET Relays.

DIP

G3VM-□L/□FL/□GL

Please check each region's Terms & Conditions by region website.

## OMRON Corporation

Device & Module Solutions Company

### Regional Contact

#### Americas

<https://components.omron.com/us>

#### Asia-Pacific

<https://components.omron.com/ap>

#### Korea

<https://components.omron.com/kr>

#### Europe

<https://components.omron.com/eu>

#### China

<https://components.omron.com.cn>

#### Japan

<https://components.omron.com/jp>