



32K x 8 Power-Switched and Reprogrammable PROM

Features

- CMOS for optimum speed/power
- Windowed for reprogrammability
- High speed
 - 25 ns (commercial)
 - 35 ns (military)
- Low power
 - 275 mW (commercial)
 - 330 mW (military)
- Super low standby power
 - Less than 85 mW when deselected
- EPROM technology 100% programmable
- Slim 300-mil package
- Direct replacement for bipolar PROMs

- Capable of withstanding >4001V static discharge

Functional Description

The CY7C271A is a high-performance 32,768-word by 8-bit CMOS PROM. When disabled (CE HIGH), the 7C271A automatically powers down into a low-power stand-by mode. The CY7C271A is packaged in the 300-mil slim package and is available in a cerDIP package equipped with an erasure window to provide for reprogrammability. When exposed to UV light, the PROM is erased and can be reprogrammed. The memory cells utilize proven EPROM floating gate technology and byte-wide intelligent programming algorithms.

The CY7C271A offers the advantages of lower power, superior performance, and

programming yield. The EPROM cell requires only 12.5V for the super voltage, and low current requirements allow for gang programming. The EPROM cells allow each memory location to be tested 100% because each location is written into, erased, and repeatedly exercised prior to encapsulation. Each PROM is also tested for AC performance to guarantee that after customer programming, the product will meet DC and AC specification limits.

Reading the 7C271A is accomplished by placing active LOW signals on CS₁ and CE, and an active HIGH on CS₂. The contents of the memory location addressed by the address lines (A₀ - A₁₄) will become available on the output lines (O₀ - O₇).

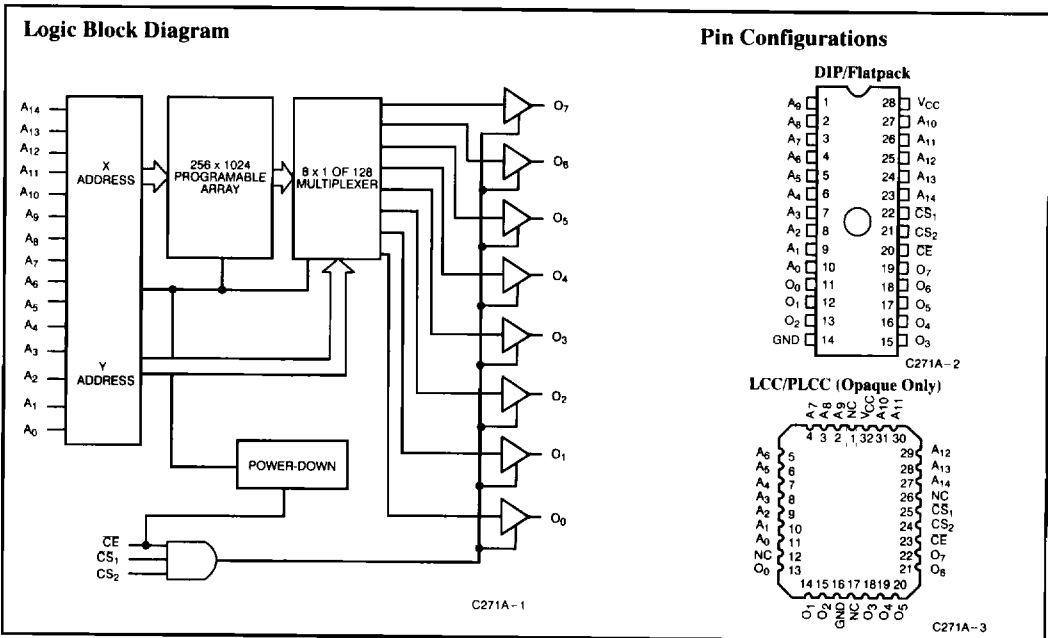

Selection Guide

	7C271A-25	7C271A-30	7C271A-35	7C271A-45	7C271A-55
Maximum Access Time (ns)	25	30	35	45	55
Maximum Operating Current (mA)	Com'l	75	50	50	50
	Military		85	60	60
Standby Current (mA)	Com'l	15	15	15	15
	Military			25	25

Maximum Ratings

(Above which the useful life may be impaired. For user guidelines, not tested.)

Storage Temperature	-65°C to +150°C
Ambient Temperature with Power Applied	-55°C to +125°C
Supply Voltage to Ground Potential	-0.5V to +7.0V
DC Voltage Applied to Outputs in High Z State	-0.5V to +7.0V
DC Input Voltage	-3.0V to +7.0V
DC Program Voltage	13.0V
Static Discharge Voltage (per MIL-STD-883, Method 3015)	>4001V

Latch-Up Current	>200 mA
UV Exposure	7258 Wsec/cm ²

Operating Range

Range	Ambient Temperature	V _{CC}
Commercial	0°C to +70°C	5V ±10%
Industrial ^[1]	-40°C to +85°C	5V ±10%
Military ^[2]	-55°C to +125°C	5V ±10%

Electrical Characteristics Over the Operating Range^[3, 4]

Parameter	Description	Test Conditions	7C271A-25 7C271A-30		7C271A-35		7C271A-45 7C271A-55		Unit
			Min.	Max.	Min.	Max.	Min.	Max.	
V _{OH}	Output HIGH Voltage	V _{CC} = Min., I _{OH} = -2.0 mA	2.4		2.4		2.4		V
V _{OL}	Output LOW Voltage	V _{CC} = Min., I _{OL} = 8.0 mA		0.4		0.4		0.4	V
V _{IH}	Input HIGH Level	Guaranteed Input Logical HIGH Voltage for All Inputs	2.0	V _{CC}	2.0	V _{CC}	2.0	V _{CC}	V
V _{IL}	Input LOW Level	Guaranteed Input Logical LOW Voltage for All Inputs		0.8		0.8		0.8	V
I _{IX}	Input Leakage Current	GND ≤ V _{IN} ≤ V _{CC}	-10	+10	-10	+10	-10	+10	µA
I _{OZ}	Output Leakage Current	GND ≤ V _{OUT} ≤ V _{CC} , Output Disable	-10	+10	-10	+10	-10	+10	µA
I _{OS}	Output Short Circuit Current ^[5]	V _{CC} = Max., V _{OUT} = GND	-20	-90	-20	-90	-20	-90	mA
I _{CC}	Power Supply Current	V _{CC} = Max., I _{OUT} = 0 mA, f = 10 MHz	Com'l	75		50		50	mA
			Mil			85		60	mA
I _{SB}	Stand-By Current	V _{CC} = Max., CE = V _{IH}	Com'l	15		15		15	mA
			Mil			25		25	mA

Capacitance^[4]

Parameter	Description	Test Conditions	Max.	Unit
C _{IN}	Input Capacitance	T _A = 25°C, f = 1 MHz, V _{CC} = 5.0V	10	pF
C _{OUT}	Output Capacitance		10	pF

Notes:

- Contact a Cypress representative for information on industrial temperature range specifications.
- T_A is the "instant on" case temperature.
- See the last page of this specification for Group A subgroup testing information.
- See Introduction to CMOS PROMs in this Data Book for general information on testing.
- For test purposes, not more than one output at a time should be shorted. Short circuit test duration should not exceed 30 seconds.

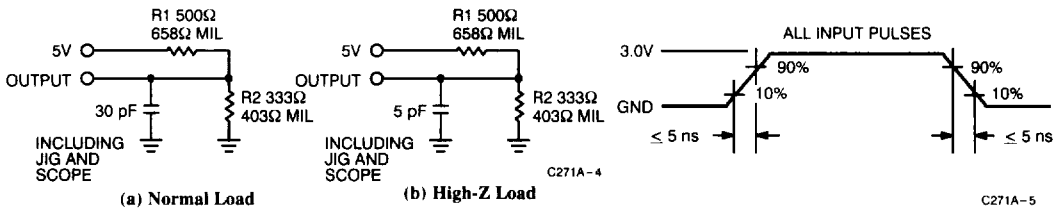
AC Test Loads and Waveforms

Equivalent to: THEVENIN EQUIVALENT

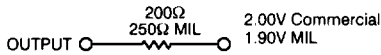
Switching Characteristics Over the Operating Range^[3, 4]

Parameter	Description	7C271A-25		7C271A-30		7C271A-35		7C271A-45		7C271A-55		Unit
		Min.	Max.	Min.	Max.	Min.	Max.	Min.	Max.	Min.	Max.	
t_{AA}	Address to Output Valid		25		30		35		45		55	ns
t_{ACS}	$\overline{CS}_1/\overline{CS}_2$ Active to Output Valid		12		15		15		15		20	ns
t_{ACE}	\overline{CE} Active to Output Valid		30		35		35		45		55	ns
t_{HZCS}	$\overline{CS}_1/\overline{CS}_2$ Inactive to High Z		12		15		15		15		20	ns
t_{HZCE}	\overline{CE} Inactive to High Z		12		15		15		15		20	ns
t_{PU}	\overline{CE} Active to Power-Up	0		0		0		0		0		ns
t_{PD}	\overline{CE} Inactive to Power-Down		30		35		40		40		50	ns
t_{OH}	Output Data Hold	0		0		0		0		0		ns

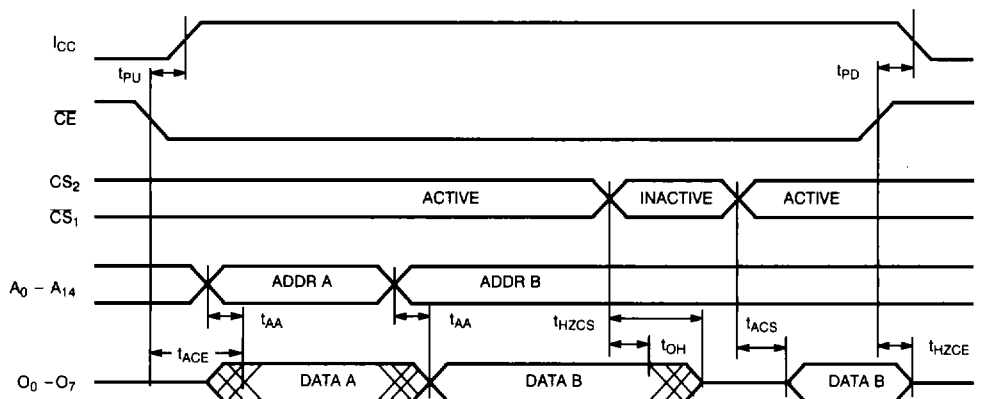
Switching Waveform

C271A-6

Erasure Characteristics

Wavelengths of light less than 4000 Å begin to erase the CY7C271A in the windowed package. For this reason, an opaque label should be placed over the window if the PROM is exposed to sunlight or fluorescent lighting for extended periods of time.

The recommended dose of ultraviolet light for erasure is a wavelength of 2537 Å for a minimum dose (UV intensity multiplied by exposure time) of 25 Wsec/cm². For an ultraviolet lamp with a 12 mW/cm² power rating, the exposure time would be approximately 35 minutes. The CY7C271A needs to be within 1 inch of the lamp

during erasure. Permanent damage may result if the PROM is exposed to high-intensity UV light for an extended period of time. 7258 Wsec/cm² is the recommended maximum dosage.

Programming Modes

Programming support is available from Cypress as well as from a number of third-party software vendors. For detailed programming information, including a listing of software packages, please see the PROM Programming Information located at the end of this section. Programming algorithms can be obtained from any Cypress representative.

Table 1. Programming Electrical Characteristics

Parameter	Description	Min.	Max.	Unit
V _{PP}	Programming Power Supply	12.5	13	V
I _{PP}	Programming Supply Current		50	mA
V _{IHP}	Programming Input Voltage HIGH	3.0	V _{CC}	V
V _{ILP}	Programming Input Voltage LOW	-0.5	0.4	V
V _{CCP}	Programming V _{CC}	6.0	6.5	V

Table 2. Mode Selection

Mode	Pin Function ^[6]					
	CS ₁ /V _{PP}	CS ₂ /PGM	CE/VFY	A ₀	A ₉	Data
Read	V _{IL}	V _{IH}	V _{IL}	A ₀	A ₉	O ₇ - O ₀
Output Disable	V _{IH}	V _{IH}	V _{IL}	A ₀	A ₉	High Z
Output Disable	V _{IL}	V _{IL}	V _{IL}	A ₀	A ₉	High Z
Stand-by	X	X	V _{IH}	A ₀	A ₉	High Z
Program	V _{PP}	V _{ILP}	V _{IHP}	A ₀	A ₉	D ₇ - D ₀
Program Verify	V _{PP}	V _{IHP}	V _{ILP}	A ₀	A ₉	O ₇ - O ₀
Program Inhibit	V _{PP}	V _{IHP}	V _{IHP}	X	X	X
Signature (MFG)	V _{ILP}	V _{ILP}	V _{ILP}	V _{ILP}	V _{HV} ^[7]	34H
Signature (DEV)	V _{ILP}	V _{ILP}	V _{ILP}	V _{IHP}	V _{HV} ^[7]	20H

Notes:

6. X can be V_{IL} or V_{IH}.

7. V_{HV} = 12 ± 0.5V

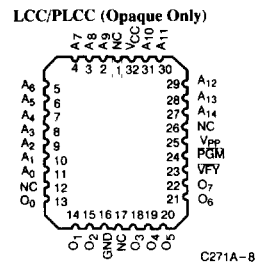
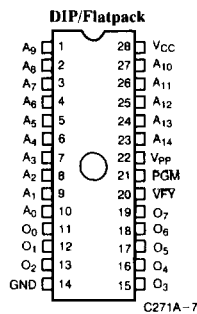
Programming Pinouts

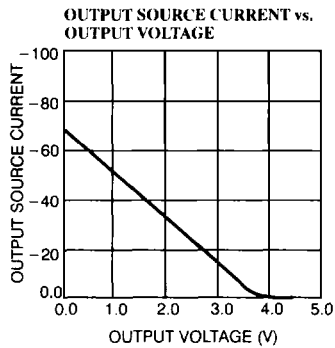
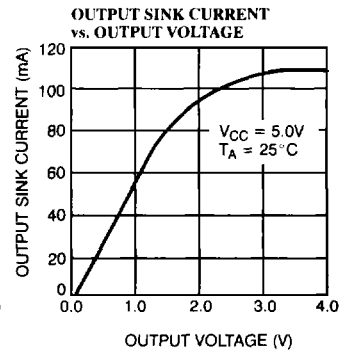
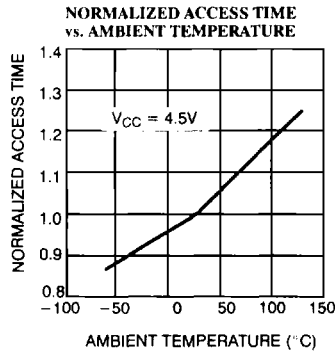
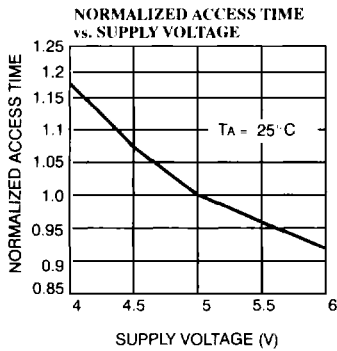
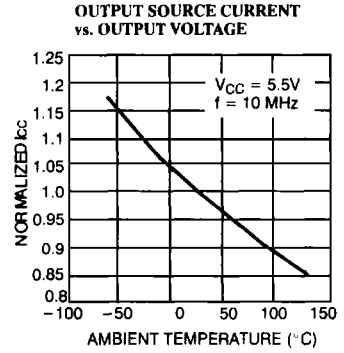
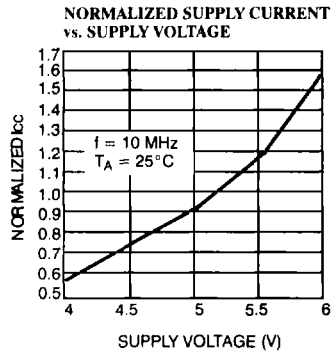
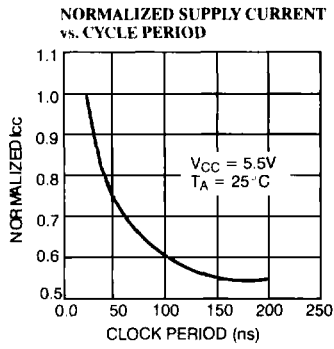
Typical DC and AC Characteristics

Ordering Information⁽⁸⁾

Speed (ns)	Ordering Code	Package Name	Package Type	Operating Range
25	CY7C271A-25JC	J65	32-Lead Plastic Leaded Chip Carrier	Commercial
30	CY7C271A-30JC	J65	32-Lead Plastic Leaded Chip Carrier	Commercial
	CY7C271A-30PC	P21	28-Lead (300-Mil) Molded DIP	
	CY7C271A-30WC	W22	28-Lead (300-Mil) Windowed CerDIP	
35	CY7C271A-35JC	J65	32-Lead Plastic Leaded Chip Carrier	Commercial
	CY7C271A-35PC	P21	28-Lead (300-Mil) Molded DIP	
	CY7C271A-35WC	W22	28-Lead (300-Mil) Windowed CerDIP	
	CY7C271A-35DMB	D22	28-Lead (300-Mil) CerDIP	Military
	CY7C271A-35KMB	K74	28-Lead Rectangular Cerpack	
	CY7C271A-35LMB	L55	32-Pin Rectangular Leadless Chip Carrier	
	CY7C271A-35QMB	Q55	32-Pin Windowed Rectangular Leadless Chip Carrier	
	CY7C271A-35TMB	T74	28-Lead Windowed Cerpack	
	CY7C271A-35WMB	W22	28-Lead (300-Mil) Windowed CerDIP	
45	CY7C271A-45JC	J65	32-Lead Plastic Leaded Chip Carrier	Commercial
	CY7C271A-45PC	P21	28-Lead (300-Mil) Molded DIP	
	CY7C271A-45WC	W22	28-Lead (300-Mil) Windowed CerDIP	
	CY7C271A-45DMB	D22	28-Lead (300-Mil) CerDIP	Military
	CY7C271A-45KMB	K74	28-Lead Rectangular Cerpack	
	CY7C271A-45LMB	L55	32-Pin Rectangular Leadless Chip Carrier	
	CY7C271A-45QMB	Q55	32-Pin Windowed Rectangular Leadless Chip Carrier	
	CY7C271A-45TMB	T74	28-Lead Windowed Cerpack	
	CY7C271A-45WMB	W22	28-Lead (300-Mil) Windowed CerDIP	
55	CY7C271A-55JC	J65	32-Lead Plastic Leaded Chip Carrier	Commercial
	CY7C271A-55PC	P21	28-Lead (300-Mil) Molded DIP	
	CY7C271A-55WC	W22	28-Lead (300-Mil) Windowed CerDIP	
	CY7C271A-55DMB	D22	28-Lead (300-Mil) CerDIP	Military
	CY7C271A-55KMB	K74	28-Lead Rectangular Cerpack	
	CY7C271A-55LMB	L55	32-Pin Rectangular Leadless Chip Carrier	
	CY7C271A-55QMB	Q55	32-Pin Windowed Rectangular Leadless Chip Carrier	
	CY7C271A-55TMB	T74	28-Lead Windowed Cerpack	
	CY7C271A-55WMB	W22	28-Lead (300-Mil) Windowed CerDIP	

Note:

8. Most of these products are available in industrial temperature range. Contact a Cypress representative for specifications and product availability.



MILITARY SPECIFICATIONS
Group A Subgroup Testing

DC Characteristics

Parameter	Subgroups
V _{OH}	1, 2, 3
V _{OL}	1, 2, 3
V _{IH}	1, 2, 3
V _{IL}	1, 2, 3
I _{Ix}	1, 2, 3
I _{OZ}	1, 2, 3
I _{CC}	1, 2, 3
I _{SB}	1, 2, 3

Switching Characteristics

Parameter	Subgroups
t _{AA}	7, 8, 9, 10, 11
t _{ACS}	7, 8, 9, 10, 11
t _{ACE}	7, 8, 9, 10, 11

Document #: 38-00424