



[Back to search results](#)

78255

Contact your local Sales Associate for availability

Pricing

| | | |
|-----------------------------------|------------------------------------|------------------------------------|
| 8.2 feet: \$93.75 per foot | 32.8 feet: \$23.44 per foot | 57.4 feet: \$13.39 per foot |
|-----------------------------------|------------------------------------|------------------------------------|

|  | Part Number | Thermal Resistance °C/W at 3in length | Width in | Height in | Surface Area in/in | Weight lb/ft | Part Class |
|---|-------------|---------------------------------------|----------|-----------|--------------------|--------------|------------|
| | 78255 | 11.51 | 1.06 | 1.06 | 6.1 | 0.40 | B |

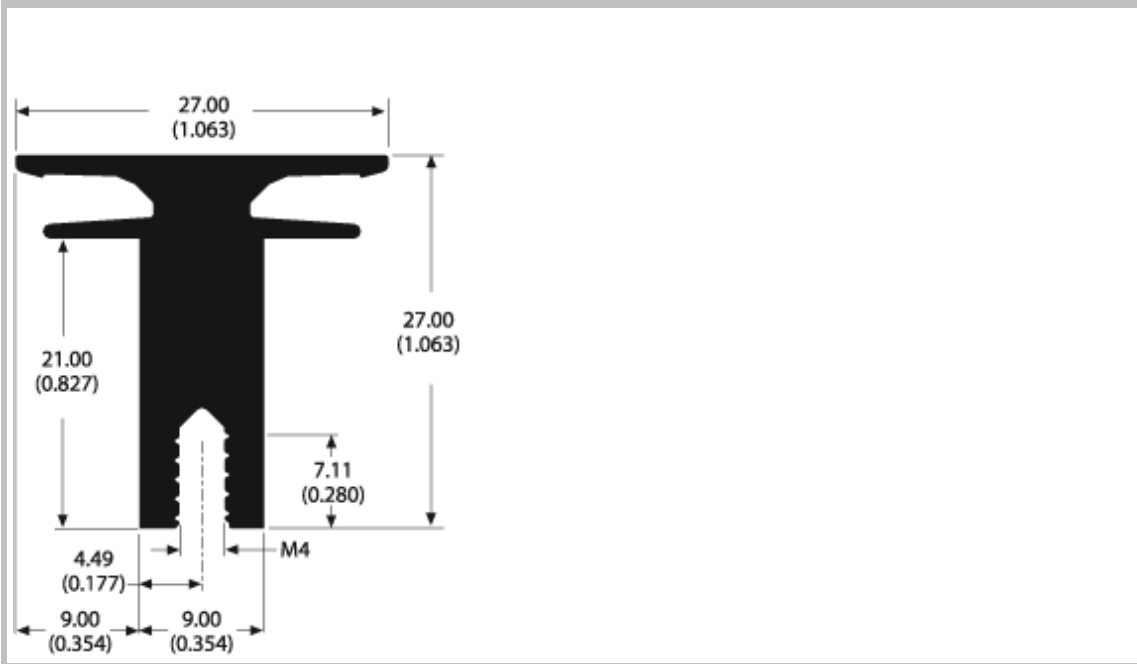

Thermal Curves

based on 3.000 in length

New Length in mm

[Change Length](#)

Natural Convection

Heat Sink Temperature Rise Above Ambient

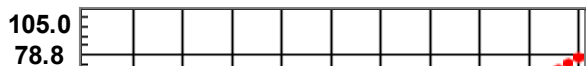

Heat Sink Thermal Resistance

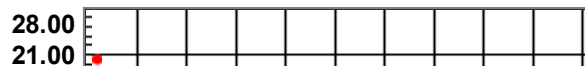

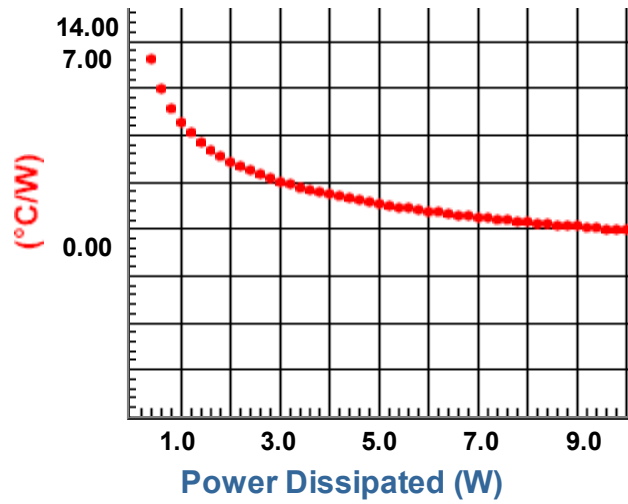
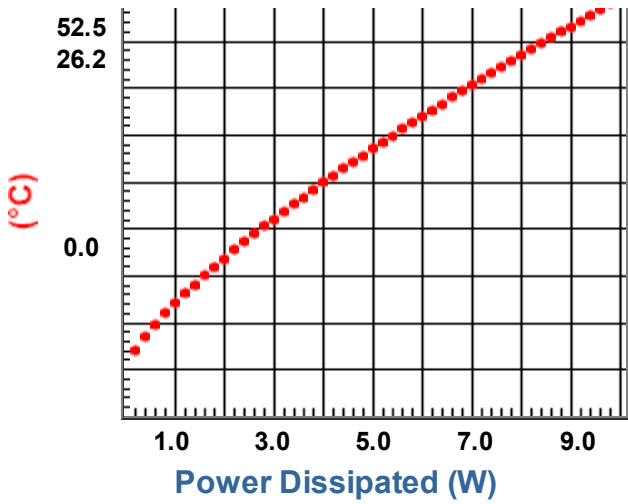

Forced Convection

Heat Sink Temperature Rise Above Ambient (10W Dissipated)

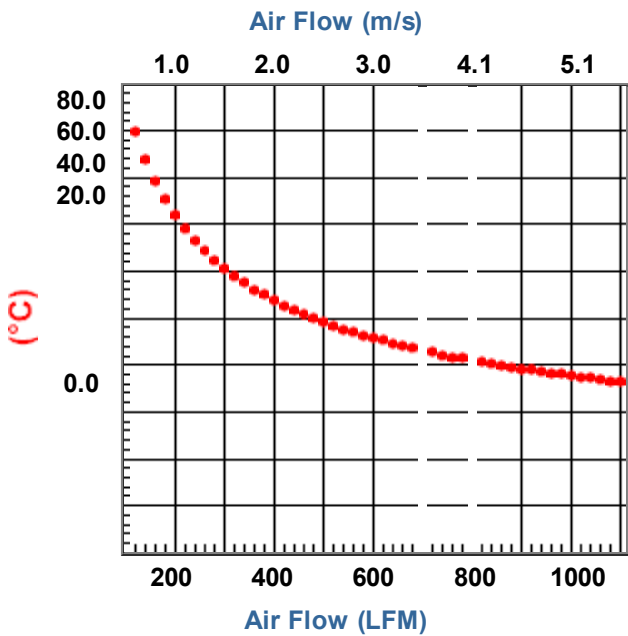

Heat Sink Thermal Resistance

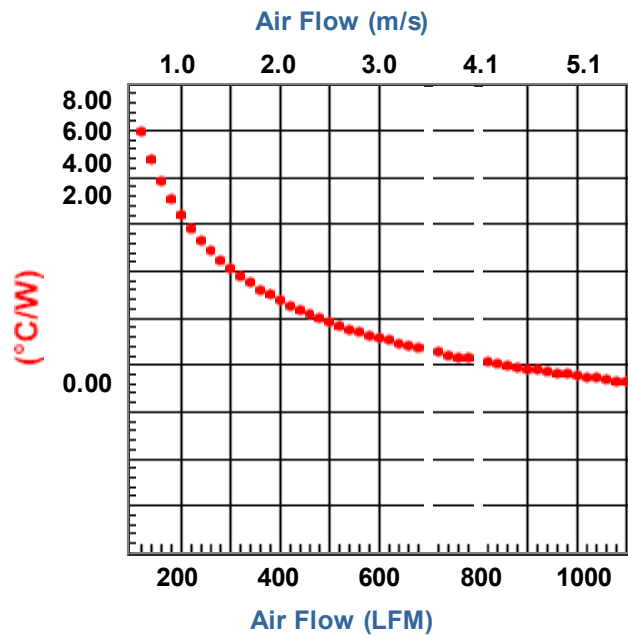

Building a Part Number

Full Bar Length = 8.20ft

| Base Part # | Bar Length | Finish | Length (use zeros for full or half bars) | RoHS |
|---------------------|---|--|--|-------------------|
| 5 digit base part # | <u>1</u> Full (normally 8-ft) | <u>F</u> Unfinished | 0 0 0 0 | Compliant |
| | <u>2</u> Half (small cut fee) | <u>F</u> Unfinished | 0 0 0 0 | NO "G" required |
| | <u>3</u> Custom (cut to specified length) | <u>B</u> Black Anodized <u>U</u> Unfinished* <u>V</u> AavSHIELD ³ | length in inches to three decimal places** | Compliant Add "G" |
| | | <u>C</u> Gold Chromate | | Not Compliant |

78255

3

U

06500

G

*For unfinished extrusions with cut lengths other than half bar, the finish designation is a U.

**If the part is less than 10 inches, the first of these 5 digits (digit 7 of the 13 digit series) would be a zero (0).

Examples:

If you wanted to simply order extrusion # 78255 in standard bar form, the part number would be: 782551F00000. The unit price would be sold by the foot.

If you wanted extrusion 78255 cut to a length of 6.500" and black anodized, the part number would be: 782553B06500G. The unit price would be by the piece.

If you wanted extrusion 78255 cut to a length of 14.725" and a wash finish, the part number would be: 782553U14725G. The unit price would be by the piece.

If you wanted extrusion 78255 cut to a length of 14.725" and Gold Chromate finish, the part number would be: 782553C14725. The unit price would be by the piece.

Standard Aavid Thermalloy parts require all 12-13 positions to be complete.

Non-Standard Extrusions

Aavid Thermalloy has over 10,000 extrusion profile designs on file, most with the extrusion die already available. These parts have minimum order requirements and longer lead times, but may be cost effective compared to a new design.

Customizing & Advanced Capabilities

We offer several options for those applications which require a more unique solution. Challenge us with your thermal requirements - we can design custom solutions.

©2012 Aavid Thermalloy, LLC