

DMC 1,5/ 4-G1F-3,5-LR P20THR - PCB header



1787030

<https://www.phoenixcontact.com/us/products/1787030>

Please be informed that the data shown in this PDF document is generated from our Online Catalog. Please find the complete data in the user documentation. Our General Terms of Use for Downloads are valid.



PCB headers, nominal cross section: 1.5 mm², color: black, nominal current: 8 A, rated voltage (III/2): 160 V, contact surface: Tin, type of contact: Pin, number of potentials: 8, number of rows: 2, number of positions: 4, number of connections: 8, product range: DMC 1,5/..-G1F-THR, pitch: 3.5 mm, mounting: THR soldering, pin layout: Linear pinning, solder pin [P]: 2 mm, number of solder pins per potential: 1, plug-in system: COMBICON DFMC 1,5, Pin connector pattern alignment: Standard, locking: Snap-in locking, mounting: Lock & release threaded flange, type of packaging: packed in cardboard

Your advantages

- Designed for integration into the SMT soldering process
- Screwable flange for superior mechanical stability
- Automatic locking and intuitive release through Lock and Release operating lever in contrasting color
- Conductor connection on several levels enables higher contact density
- Small component size for applications where space is at a premium

Commercial Data

Item number	1787030
Packing unit	1 pc
Minimum order quantity	50 pc
Sales Key	AA02
Product Key	AABTJA
Catalog Page	Page 187 (C-1-2013)
GTIN	4046356596541
Weight per Piece (including packing)	2.984 g
Weight per Piece (excluding packing)	2.984 g
Customs tariff number	85366930
Country of origin	DE

DMC 1,5/ 4-G1F-3,5-LR P20THR - PCB header



1787030

<https://www.phoenixcontact.com/us/products/1787030>

Technical Data

Product properties

Type	Headers
Product line	COMBICON Connectors S
Product type	PCB headers
Product family	DMC 1,5/...-G1F-THR
Number of positions	4
Pitch	3.5 mm
Number of connections	8
Number of rows	2
Mounting flange	Lock & release threaded flange
Number of potentials	8
Pin layout	Linear pinning
Solder pins per potential	1

Electrical properties

Nominal current I_N	8 A
Nominal voltage U_N	160 V
Degree of pollution	3
Contact resistance	2 mΩ
Rated voltage (III/3)	160 V
Rated surge voltage (III/3)	2.5 kV
Rated voltage (III/2)	160 V
Rated surge voltage (III/2)	2.5 kV
Rated voltage (II/2)	250 V
Rated surge voltage (II/2)	2.5 kV

Mounting

Mounting type	THR soldering
Pin layout	Linear pinning

Flange

Tightening torque	0.2 Nm
-------------------	--------

Processing notes

Process	Reflow/wave soldering
Moisture Sensitive Level	MSL 1
Classification temperature T_c	260 °C
Solder cycles in the reflow	3

Material specifications

Material data - contact

Note	WEEE/RoHS-compliant, free of whiskers according to IEC
------	--

DMC 1,5/ 4-G1F-3,5-LR P20THR - PCB header



1787030

<https://www.phoenixcontact.com/us/products/1787030>

	60068-2-82/JEDEC JESD 201
Contact material	Cu alloy
Surface characteristics	Tin-plated
Metal surface contact area (top layer)	Tin (3 - 5 μm Sn)
Metal surface contact area (middle layer)	Nickel (1 - 3 μm Ni)
Metal surface soldering area (top layer)	Tin (3 - 5 μm Sn)
Metal surface soldering area (middle layer)	Nickel (1 - 3 μm Ni)

Material data - housing

Color (Housing)	black (9005)
Insulating material	LCP
Insulating material group	IIIa
CTI according to IEC 60112	175
Flammability rating according to UL 94	V0

Material data – actuating element

Color ()	()
----------	----

Dimensions

Dimensional drawing	
Pitch	3.5 mm
Width [w]	21 mm
Height [h]	12.8 mm
Length [l]	11.6 mm
Installed height	10.8 mm
Solder pin length [P]	2 mm

PCB design

Pin spacing	2.50 mm
-------------	---------

Mechanical tests

Test for conductor damage and slackening

Specification	IEC 60999-1:1999-11
Result	Test passed

Repeated connection and disconnection

Specification	IEC 60999-1:1999-11
Result	Test passed

Pull-out test

Specification	IEC 60999-1:1999-11
---------------	---------------------

DMC 1,5/ 4-G1F-3,5-LR P20THR - PCB header



1787030

<https://www.phoenixcontact.com/us/products/1787030>

Conductor cross section/conductor type/tractive force setpoint/actual value	0.2 mm ² / solid / > 10 N
	0.2 mm ² / flexible / > 10 N
	1.5 mm ² / solid / > 40 N
	1.5 mm ² / flexible / > 40 N

Insertion and withdrawal forces

Result	Test passed
No. of cycles	25
Insertion strength per pos. approx.	3 N
Withdraw strength per pos. approx.	2 N

Contact holder in insert

Specification	IEC 60512-15-1:2008-05
Contact holder in insert Requirements >20 N	Test passed

Resistance of inscriptions

Specification	IEC 60068-2-70:1995-12
Result	Test passed

Polarization and coding

Specification	IEC 60512-13-5:2006-02
Result	Test passed

Visual inspection

Specification	IEC 60512-1-1:2002-02
Result	Test passed

Dimension check

Specification	IEC 60512-1-2:2002-02
Result	Test passed

Electrical tests

Thermal test | Test group C

Specification	IEC 60512-5-1:2002-02
Tested number of positions	20

Insulation resistance

Specification	IEC 60512-3-1:2002-02
Insulation resistance, neighboring positions	> 5 MΩ

Temperature cycles

Specification	IEC 60999-1:1999-11
Result	Test passed

Air clearances and creepage distances |

Specification	IEC 60664-1:2007-04
Insulating material group	IIIa

DMC 1,5/ 4-G1F-3,5-LR P20THR - PCB header



1787030

<https://www.phoenixcontact.com/us/products/1787030>

Comparative tracking index (IEC 60112)	CTI 175
Rated insulation voltage (III/3)	160 V
Rated surge voltage (III/3)	2.5 kV
minimum clearance value - non-homogenous field (III/3)	1.5 mm
minimum creepage distance (III/3)	2.5 mm
Rated insulation voltage (III/2)	160 V
Rated surge voltage (III/2)	2.5 kV
minimum clearance value - non-homogenous field (III/2)	1.5 mm
minimum creepage distance (III/2)	1.6 mm
Rated insulation voltage (II/2)	250 V
Rated surge voltage (II/2)	2.5 kV
minimum clearance value - non-homogenous field (II/2)	1.5 mm
minimum creepage distance (II/2)	2.5 mm

Environmental and real-life conditions

Vibration test

Specification	IEC 60068-2-6:2007-12
Frequency	10 - 150 - 10 Hz
Sweep speed	1 octave/min
Amplitude	0.35 mm (10 Hz ... 60.1 Hz)
Sweep speed	50 m/s ² (60.1 Hz ... 150 Hz)
Test duration per axis	2.5 h

Durability test

Specification	IEC 60512-9-1:2010-03
Impulse withstand voltage at sea level	2.95 kV
Contact resistance R ₁	2 mΩ
Contact resistance R ₂	2.3 mΩ
Insertion/withdrawal cycles	25
Insulation resistance, neighboring positions	> 5 MΩ

Climatic test

Specification	ISO 6988:1985-02
Corrosive stress	0.2 dm ³ SO ₂ on 300 dm ³ /40 °C/1 cycle
Thermal stress	105 °C/168 h
Power-frequency withstand voltage	1.39 kV

Ambient conditions

Ambient temperature (operation)	-40 °C ... 100 °C (dependent on the derating curve)
Ambient temperature (storage/transport)	-40 °C ... 70 °C
Relative humidity (storage/transport)	30 % ... 70 %
Ambient temperature (assembly)	-5 °C ... 100 °C

Packaging specifications

Type of packaging	packed in cardboard
-------------------	---------------------

Drawings

Diagram

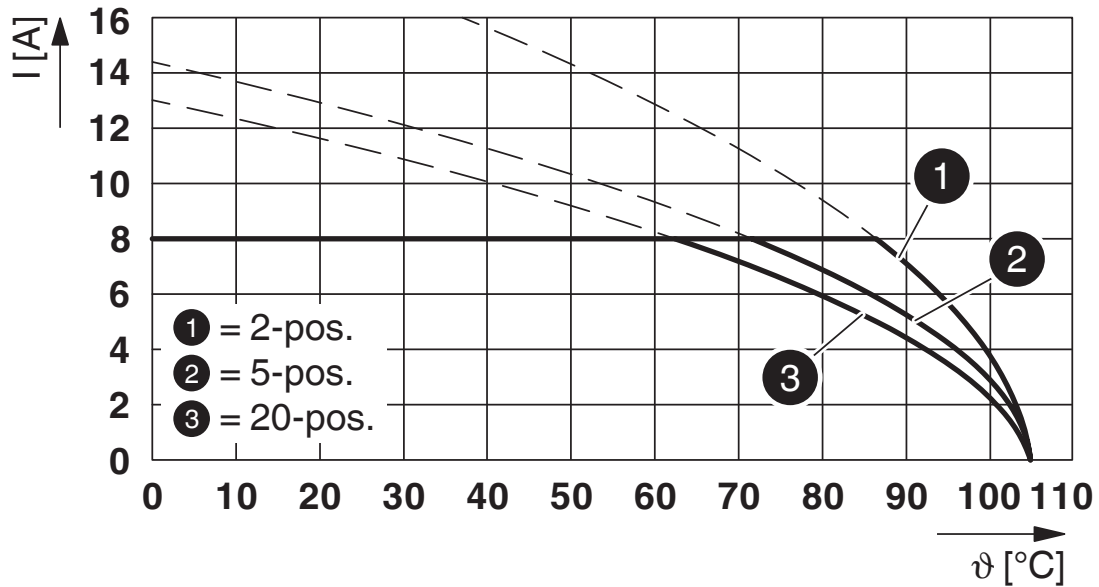

Type: DFMC 1,5/...-ST-3,5-LR with DMC 1,5/...-G1F-3,5-LR P...THR

Schematic diagram

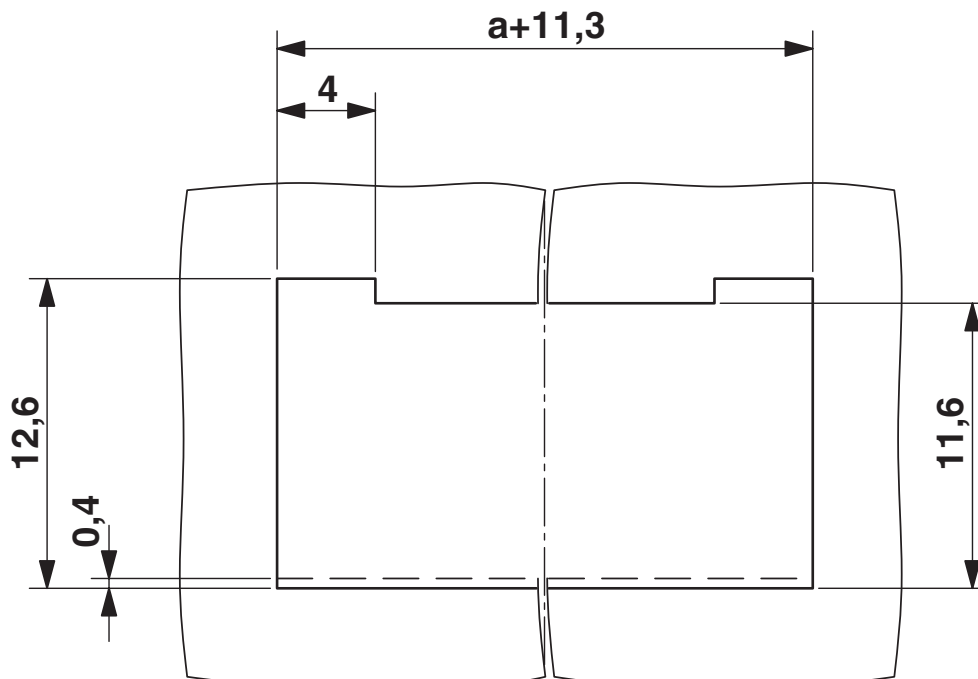

Panel cutout

DMC 1,5/ 4-G1F-3,5-LR P20THR - PCB header

1787030

<https://www.phoenixcontact.com/us/products/1787030>

Dimensional drawing

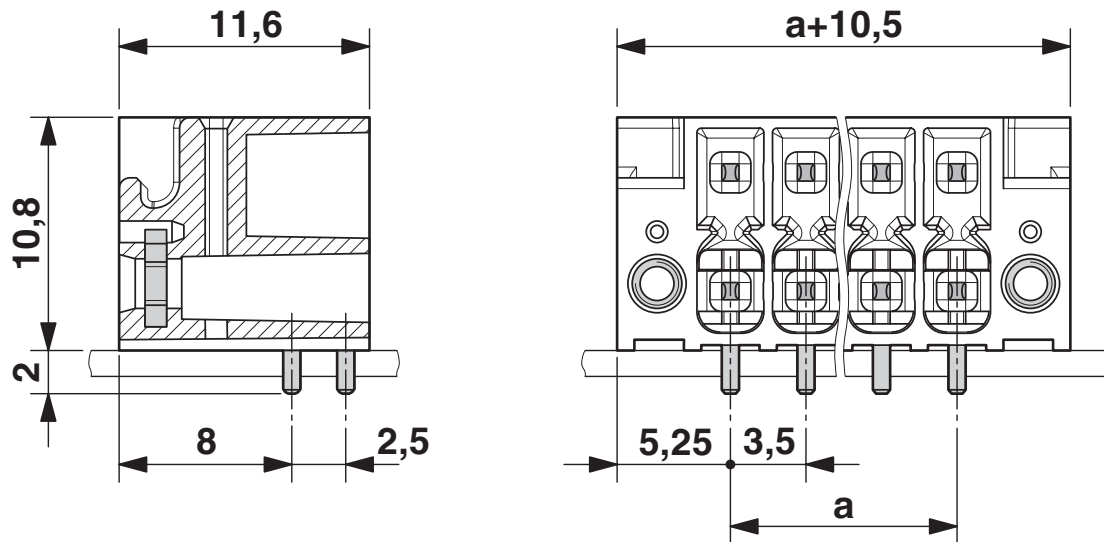

Drilling plan/solder pad geometry

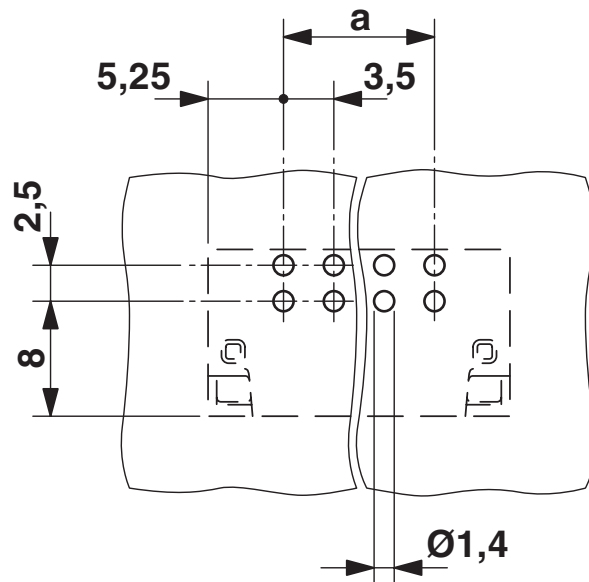

DMC 1,5/ 4-G1F-3,5-LR P20THR - PCB header

1787030

<https://www.phoenixcontact.com/us/products/1787030>

Schematic diagram



Use of the CP-DMC... coding profile

Diagram

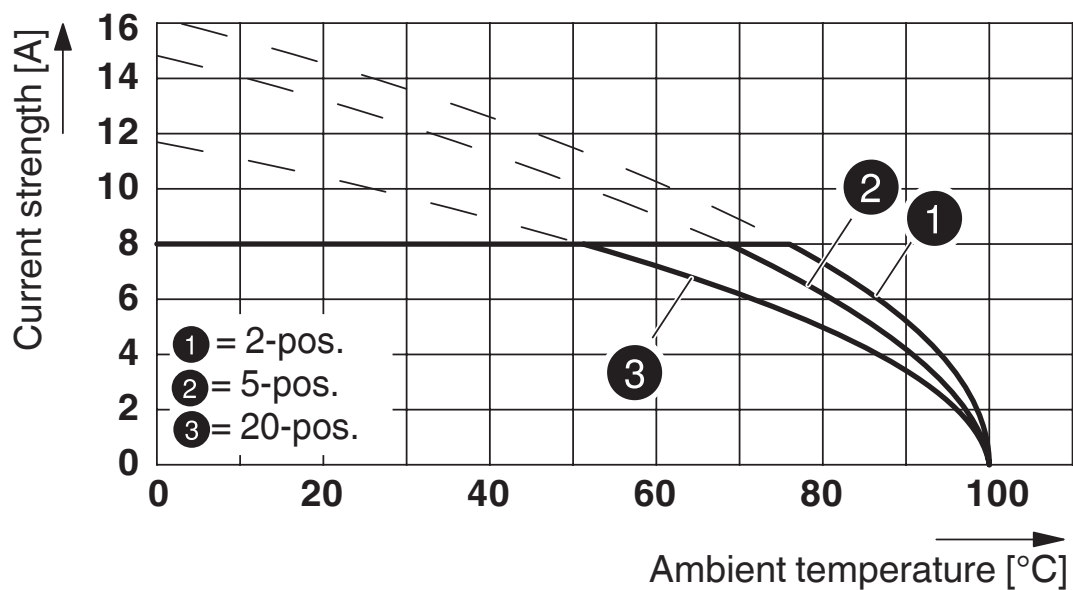

Type: DFMC 1,5/...-STF-3,5 with DMC 1,5/...-G1F-3,5-LR P...THR

DMC 1,5/ 4-G1F-3,5-LR P20THR - PCB header





1787030

<https://www.phoenixcontact.com/us/products/1787030>

Approvals

 IECEE CB Scheme Approval ID: DE1-60359-B1B2				
	Nominal Voltage U_N	Nominal Current I_N	Cross Section AWG	Cross Section mm^2
	160 V	8 A	-	-

 EAC Approval ID: B.01687				
--	--	--	--	--

 cULus Recognized Approval ID: E60425-20110128				
	Nominal Voltage U_N	Nominal Current I_N	Cross Section AWG	Cross Section mm^2
Use group B	150 V	8 A	-	-
Use group C	50 V	8 A	-	-
Use group D	300 V	8 A	-	-

 VDE Gutachten mit Fertigungsüberwachung Approval ID: 40038423				
	Nominal Voltage U_N	Nominal Current I_N	Cross Section AWG	Cross Section mm^2
	160 V	8 A	-	-

DMC 1,5/ 4-G1F-3,5-LR P20THR - PCB header



1787030

<https://www.phoenixcontact.com/us/products/1787030>

Classifications

ECLASS

ECLASS-10.0.1	27440402
ECLASS-11.0	27460201
ECLASS-12.0	27460201

ETIM

ETIM 8.0	EC002637
----------	----------

UNSPSC

UNSPSC 21.0	39121400
-------------	----------

DMC 1,5/ 4-G1F-3,5-LR P20THR - PCB header



1787030

<https://www.phoenixcontact.com/us/products/1787030>

Environmental Product Compliance

China RoHS	Environmentally friendly use period: unlimited = EFUP-e
	No hazardous substances above threshold values

DMC 1,5/ 4-G1F-3,5-LR P20THR - PCB header



1787030

<https://www.phoenixcontact.com/us/products/1787030>

Accessories

CP-DMC 1,5 NAT - Coding profile

1790647

<https://www.phoenixcontact.com/us/products/1790647>

Coding profile, for insertion between the coding ribs of the connector and the header following the reflow soldering process, insulating material, color: natural



DFMC 1,5/ 4-STF-3,5 - PCB connector

1790315

<https://www.phoenixcontact.com/us/products/1790315>

Plug, nominal current: 8 A, rated voltage (III/2): 160 V, number of positions: 4 with 8 contacts, pitch: 3.5 mm, connection method: spring-cage connection, color: green, contact surface: tin

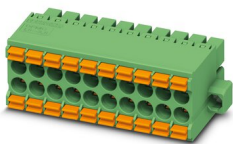

DMC 1,5/ 4-G1F-3,5-LR P20THR - PCB header

1787030

<https://www.phoenixcontact.com/us/products/1787030>



DFMC 1,5/ 4-ST-3,5-LR - PCB connector

1790506

<https://www.phoenixcontact.com/us/products/1790506>

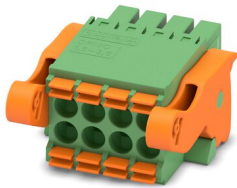

Plug, nominal current: 8 A, rated voltage (III/2): 160 V, number of positions: 4 with 8 contacts, pitch: 3.5 mm, connection method: spring-cage connection, color: green, contact surface: tin

Phoenix Contact 2023 © - all rights reserved

<https://www.phoenixcontact.com>

Phoenix Contact USA
586 Fulling Mill Road
Middletown, PA 17057, United States
(+717) 944-1300
info@phoenixcon.com