

O14-Series Specifications



20.40L x 12.80W x 9.14H (mm)

PDI Model *O14-Series* provides precision timing in a hermetically sealed Dip14 package, and is available in both standard and custom frequencies and configurations. PDI provides quick-turn sampling for your proto-typing needs, mass production capability, and competitive pricing.

ex) **O14—T—25000X—C—D—B—3—X—X***

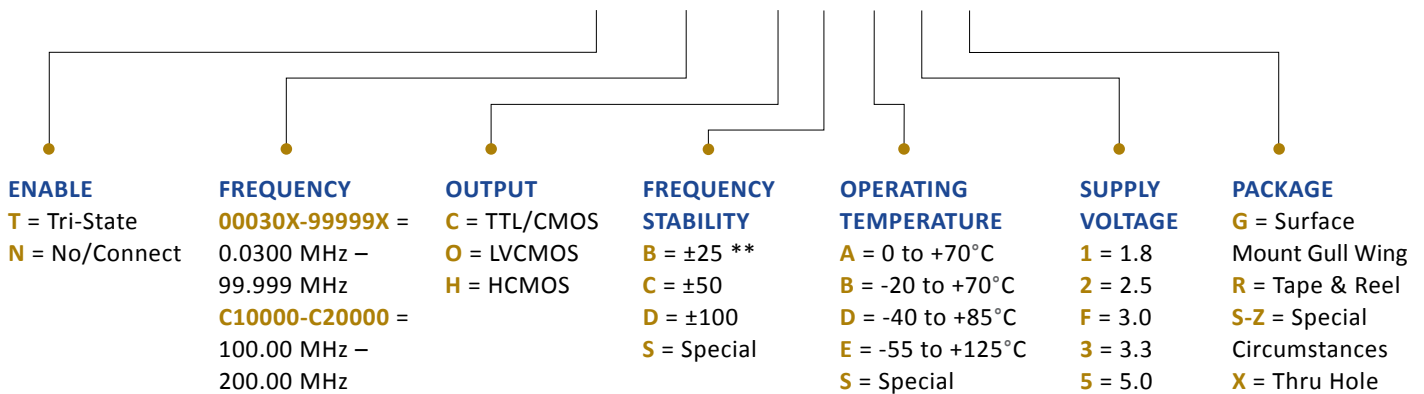

** - Not available -55 to +125°C

* - for standard or assigned for customization.

Parameter		Supply Voltage ^{*1} (±10%)					Units
		5.0	3.3	3.0	2.5	1.8	V
Frequency Range ^{*1}	Low	0.030000					MHz
	High	166.000	200.000				
Frequency Stability ^{*1}	All Causes (Maximum) ^{*2}	Per Option					ppm
Temperature Range ^{*1}	Operating	Per Option					°C
	Storage	- 55 to +125					°C
Supply Current (Maximum)	0.030000 to 23.999999 MHz	20	15	15	15	10	mA
	24.000000 to 49.999999 MHz	30	20	20	20	12	
	50.000000 to 69.999999 MHz	40	30	30	30	15	
	70.000000 to 200.000000 MHz	60	45	45	45	25	
Output Options		C & H	C & O				
Load		15pF/10 TTL gates					
Duty Cycle (at 50% Vcc)		40 to 60% (45 to 55% option)					
Rise/Fall Times (Maximum)	Rise Time (10% to 90% Vcc)	10	8	8	7	6	ns
	Fall Time (90% to 10% Vcc)	10	8	8	7	6	
Start up Time (Maximum)		10					ms
Output Voltage Levels	High (Minimum)	90					% Vcc
	Low (Maximum)	10					
Pin 1 (Tri-State) (Option)	High (See below) or Open	Enable					
	Low (See below) ^{*3}	Disable					
	High Value (Minimum)	80	80	80	80	80	% Vcc
	Low Value (Maximum) ^{*3}	20	20	20	20	20	% Vcc
	Disable Current (Maximum) ^{*3}	10	10	10	10	10	uA
	Enable Delay Time (Maximum)	10					ms
	Disable Delay Time (Maximum)	150					ns

*1 - Not all Frequency/Temperature/Voltage combinations are available.

*2 - Inclusive of Tolerance @25°C, Operating Temperature, Supply Voltage, Load, Aging, Shock and Vibration.

*3 - Internal crystal oscillation halted.

O14-Series 20.40 x 12.80 x 9.14 (mm)

PACKAGE DIMENSIONS

Decimal XXX = ± .008, XX = ± .02 Metric [XXX = ± .20], [XX = ± .50]

PIN	CONNECTION
1	Tri-State or No Connect
7	Ground/Case
8	Output
14	Supply Voltage

Thru Hole Option

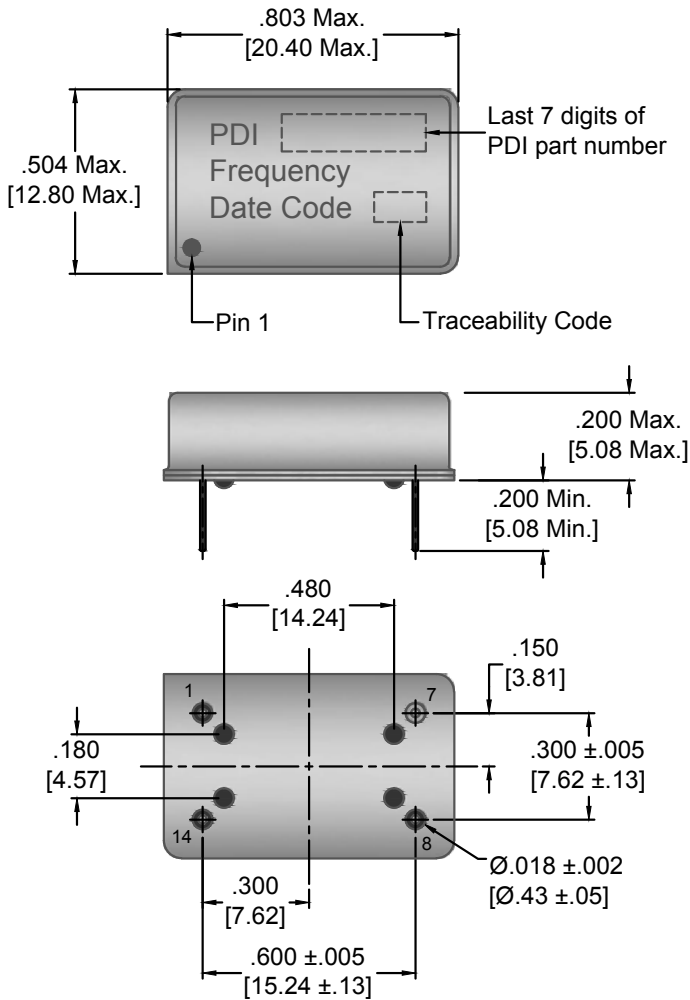

Gull Wing Option

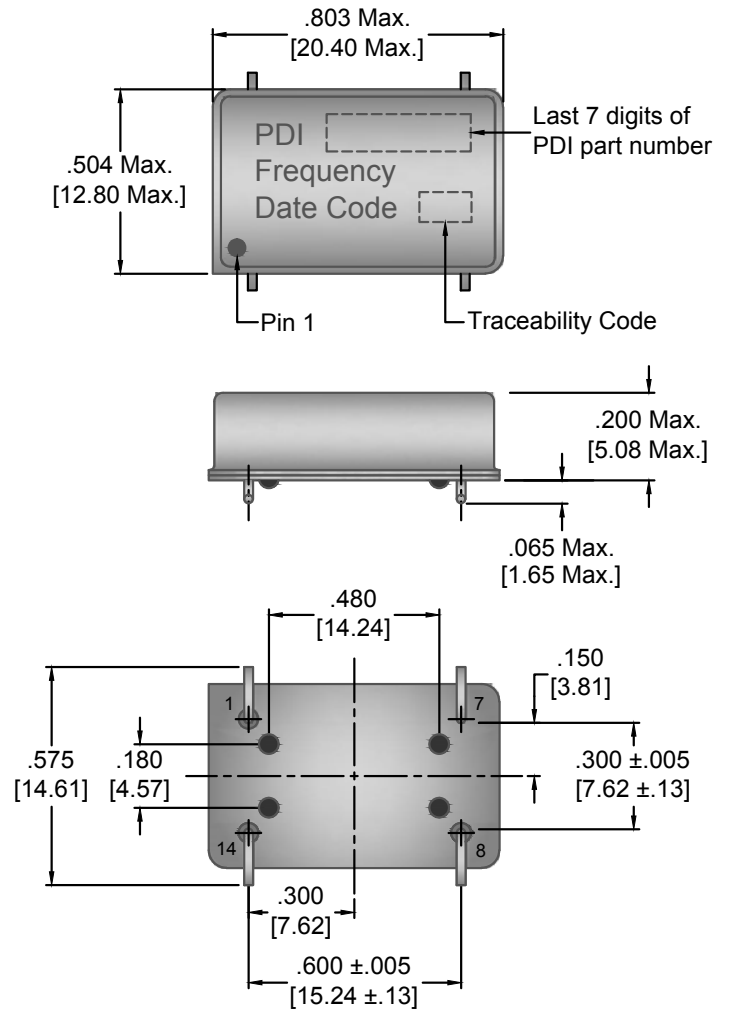

NOTES:

Other options are available, please consult factory.
 All product is supplied RoHS and REACH compliant.
 Product can be supplied on Tape and Reel, on reels of 1,000 units.
 Specifications subject to change without notice, last updated 4/1/13.