

**Features**

- Low power consumption
- Robust package
- I.C. Compatible
- Standard configuration: Gray face w/ white dots
- Optional black face provides superior color contrast
- RoHS Compliant

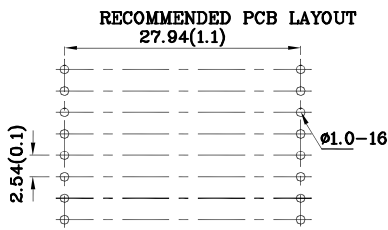

**Package Schematics**

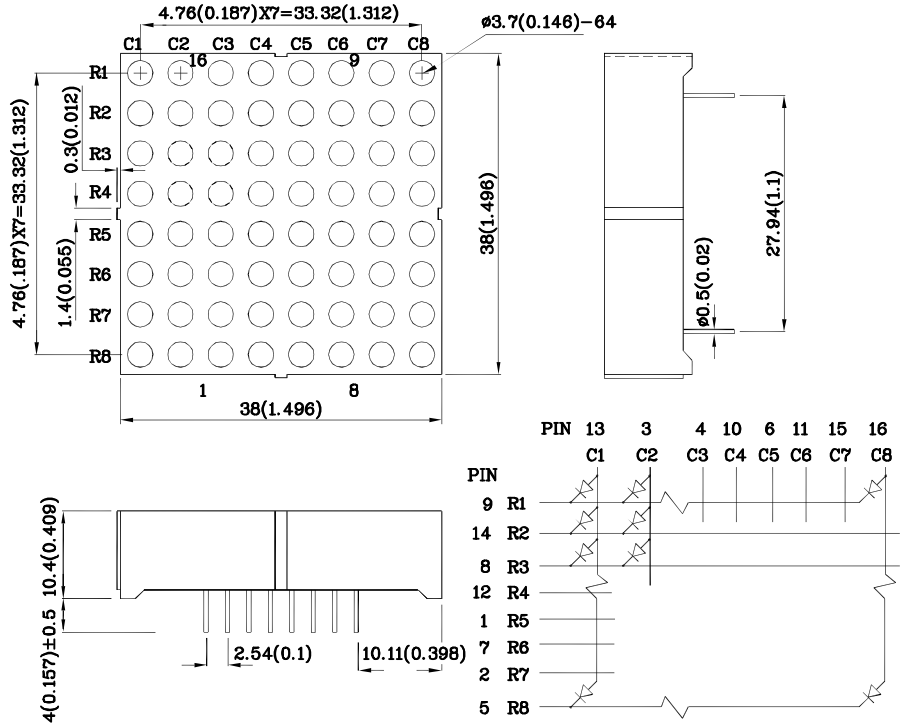

Notes:

1. All dimensions are in millimeters (inches), Tolerance is  $\pm 0.25(0.01)$  unless otherwise noted.
2. Specifications are subject to change without notice.

| Absolute Maximum Ratings<br>( $T_A=25^\circ\text{C}$ )         |                       | UY<br>(GaAsP/GaP) | Unit |
|--|-----------------------|-------------------|------|
| Reverse Voltage  | $V_R$                 | 5                 | V    |
| Forward Current  | $I_F$                 | 30                | mA   |
| Forward Current (Peak)<br>1/10 Duty Cycle<br>0.1ms Pulse Width | $i_{FS}$              | 140               | mA   |
| Power Dissipation  | $P_D$                 | 75                | mW   |
| Operating Temperature  | $T_A$                 | -40 ~ +85         | °C   |
| Storage Temperature  | $T_{stg}$             | -40 ~ +85         |      |
| Lead Solder Temperature<br>[2mm Below Package Base]            | 260°C For 3-5 Seconds |                   |      |

| Operating Characteristics<br>( $T_A=25^\circ\text{C}$ )                     |                 | UY<br>(GaAsP/GaP) | Unit          |
|---|-----------------|-------------------|---------------|
| Forward Voltage (Typ.)<br>( $I_F=10\text{mA}$ )                             | $V_F$           | 1.95              | V             |
| Forward Voltage (Max.)<br>( $I_F=10\text{mA}$ )                             | $V_F$           | 2.5               | V             |
| Reverse Current (Max.)<br>( $V_R=5\text{V}$ )                               | $I_R$           | 10                | $\mu\text{A}$ |
| Wavelength of Peak<br>Emission (Typ.)<br>( $I_F=10\text{mA}$ )              | $\lambda_P$     | 590               | nm            |
| Wavelength of Dominant<br>Emission (Typ.)<br>( $I_F=10\text{mA}$ )          | $\lambda_D$     | 588               | nm            |
| Spectral Line Full Width<br>At Half-Maximum (Typ.)<br>( $I_F=10\text{mA}$ ) | $\Delta\lambda$ | 35                | nm            |
| Capacitance (Typ.)<br>( $V_F=0\text{V}$ , $f=1\text{MHz}$ )                 | C               | 20                | pF            |

| Part Number | Emitting Color | Emitting Material | Luminous Intensity<br>( $I_F=10\text{mA}$ )<br>ucd |      | Wavelength<br>nm<br>$\lambda_P$ | Description  |
|-------------|----------------|-------------------|--|------|---------------------------------|--------------|
|             |                |                   | min.   | typ. |                                 |              |
| MUY38A8     | Yellow         | GaAsP/GaP         | 5600   | 9990 | 590                             | Column Anode |

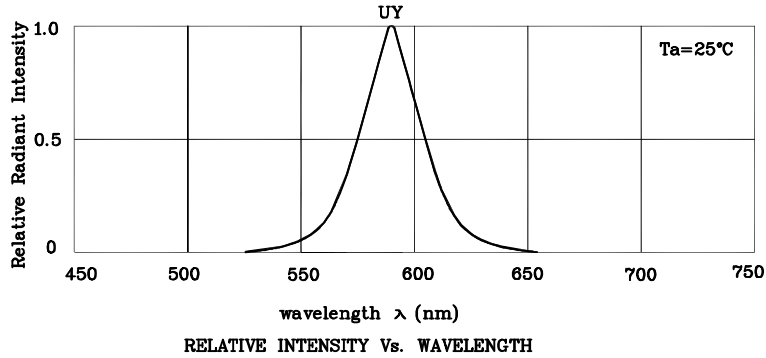

❖ UY

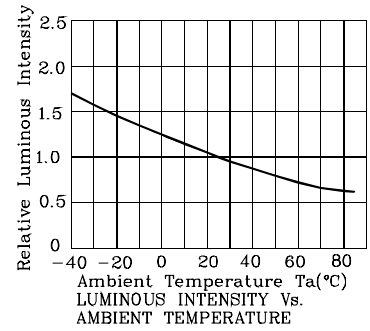
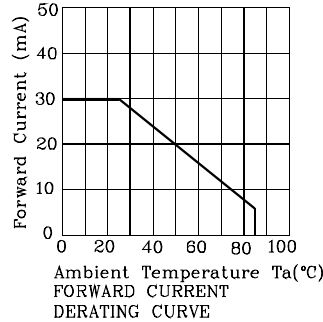
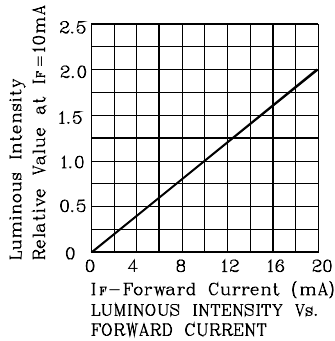
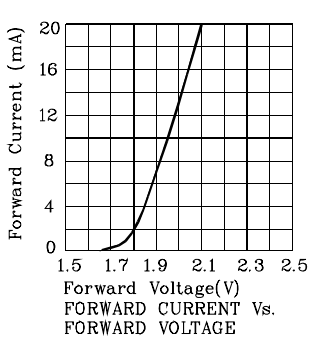

Wave Soldering Profile for Thru-Hole Products (Pb-Free Components)

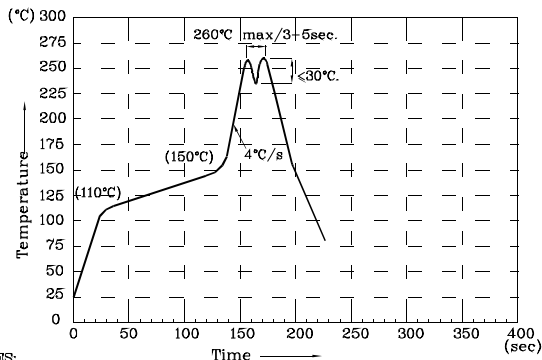

- NOTES:
1. Recommend the wave temperature 245°C~260°C. The maximum soldering temperature should be less than 260°C.
  2. Do not apply stress on epoxy resins when temperature is over 85°C.
  3. The soldering profile apply to the lead free soldering (Sn/Cu/Ag alloy).
  4. During wave soldering, the PCB top-surface temperature should be kept below 105°C.
  5. No more than once.

Remarks:

If special sorting is required (e.g. binning based on forward voltage, luminous intensity / luminous flux, or wavelength), the typical accuracy of the sorting process is as follows:

1. Wavelength: +/-1nm
2. Luminous Intensity / Luminous Flux: +/-15%
3. Forward Voltage: +/-0.1V

Note: Accuracy may depend on the sorting parameters.



PACKING & LABEL SPECIFICATIONS

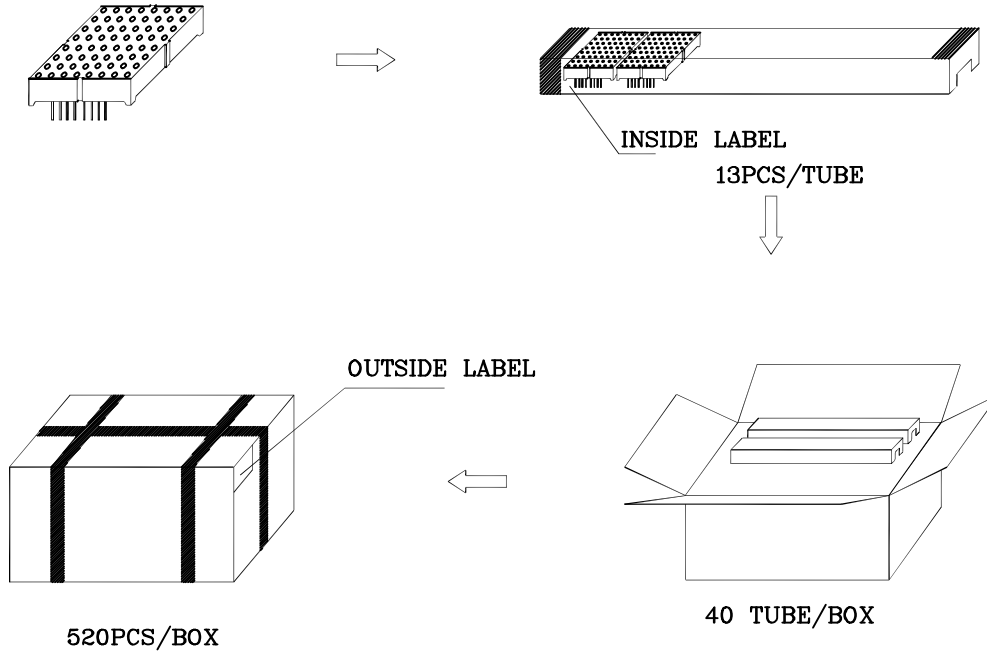

Inside Label On IC-tube

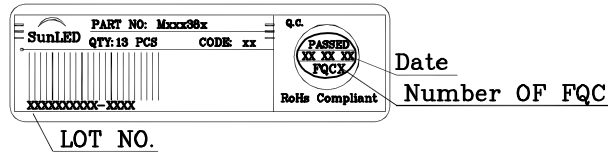

Outside Label On Box

