

ADC10831, ADC10832, ADC10834, ADC10838 10-Bit Plus Sign Serial I/O A/D Converters with MUX, Sample/Hold and Reference

General Description

This series of CMOS 10-bit plus sign successive approximation A/D converters features versatile analog input multiplexers, sample/hold and a 2.5V band-gap reference. The 1, 2, 4 or 8-channel multiplexers can be software configured for single-ended or differential mode of operation.

An input sample/hold is implemented by a capacitive reference ladder and sampled-data comparator. This allows the analog input to vary during the A/D conversion cycle.

In the differential mode, valid outputs are obtained even when the negative inputs are greater than the positive because of the 10-bit plus sign output data format.

The serial I/O is configured to comply with the NSC MICROWIRE™ serial data exchange standard for easy interface to the COPS™ and HPC™ families of controllers, and can easily interface with standard shift registers and microprocessors.

Applications

- Medical instruments
- Remote instrumentation
- Test equipment

Features

- -5V to +5V analog voltage range with ±5V supplies
- Serial I/O (MICROWIRE compatible)
- 1, 2, 4, or 8-channel differential or single-ended multiplexer
- Software or hardware power down
- Analog input sample/hold function
- Ratiometric or Absolute voltage referencing
- No zero or full scale adjustment required.
- No missing codes over temperature
- TTL/MOS input/output compatible
- Standard DIP and SO packages

Key Specifications

- | | |
|----------------------|-------------------|
| ■ Resolution | 10 bits plus sign |
| ■ Dual supply | ±5V |
| ■ Power dissipation | 59 mW (Max) |
| ■ In power down mode | 33 μW |
| ■ Conversion time | 5 μs (Max) |
| ■ Sampling rate | 74 kHz (Max) |
| ■ Band-gap reference | 2.5V ±2% (Max) |

ADC10838 Simplified Block Diagram

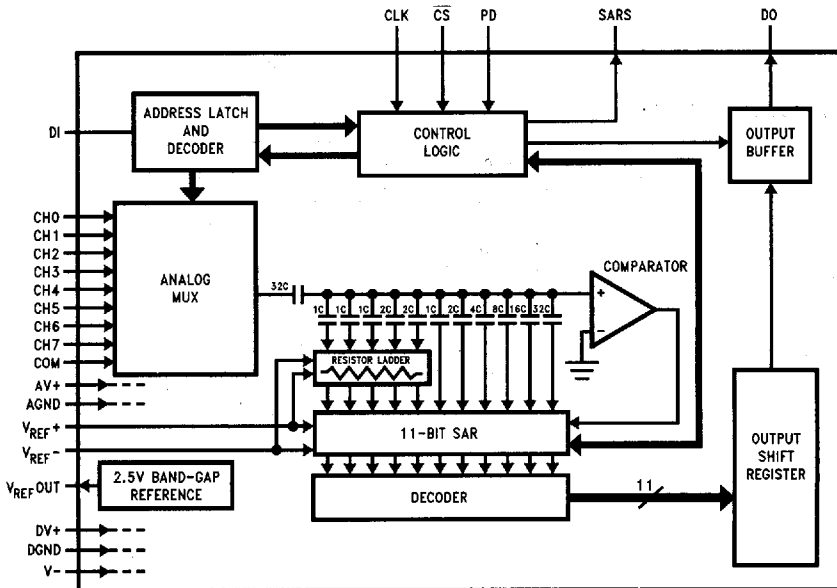

TL/H/11391-1

Connection Diagrams for Dual-In-Line and SO Packages

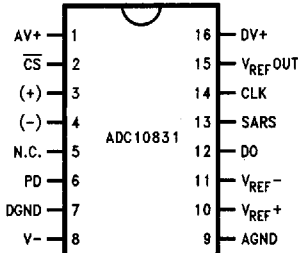

Top View

TL/H/11391-2

See NS Package Number N16E or M16B

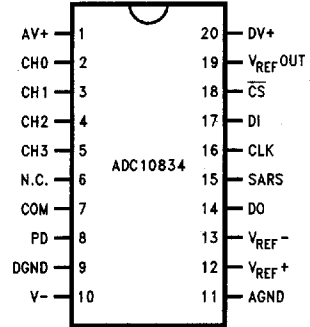

Top View

TL/H/11391-4

See NS Package Number N20A or M20B

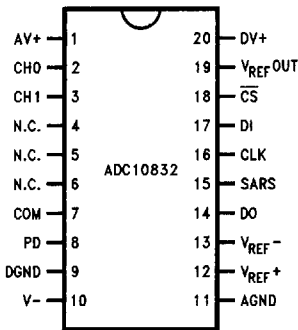

Top View

TL/H/11391-3

See NS Package Number N20A or M20B

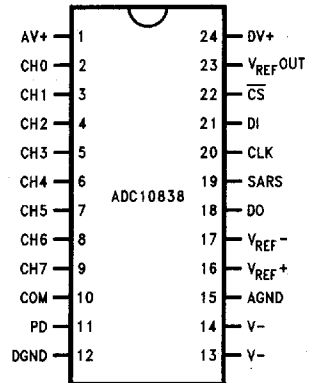

Top View

TL/H/11391-5

See NS Package Number N24A or M24B

Ordering Information

Industrial Temperature Range -40°C ≤ T _A ≤ +85°C	Package
ADC10831CIN	N16E
ADC10831CIWM	M16B
ADC10832CIN	N20A
ADC10832CIWM	M20B
ADC10834CIN	N20A
ADC10834CIWM	M20B
ADC10838CIN	N24A
ADC10838CIWM	M24B

Absolute Maximum Ratings (Notes 1 & 3)

If Military/Aerospace specified devices are required, please contact the National Semiconductor Sales Office/Distributors for availability and specifications.

Positive Supply Voltage ($V^+ = AV^+ = DV^+$)	+6.0V
Negative Supply Voltage (V^-)	-6.0V
Total Supply Voltage ($V^+ - V^-$)	12V
Total Reference Voltage ($V_{REF^+} - V_{REF^-}$)	+6.0V
Voltage at Analog Inputs (CH0-CH7 and COM)	$V^+ + 0.3V$ to $V^- - 0.3V$
Voltage at other Inputs and Outputs	$V^+ + 0.3V$ to $-0.3V$
Input Current at Any Pin (Note 4)	30 mA
Package Input Current (Note 4)	120 mA
Package Dissipation at $T_A = 25^\circ\text{C}$ (Note 5)	500 mW
ESD Susceptibility (Note 6)	
Human Body Model	2500V
Machine Model	150V
Soldering Information	
N packages (10 seconds)	260°C
SO Package (Note 7)	
Vapor Phase (60 seconds)	215°C
Infrared (15 seconds)	220°C

Storage Temperature -40°C to $+150^\circ\text{C}$

Operating Ratings (Notes 2 and 3)

Operating Temperature Range	$T_{MIN} \leq T_A \leq T_{MAX}$
ADC10831CIN, ADC10831CIWM, ADC10832CIN, ADC10832CIWM, ADC10834CIN, ADC10834CIWM, ADC10838CIN, ADC10838CIWM	$-40^\circ\text{C} \leq T_A \leq +85^\circ\text{C}$
Positive Supply Voltage ($V^+ = AV^+ = DV^+$)	+4.5V to +5.5V
Negative Supply Voltage (V^-)	-4.5V to -5.5V
V_{REF^+}	$AV^+ + 50\text{ mV}$ to -50 mV
V_{REF^-}	$AV^+ + 50\text{ mV}$ to -50 mV
V_{REF} ($V_{REF^+} - V_{REF^-}$)	+0.5V to V^+

Electrical Characteristics

The following specifications apply for $V^+ = AV^+ = DV^+ = +5.0\text{ V}_{DC}$, $V_{REF^+} = +4.096\text{ V}_{DC}$, $V_{REF^-} = V_{IN^-} = \text{GND}$, $V^- = -5.0\text{ V}_{DC}$, and $f_{CLK} = 2.5\text{ MHz}$ unless otherwise specified. **Boldface limits apply for $T_A = T_J = T_{MIN}$ to T_{MAX}** ; all other limits $T_A = T_J = +25^\circ\text{C}$. (Notes 8, 9 and 10)

Symbol	Parameter	Conditions	Typical (Note 11)	Limits (Note 12)	Units (Limits)
STATIC CONVERTER CHARACTERISTICS					
	Resolution with No Missing Codes			10 + Sign	Bits
TUE	Total Unadjusted Error (Note 13)			± 2.0	LSB(max)
INL	Positive and Negative Integral Linearity Error			± 1.25	LSB(max)
	Positive and Negative Full-Scale Error			± 1.5	LSB(max)
	Offset Error			± 1.5	LSB(max)
	Power Supply Sensitivity				
	Offset Error	$V^+ = +5.0V \pm 10\%$	± 0.2	± 1.0	LSB(max)
	+ Full-Scale Error	or $V^- = -5.0 \pm 10\%$	± 0.2	± 1.0	LSB(max)
	- Full-Scale Error		± 0.1	± 0.75	LSB(max)
	DC Common Mode Error (Note 14)	$V_{IN^+} = V_{IN^-} = V_{IN}$ where $+5.0V \geq V_{IN} \geq -5V$	± 0.15	± 0.6	LSB(max)
	Multiplexer Channel to Channel Matching		± 0.1		LSB

Electrical Characteristics (Continued)

The following specifications apply for $V^+ = AV^+ = DV^+ = +5.0 V_{DC}$, $V_{REF}^+ = +4.096 V_{DC}$, $V_{REF}^- = V_{IN}^- = GND$, $V^- = -5.0 V_{DC}$, and $f_{CLK} = 2.5 MHz$ unless otherwise specified. **Boldface limits apply for $T_A = T_J = T_{MIN}$ to T_{MAX}** ; all other limits $T_A = T_J = +25^\circ C$. (Notes 8, 9 and 10) (Continued)

Symbol	Parameter	Conditions	Typical (Note 11)	Limits (Note 12)	Units (Limits)
DYNAMIC CONVERTER CHARACTERISTICS					
S/(N + D)	Signal-to-Noise Plus Distortion Ratio	$V_{IN} = 8.0 V_{PP}$, Sampling Rate = 74 kHz and $f_{IN} = 1 kHz$ to 15 kHz	67		dB
ENOB	Effective Number of Bits	$V_{IN} = 8.0 V_{PP}$, Sampling Rate = 74 kHz and $f_{IN} = 1 kHz$ to 15 kHz	10.8		Bits
THD	Total Harmonic Distortion	$V_{IN} = 8.0 V_{PP}$, Sampling Rate = 74 kHz and $f_{IN} = 1 kHz$ to 15 kHz	-78		dB
IMD	Intermodulation Distortion	$V_{IN} = 8.0 V_{PP}$, Sampling Rate = 74 kHz and $f_{IN} = 1 kHz$ to 15 kHz	-85		dB
	Full-Power Bandwidth	$V_{IN} = 8.0 V_{PP}$, where S/(N + D) Decreases 3 dB Sampling Rate = 74 kHz	380		kHz
	Multiplexer Channel to Channel Crosstalk	$f_{IN} = 15 kHz$ Sampling Rate = 74 kHz	-80		dB
REFERENCE INPUT AND MULTIPLEXER CHARACTERISTICS					
	Reference Input Resistance		7	5.0 9.5	k Ω k Ω (min) k Ω (max)
C_{REF}	Reference Input Capacitance		70		pF
	MUX Input Voltage			$V^- - 50 mV$ $AV^+ + 50 mV$	(min) (max)
C_{IM}	MUX Input Capacitance		47		pF
	Off Channel Leakage Current (Note 15)	On Channel = +5V and Off Channel = -5V	-0.4	-3.0	μA (max)
		On Channel = -5V and Off Channel = +5V	0.4	3.0	μA (max)
	On Channel Leakage Current (Note 15)	On Channel = +5V and Off Channel = +5V	0.4	3.0	μA (max)
		On Channel = -5V and Off Channel = +5V	-0.4	-3.0	μA (max)

Electrical Characteristics (Continued)

The following specifications apply for $V^+ = AV^+ = DV^+ = +5.0 V_{DC}$, $V_{REF}^+ = +4.096 V_{DC}$, $V_{REF}^- = V_{IN}^- = GND$, $V^- = -5.0 V_{DC}$, and $f_{CLK} = 2.5 MHz$ unless otherwise specified. **Boldface limits apply for $T_A = T_J = T_{MIN}$ to T_{MAX}** ; all other limits $T_A = T_J = +25^\circ C$. (Notes 8, 9 and 10) (Continued)

Symbol	Parameter	Conditions	Typical (Note 11)	Limits (Note 12)	Units (Limits)
REFERENCE CHARACTERISTICS					
V_{REFOut}	Reference Output Voltage		$2.5V \pm 0.5\%$	$2.5V \pm 2\%$	V(max)
$\Delta V_{REF}/\Delta T$	V_{REFOut} Temperature Coefficient		± 40		ppm/ $^\circ C$
$\Delta V_{REF}/\Delta I_L$	Load Regulation, Sourcing	$0 mA \leq I_L \leq +4 mA$	± 0.003	± 0.05	%/mA(max)
$\Delta V_{REF}/\Delta I_L$	Load Regulation, Sinking	$0 mA \leq I_L \leq -1 mA$	± 0.2	± 0.6	%/mA(max)
	Line Regulation	$5V \pm 10\%$	± 0.3	± 2.5	mV(max)
I_{SC}	Short Circuit Current	$V_{REFOut} = 0V$	13	22	mA(max)
	Noise Voltage	10 Hz to 10 kHz, $C_L = 100 \mu F$	5		μV
$\Delta V_{REF}/\Delta t$	Long-term Stability		± 120		ppm/kHr
t_{SU}	Start-Up Time	$C_L = 100 \mu F$	100		ms
DIGITAL AND DC CHARACTERISTICS					
$V_{IN(1)}$	Logical "1" Input Voltage	$V^+ = 5.5V$		2.0	V(min)
$V_{IN(0)}$	Logical "0" Input Voltage	$V^+ = 4.5V$		0.8	V(max)
$I_{IN(1)}$	Logical "1" Input Current	$V_{IN} = 5.0V$	0.005	+ 2.5	μA (max)
$I_{IN(0)}$	Logical "0" Input Current	$V_{IN} = 0V$	-0.005	- 2.5	μA (min)
$V_{OUT(1)}$	Logical "1" Output Voltage	$V^+ = 4.5V, I_{OUT} = -360 \mu A$ $V^+ = 4.5V, I_{OUT} = -10 \mu A$		2.4 4.5	V(min) V(min)
$V_{OUT(0)}$	Logical "0" Output Voltage	$V^+ = 4.5V, I_{OUT} = 1.6 mA$		0.4	V(min)
I_{OUT}	TRI-STATE Output Current	$V_{OUT} = 0V$ $V_{OUT} = 5V$	-0.1 +0.1	- 3.0 + 3.0	μA (min) μA (max)
+ I_{SC}	Output Short-Circuit Source Current	$V_{OUT} = 0V, V^+ = 4.5V$	-30	- 15	mA(max)
- I_{SC}	Output Short-Circuit Sink Current	$V_{OUT} = V^+ = 4.5V$	30	15	mA(min)
I_D^+	Digital Supply Current (Note 17)	$\overline{CS} = HIGH$, Power Up $\overline{CS} = HIGH$, Power Down $\overline{CS} = HIGH$, Power Down, and CLK Off	0.9 0.2 0.5	1.3 0.4 50	mA(max) mA(max) μA (max)
I_A^+	Positive Analog Supply Current (Note 17)	$\overline{CS} = HIGH$, Power Up $\overline{CS} = HIGH$, Power Down	2.7 3.0	6.0 15	mA(max) μA (max)
I_A^-	Negative Analog Supply Current (Note 17)	$\overline{CS} = HIGH$, Power Up $\overline{CS} = HIGH$, Power Down	-2.7 -3.0	-4.5 -15	mA(min) μA (min)
I_{REF}	Reference Input Current	$V_{REF}^+ = +2.5V$ and $\overline{CS} = HIGH$, Power Up		0.6	mA(max)

Electrical Characteristics (Continued)

The following specifications apply for $V^+ = AV^+ = DV^+ = +5.0 V_{DC}$, $V_{REF}^+ = +4.096 V_{DC}$, $V_{REF}^- = V_{IN} = GND$, $V^- = -5.0 V_{DC}$, and $f_{CLK} = 2.5 \text{ MHz}$ unless otherwise specified. **Boldface limits apply for $T_A = T_J = T_{MIN}$ to T_{MAX}** ; all other limits $T_A = T_J = +25^\circ\text{C}$. (Note 16)

Symbol	Parameter	Conditions	Typical (Note 11)	Limits (Note 12)	Units (Limits)
AC CHARACTERISTICS					
f_{CLK}	Clock Frequency		3.0 5	2.5	MHz(max) kHz(min)
	Clock Duty Cycle			40 60	%(min) %(max)
t_C	Conversion Time		12 5	12 5	Clock Cycles $\mu\text{s(max)}$
t_A	Acquisition Time		4.5 2	4.5 2	Clock Cycles $\mu\text{s(max)}$
t_{SCS}	\overline{CS} Set-Up Time, Set-Up Time from Falling Edge of \overline{CS} to Rising Edge of Clock		14 (1 t_{CLK} - 14 ns)	30 (1 t_{CLK} - 30 ns)	ns(min) (max)
t_{SDI}	DI Set-Up Time, Set-Up Time from Data Valid on DI to Rising Edge of Clock		16	25	ns(min)
t_{HDI}	DI Hold Time, Hold Time of DI Data from Rising Edge of Clock to Data not Valid on DI		2	25	ns(min)
t_{AT}	DO Access Time from Rising Edge of CLK When \overline{CS} is "Low" during a Conversion		30	50	ns(min)
t_{AC}	DO or SARS Access Time from \overline{CS} , Delay from Falling Edge of \overline{CS} to Data Valid on DO or SARS		30	70	ns(max)
t_{DSARS}	Delay from Rising Edge of Clock to Falling Edge of SARS when \overline{CS} is "Low"		100	200	ns(max)
t_{HDO}	DO Hold Time, Hold Time of Data on DO after Falling Edge of Clock		20	45	ns(max)
t_{AD}	DO Access Time from Clock, Delay from Falling Edge of Clock to Valid Data of DO		40	80	ns(max)
t_{1H}, t_{0H}	Delay from Rising Edge of \overline{CS} to DO or SARS TRI-STATE		40	50	ns(max)
t_{DCS}	Delay from Falling Edge of Clock to Falling Edge of \overline{CS}		20	30	ns(min)
$t_{CS(H)}$	\overline{CS} "HIGH" Time for A/D Reset after Reading of Conversion Result		1 CLK	1 CLK	cycle(min)
$t_{CS(L)}$	ADC10731 Minimum \overline{CS} "Low" Time to Start a Conversion		1 CLK	1 CLK	cycle(min)
t_{SC}	Time from End of Conversion to \overline{CS} Going "Low"		5 CLK	5 CLK	cycle(min)
t_{PD}	Delay from Power-Down command to 10% of Operating Current		1		μs
t_{PC}	Delay from Power-Up Command to Ready to Start a New Conversion		10		μs
C_{IN}	Capacitance of Logic Inputs		7		pF
C_{OUT}	Capacitance of Logic Outputs		12		pF

Electrical Characteristics (Continued)

Note 1: Absolute Maximum Ratings indicate limits beyond which damage to the device may occur.

Note 2: Operating Ratings indicate conditions for which the device is functional, but do not guarantee specific performance limits. For guaranteed specifications and test conditions, see the Electrical Characteristics. The guaranteed specifications apply only for the test conditions listed. Some performance characteristics may degrade when the device is not operated under the listed test conditions.

Note 3: All voltages are measured with respect to GND, unless otherwise specified.

Note 4: When the input voltage (V_{IN}) at any pin exceeds the power supplies ($V_{IN} < V^-$ or $V_{IN} > AV^+$ or DV^+), the current at that pin should be limited to 30 mA. The 120 mA maximum package input current rating limits the number of pins that can safely exceed the power supplies with an input current of 30 mA to four.

Note 5: The maximum power dissipation must be derated at elevated temperatures and is dictated by T_{Jmax} , θ_{JA} and the ambient temperature, T_A . The maximum allowable power dissipation at any temperature is $P_D = (T_{Jmax} - T_A)/\theta_{JA}$ or the number given in the Absolute Maximum Ratings, whichever is lower. For this device, $T_{Jmax} = 150^\circ\text{C}$. The typical thermal resistance (θ_{JA}) of these Parts when board mounted can be found in the following table:

Part Number	Thermal Resistance	Package Type
ADC10831CIN	82°C/W	N16E
ADC10831CIWM	90°C/W	M16B
ADC10832CIN	47°C/W	N20A
ADC10832CIWM	80°C/W	M20B
ADC10834CIN	47°C/W	N20A
ADC10834CIWM	80°C/W	M20B
ADC10838CIN	60°C/W	N24A
ADC10838CIWM	75°C/W	M24B

Note 6: The human body model is a 100 pF capacitor discharged through a 1.5 k Ω resistor into each pin. The machine model is a 200 pF capacitor discharged directly into each pin.

Note 7: See AN-450 "Surface Mounting Methods and Their Effect on Product Reliability" or the section titled "Surface Mount" found in any post 1986 National Semiconductor Linear Data Book for other methods of soldering surface mount devices.

Note 8: Two on-chip diodes are tied to each analog input as shown below. They will forward-conduct for analog input voltages one diode drop below V^- or one diode drop greater than V^+ supply. Be careful during testing at low V^+ and V^- levels ($\pm 4.5\text{V}$), as high level analog inputs ($\pm 5\text{V}$) can cause an input diode to conduct, especially at elevated temperatures, which will cause errors in the conversion result. The specification allows 50 mV forward bias of either diode; this means that as long as the analog V_{IN} does not exceed the supply voltage by more than 50 mV, the output code will be correct. Exceeding this range on an unselected channel will corrupt the reading of a selected channel. If AV^+ and DV^+ are minimum ($4.5 V_{DC}$) and V^- is a maximum ($-4.5 V_{DC}$) full scale must be $\leq \pm 4.55 V_{DC}$.

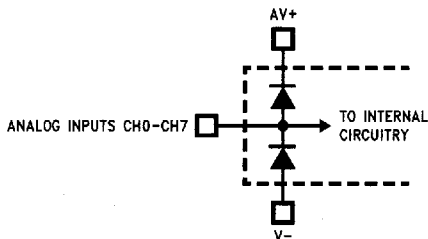

Note 9: No connection exists between AV^+ and DV^+ on the chip.

To guarantee accuracy, it is required that the AV^+ and DV^+ be connected together to a power supply with separate bypass filter at each V^+ pin.

Note 10: One LSB is referenced to 10 bits of resolution.

Note 11: Typicals are at $T_J = T_A = 25^\circ\text{C}$ and represent most likely parametric norm.

Note 12: Tested limits are guaranteed to National's AOQL (Average Outgoing Quality Level).

Note 13: Total unadjusted error includes offset, full-scale, linearity, multiplexer, and hold step errors.

Note 14: The DC common-mode error is measured in the differential multiplexer mode with the assigned positive and negative input channels shorted together.

Note 15: Channel leakage current is measured after the channel selection.

Note 16: All the timing specifications are tested at the TTL logic levels, $V_{IL} = 0.8\text{V}$ for a falling edge and $V_{IH} = 2.0\text{V}$ for a rising. TRI-STATE voltage level is forced to 1.4V.

Note 17: The voltage applied to the digital inputs will affect the current drain during power down. These devices are tested with CMOS logic levels (logic Low = 0V and logic High = 5V). TTL levels increase the power down current to about 300 μA .

Electrical Characteristics (Continued)

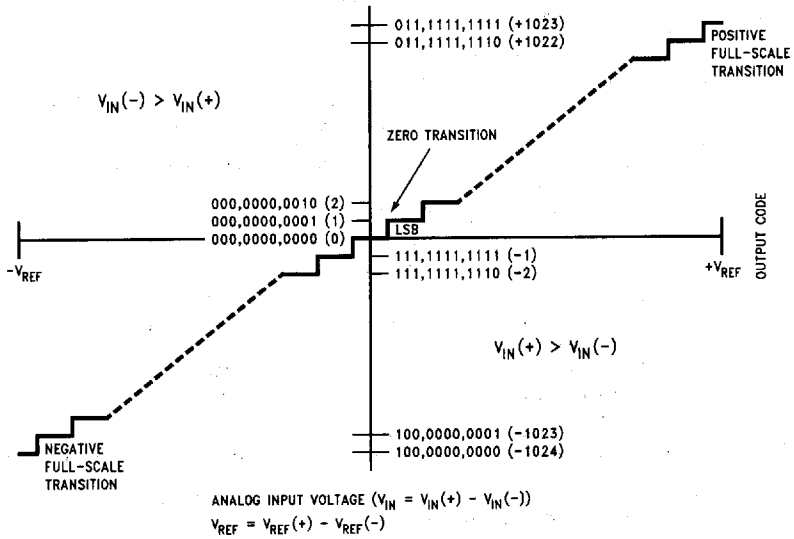

TL/H/11391-7

FIGURE 1A. Transfer Characteristic

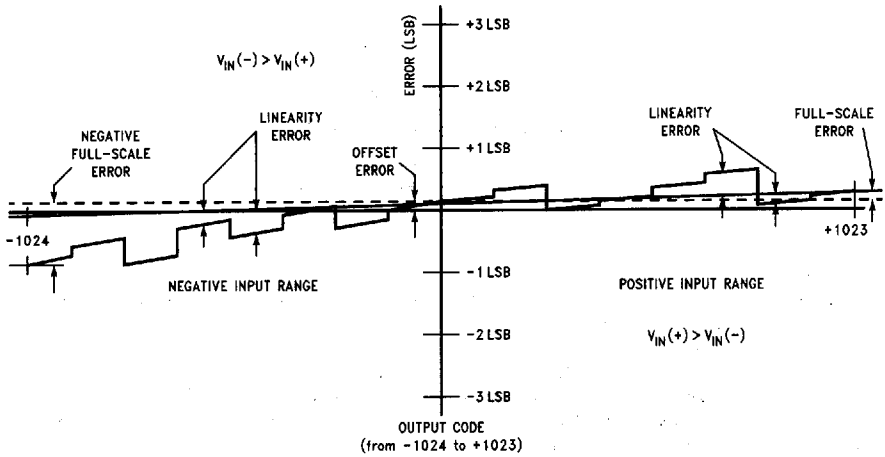

TL/H/11391-8

FIGURE 1B. Simplified Error Curve vs Output Code

Leakage Current Test Circuit

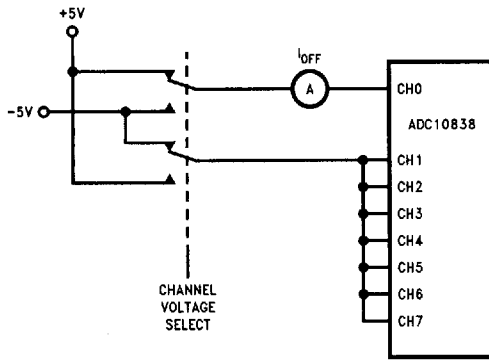

TL/H/11391-9

Typical Performance Characteristics

Analog Supply Current (I_A^+) vs Temperature

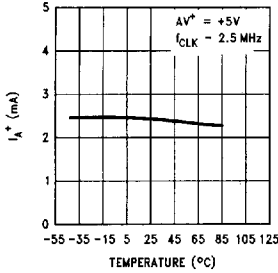

Analog Supply Current (I_A^+) vs Clock Frequency

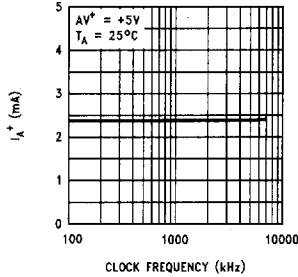

Digital Supply Current (I_D^+) vs Temperature

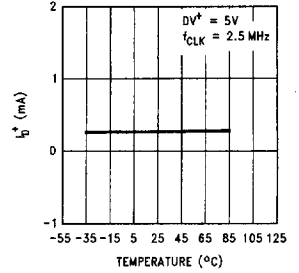

Digital Supply Current (I_D^+) vs Clock Frequency

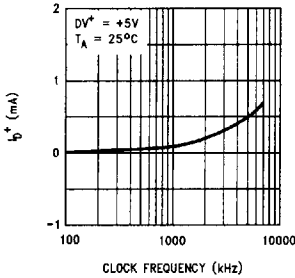

Offset Error vs Reference Voltage

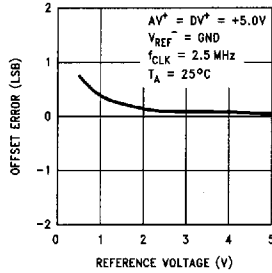

Offset Error vs Temperature

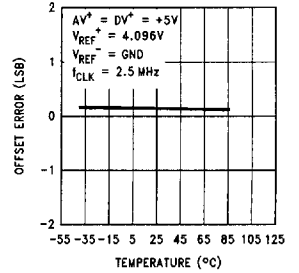

Linearity Error vs Clock Frequency

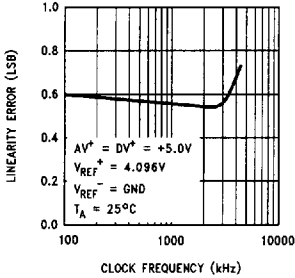

Linearity Error vs Reference Voltage

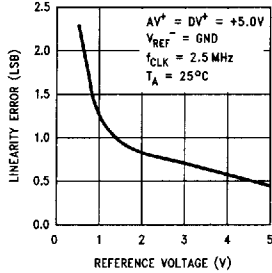

Linearity Error vs Temperature

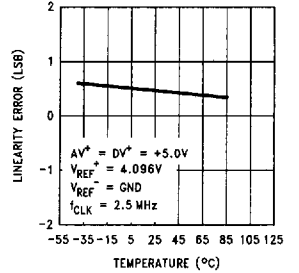

10-Bit Unsigned Signal-to-Noise + THD Ratio vs Input Signal Level

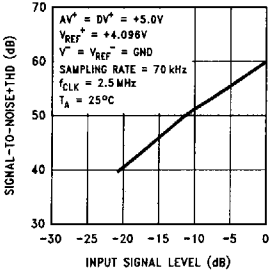

Spectral Response with 34 kHz Sine Wave

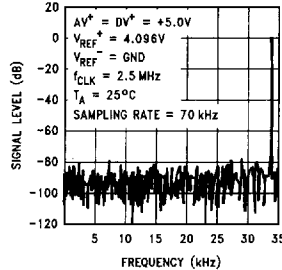

Power Bandwidth Response with 380 kHz Sine Wave

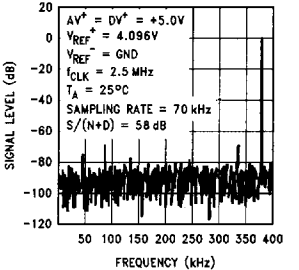

TL/H/11381-10

Typical Reference Performance Characteristics

ADC10831, ADC10832, ADC10834, ADC10838

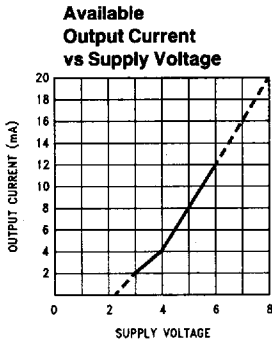
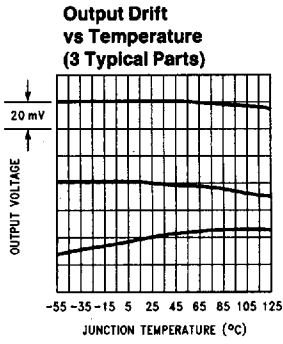
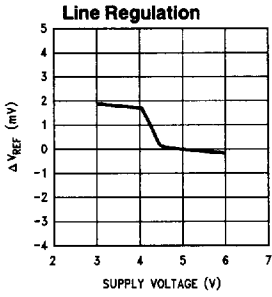
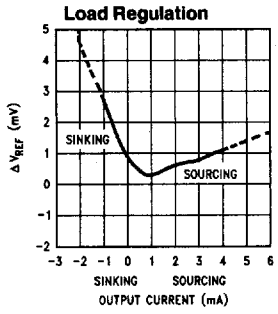

TL/H/11391-11

TRI-STATE Test Circuits and Waveforms

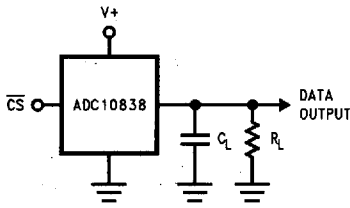

TL/H/11391-12

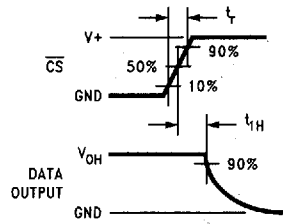

TL/H/11391-13

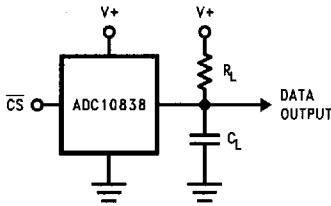

TL/H/11391-14

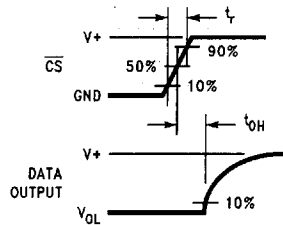

TL/H/11391-15

Timing Diagrams

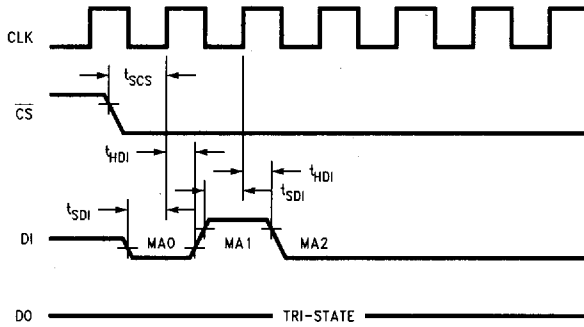

TL/H/11391-16

FIGURE 2. DI Timing

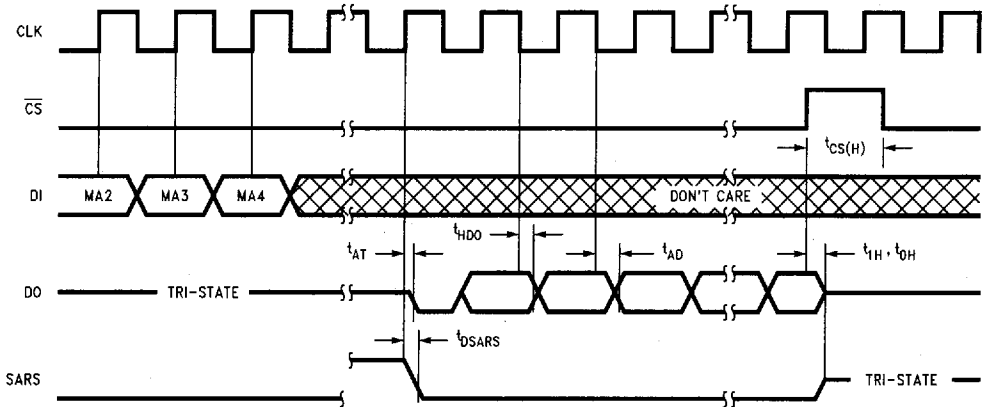

TL/H/11391-17

FIGURE 3. DO Timing

Timing Diagrams (Continued)

ADC10831, ADC10832, ADC10834, ADC10838

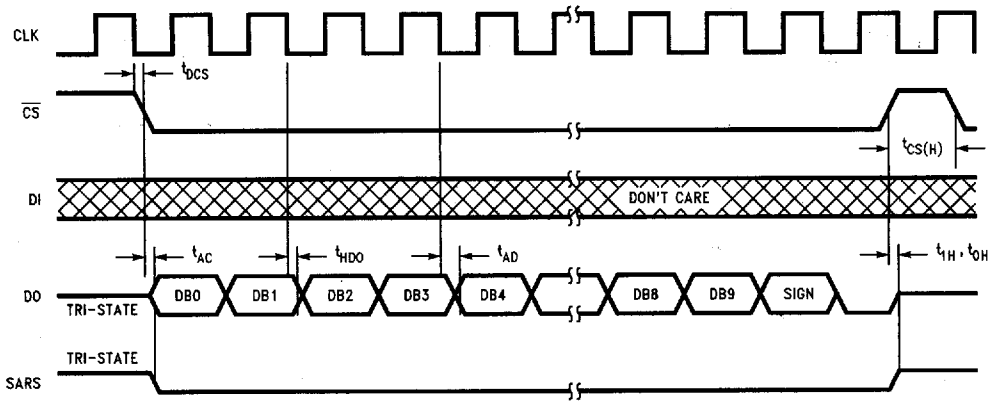

FIGURE 4. Delayed DO Timing

TL/H/11391-18

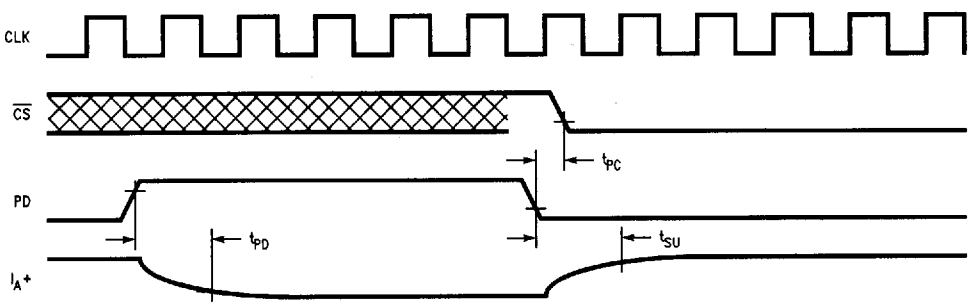

FIGURE 5. Hardware Power Up/Down Sequence

TL/H/11391-19

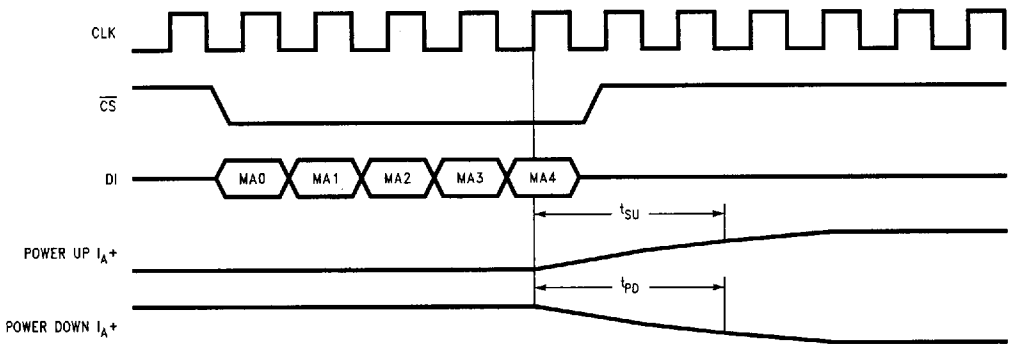
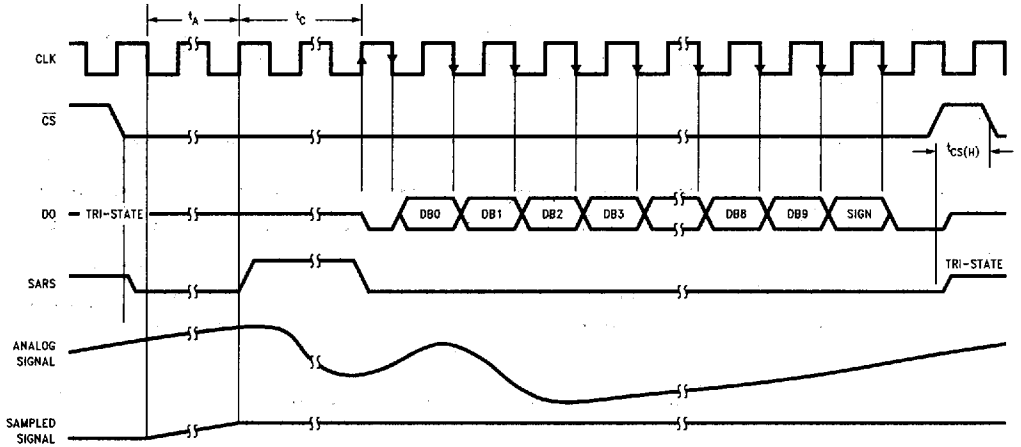

FIGURE 6. Software Power Up/Down Sequence

TL/H/11391-20

2

Timing Diagrams (Continued)



TL/H/11391-21

Note: If \overline{CS} is low during power up of the power supply voltages (AV^+ and DV^+) then \overline{CS} needs to go high for $t_{CS(H)}$. The data output after the first conversion is invalid.

FIGURE 7. ADC10831 \overline{CS} Low during Conversion

Timing Diagrams (Continued)

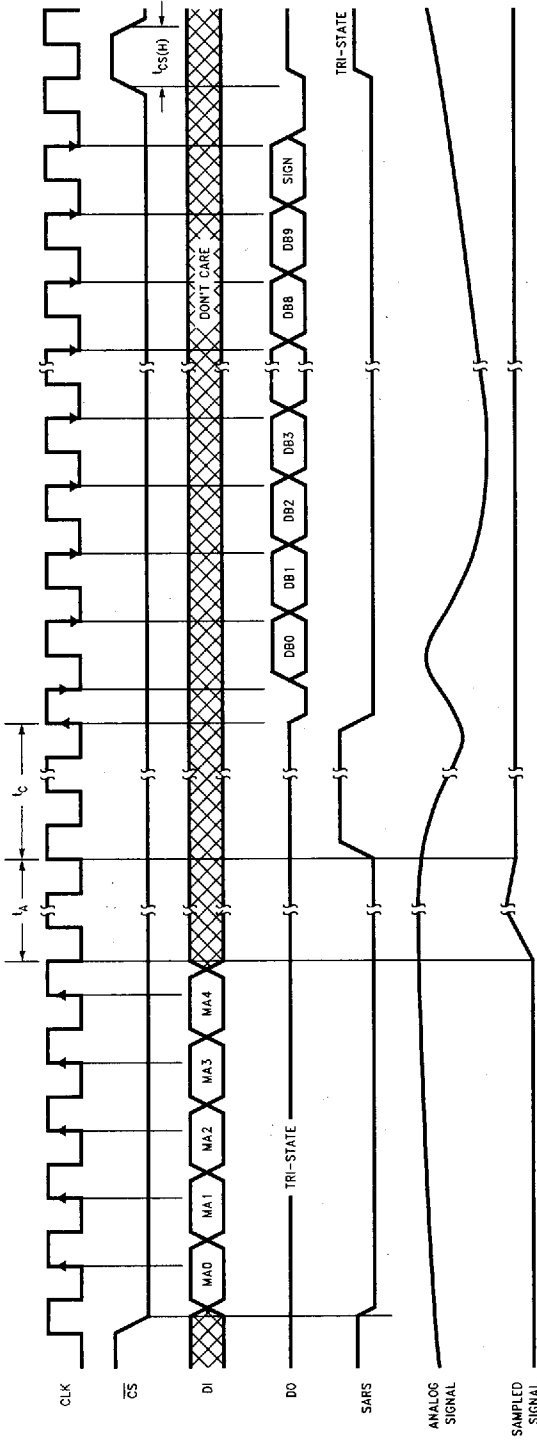

TL/H/11391-22

FIGURE 8. ADC10832, ADC10834 and ADC10838 CS Low during Conversion

Note: If CS is low during power up of the power supply voltages (AV+ and DV+) then CS needs to go high for t_{cSH} then CS needs to go low for t_{cSL} . The data output after the first conversion is not valid.

Timing Diagrams (Continued)

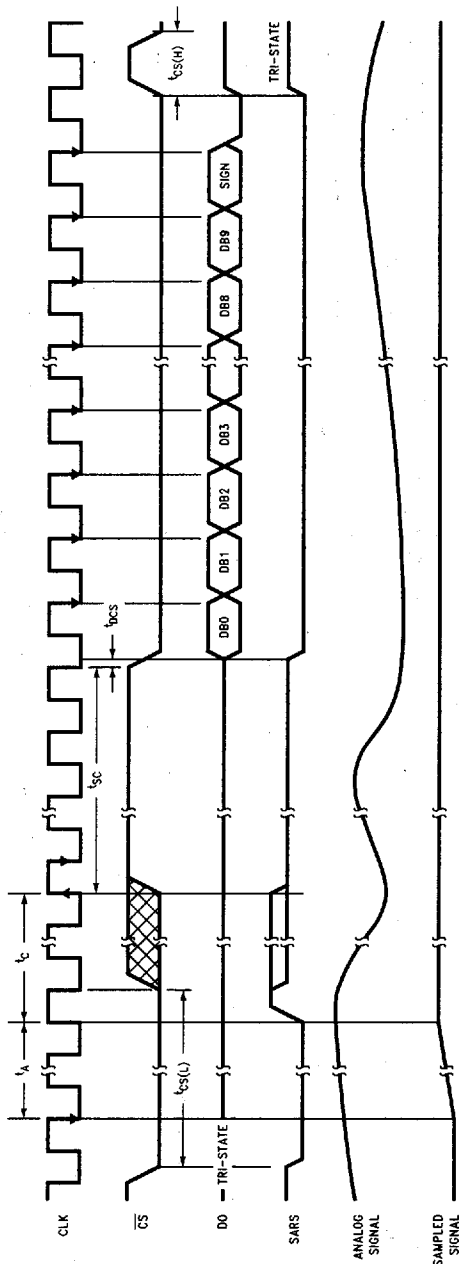

TL/H/11991-23

FIGURE 9. ADC10831 Using \overline{CS} to Delay Output of Data after a Conversion has Completed
 Note: If \overline{CS} is low during power up of the power supply voltages (AV^+ and DV^+) then \overline{CS} needs to go high for $t_{cs(H)}$. The data output after the first conversion is not valid.

Timing Diagrams (Continued)

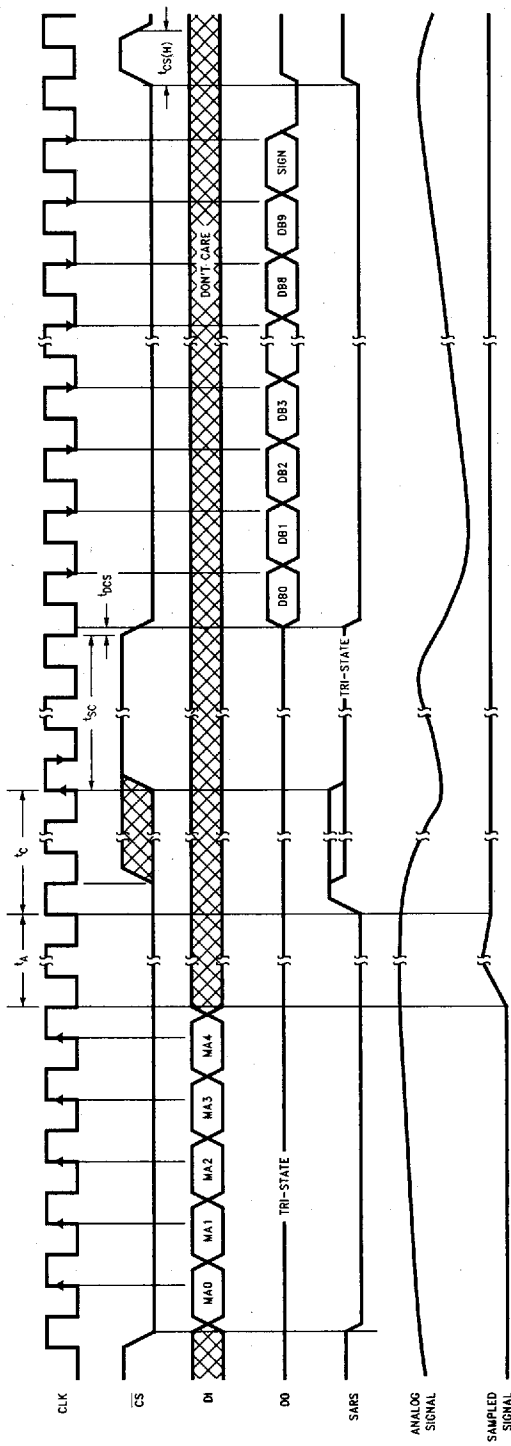

TU/H/11991-24

FIGURE 10. ADC10832, ADC10834 and ADC10838 Using CS to Delay Output of Data after a Conversion has Completed
 Note: If CS is low during power up of the power supply voltages (AV+ and DV+), then CS needs to go high for $t_{cs(H)}$. The data output after the first conversion is not valid.

TABLE I. ADC10838 Multiplexer Address Assignment

MUX Address					Channel Number									MUX MODE
MA0	MA1	MA2	MA3	MA4	CH0	CH1	CH2	CH3	CH4	CH5	CH6	CH7	COM	
PU	SING/ DIFF	ODD/ SIGN	SEL1	SEL0										
1	1	0	0	0	+								-	Single-Ended
1	1	0	0	1			+						-	
1	1	0	1	0					+				-	
1	1	0	1	1							+		-	
1	1	1	0	0		+						+	-	
1	1	1	0	1				+					-	
1	1	1	1	0						+			-	
1	1	1	1	1								+	-	
1	0	0	0	0	+	-								Differential
1	0	0	0	1			+	-						
1	0	0	1	0					+	-				
1	0	0	1	1							+	-		
1	0	1	0	0	-	+								
1	0	1	0	1			-	+						
1	0	1	1	0					-	+				
1	0	1	1	1							-	+		
0	X	X	X	X	Power Down (All Channels Disconnected)									

TABLE II. ADC10834 Multiplexer Address Assignment

MUX Address					Channel Number					MUX MODE	
MA0	MA1	MA2	MA3	MA4	CH0	CH1	CH2	CH3	COM		
PU	SING/ DIFF	ODD/ SIGN	SEL1	SEL0							
1	1	0	0	0	+					-	Single-Ended
1	1	0	0	1			+			-	
1	1	1	0	0				+		-	
1	1	1	0	1					+	-	
1	0	0	0	0	+	-					Differential
1	0	0	0	1			+	-			
1	0	1	0	0	-	+					
1	0	1	0	1				-	+		
0	X	X	X	X	Power Down (All Channels Disconnected)						

TABLE III. ADC10832 Multiplexer Address Assignment

MUX Address					Channel Number			MUX MODE	
MA0	MA1	MA2	MA3	MA4	CH0	CH1	COM		
PU	SING/ DIFF	ODD/ SIGN	SEL1	SEL0					
1	1	0	0	0	+			-	Single-Ended
1	1	1	0	0			+	-	
1	0	0	0	0	+	-			Differential
1	0	1	0	0	-	+			
0	X	X	X	X	Power Down (All Channels Disconnected)				

Pin Descriptions

CLK	The clock applied to this input controls the successive approximation conversion time interval, the acquisition time and the rate at which the serial data exchange occurs. The rising edge loads the information on the DI pin into the multiplexer address shift register. This address controls which channel of the analog input multiplexer (MUX) is selected. The falling edge shifts the data resulting from the A/D conversion out on DO. \overline{CS} enables or disables the above functions. The clock frequency applied to this input can be between 5 kHz and 3 MHz.	CH0-CH7	These are the analog inputs of the MUX. A channel input is selected by the address information at the DI pin, which is loaded on the rising edge of CLK into the address register (see Tables I-III). The voltage applied to these inputs should not exceed AV^+ or go below V^- by more than 50 mV. Exceeding this range on an unselected channel will corrupt the reading of a selected channel.
DI	This is the serial data input pin. The data applied to this pin is shifted by CLK into the multiplexer address register. Tables I through III show the multiplexer address assignment.	COM	This pin is another analog input. When the analog multiplexer is single ended this input serves as the zero reference level for inputs CH0-CH7 (see Tables I-III). COM can serve as a "pseudo ground" that has an input voltage range of $AV^+ + 50\text{ mV}$ to $V^- - 50\text{ mV}$. In most cases, COM will be grounded. When the MUX is set in the differential pairs mode, COM is not used and may be grounded.
DO	The data output pin. The A/D conversion result (DB0-SIGN) are clocked out by the falling edge of CLK on this pin.	V_{REF}^+	This is the positive analog voltage reference input. In order to maintain accuracy, the voltage range V_{REF} ($V_{REF} = V_{REF}^+ - V_{REF}^-$) is $0.5 V_{DC}$ to $5.0 V_{DC}$ and the voltage at V_{REF}^+ cannot exceed $AV^+ + 50\text{ mV}$.
\overline{CS}	This is the chip select input pin. When a logic low is applied to this pin, the rising edge of CLK shifts the data on DI into the address register. This low also brings DO out of TRI-STATE after a conversion has been completed.	V_{REF}^-	The negative voltage reference input. In order to maintain accuracy, the voltage at this pin must not go below $GND - 50\text{ mV}$ or exceed $AV^+ + 50\text{ mV}$. V_{REF}^- must always be less than V_{REF}^+ .
PD	This is the power down input pin. When a logic high is applied to this pin the A/D is powered down. When a low is applied the A/D is powered up.	AV^+ , DV^+	These are the analog and digital positive power supply pins. These pins should be tied to the same power supply and bypassed separately. The operating voltage range of AV^+ and DV^+ is $4.5 V_{DC}$ to $5.5 V_{DC}$.
SARS	This is the successive approximation register status output pin. When \overline{CS} is high this pin is in TRI-STATE. With \overline{CS} low this pin is active high when a conversion is in progress and active low at all other times.	V^-	This is the negative analog supply pin. The operating voltage range of V^- is $-4.5V$ to $-5.5V$. This supply pin needs to be bypassed with $0.1\ \mu\text{F}$ ceramic and $10\ \mu\text{F}$ tantalum capacitors to the system analog ground.
		DGND	This is the digital ground pin.
		AGND	This is the analog ground pin.

Applications Hints

The ADC10831/2/4/8 use successive approximation to digitize an analog input voltage. The DAC portion of the A/D converters uses a capacitive array and a resistive ladder structure. The structure of the DAC allows a very simple switching scheme to provide a versatile analog input multiplexer. This structure also provides a sample/hold. The ADC10831/2/4/8 have a 2.5V CMOS bandgap reference. The serial digital I/O interfaces to MICROWIRE and MICROWIRE+.

1.0 DIGITAL INTERFACE

There are two modes of operation. The fastest throughput rate is obtained when \overline{CS} is kept low during a conversion. The timing diagrams in *Figures 7* and *8* show the operation of the devices in this mode. \overline{CS} must be taken high for at least $t_{CS(H)}$ (1 CLK) between conversions. This is necessary to reset the internal logic. *Figures 9* and *10* show the operation of the devices when \overline{CS} is taken high while the ADC10831/2/4/8 is converting. \overline{CS} may be taken high during the conversion and kept high indefinitely to delay the output data. This mode simplifies the interface to other devices while the ADC10831/2/4/8 is busy converting.

1.1 Getting Started with a Conversion

The ADC10831/2/4/8 need to be initialized after the power supply voltage is applied. If \overline{CS} is low when the supply voltage is applied then \overline{CS} needs to be taken high for at least $t_{CS(H)}$ (1 clock period). The data output after the first conversion is not valid.

1.2 Software and Hardware Power Up/Down

These devices have the capability of software or hardware power down. *Figures 5* and *6* show the timing diagrams for hardware and software power up/down. In the case of hardware power down note that \overline{CS} needs to be high for t_{PC} after PD is taken low. When PD is high the device is powered down. The total quiescent current, when powered down, is typically 200 μA with the clock at 2.5 MHz and 3 μA with the clock off. The actual voltage level applied to a digital input will affect the power consumption of the

device during power down. CMOS logic levels will give the least amount of current drain (3 μA). TTL logic levels will increase the total power down current drain to 300 μA .

These devices have resistive reference ladders which draw 600 μA with a 2.5V reference voltage. The internal band gap reference voltage shuts down when power down is activated. If an external reference voltage is used, it will have to be shut down to minimize the total current drain of the device.

2.0 ARCHITECTURE

Before a conversion is started, during the analog input sampling period, (t_A), the sampled data comparator is zeroed. As the comparator is being zeroed the channel assigned to be the positive input is connected to the A/D's input capacitor. (The assignment procedure is explained in the Pin Descriptions section.) This charges the input 32C capacitor of the DAC to the positive analog input voltage. The switches shown in the DAC portion of *Figure 11* are set for this zeroing/acquisition period. The voltage at the input and output of the comparator are at equilibrium at this time. When the conversion is started, the comparator feedback switches are opened and the 32C input capacitor is then switched to the assigned negative input voltage. When the comparator feedback switch opens, a fixed amount of charge is trapped on the common plates of the capacitors. The voltage at the input of the comparator moves away from equilibrium when the 32C capacitor is switched to the assigned negative input voltage, causing the output of the comparator to go high ("1") or low ("0"). The SAR next goes through an algorithm, controlled by the output state of the comparator, that redistributes the charge on the capacitor array by switching the voltage on one side of the capacitors in the array. The objective of the SAR algorithm is to return the voltage at the input of the comparator as close as possible to equilibrium. The switch position information at the completion of the successive approximation routine is a direct representation of the digital output. This data is then available to be shifted on the D0 pin.

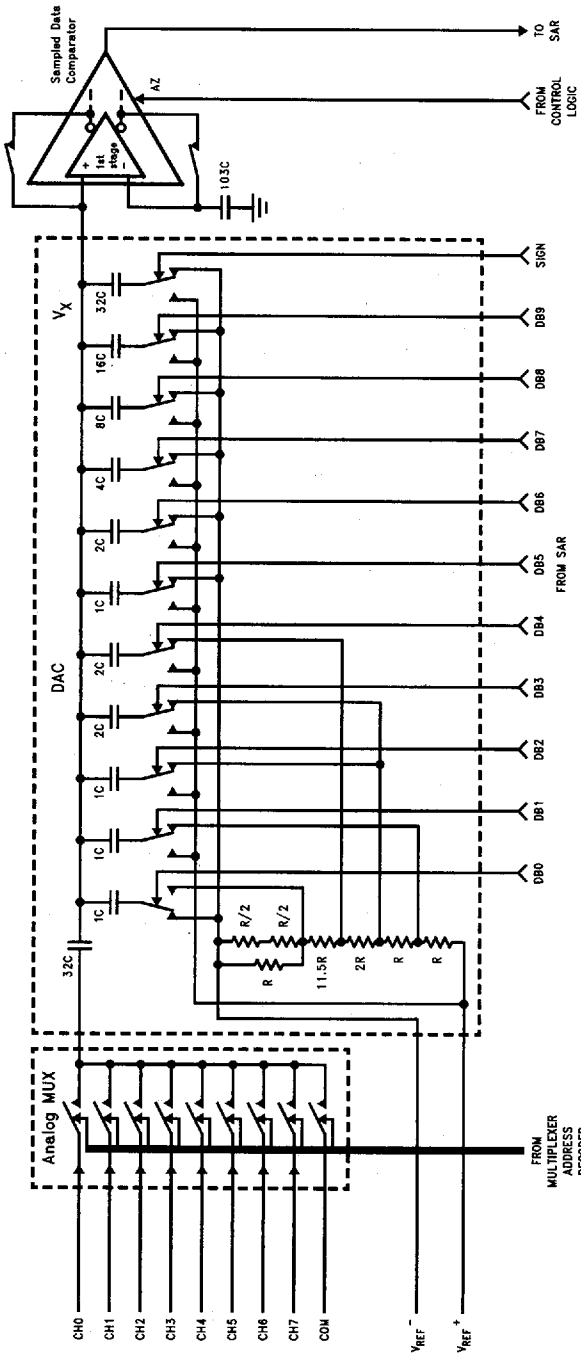

TL/H/11991-25

FIGURE 11. Detailed Diagram of the ADC10838 DAC and Analog Multiplexer Stages

Applications Hints (Continued)

3.0 APPLICATIONS INFORMATION

3.1 Multiplexer Configuration

The design of these converters utilizes a sampled-data comparator structure, which allows a differential analog input to be converted by the successive approximation routine.

The actual voltage converted is always the difference between an assigned "+" input terminal and a "-" input terminal. The polarity of each input terminal or pair of input terminals being converted indicates which line the converter expects to be the most positive.

A unique input multiplexing scheme has been utilized to provide multiple analog channels. The input channels can be software configured into three modes: differential, single-ended, or pseudo-differential. Figure 12 illustrates the three modes using the 4-channel MUX of the ADC10834. The eight inputs of the ADC10838 can also be configured in any of the three modes. The single-ended mode has CH0-CH3 assigned as the positive input with COM serving as the negative input. In the differential mode, the ADC10834 channel inputs are grouped in pairs, CH0 with CH1 and CH2 with CH3. The polarity assignment of each channel in the pair is interchangeable. Finally, in the pseudo-differential mode CH0-CH3 are positive inputs referred to COM which is now a pseudo-ground. This pseudo-ground input can be set to any potential within the input common-mode range of the converter. The analog signal conditioning required in transducer-based data acquisition systems is significantly simplified with this type of input flexibility. One converter package can now handle ground-referred inputs and true differential inputs as well as signals referred to a specific voltage.

The analog input voltages for each channel can range from 50 mV below V^- to 50 mV above $V^+ = DV^+ = AV^+$ without degrading conversion accuracy. If the voltage on an unselected channel exceeds these limits it may corrupt the reading of the selected channel.

3.2 Reference Considerations

The voltage difference between the V_{REF}^+ and V_{REF}^- inputs defines the analog input voltage span (the difference between $V_{IN}(\text{Max})$ and $V_{IN}(\text{Min})$) over which 1023 positive and 1024 negative possible output codes apply.

The value of the voltage on the V_{REF}^+ or V_{REF}^- inputs can be anywhere between $AV^+ + 50$ mV and GND - 50 mV, so long as V_{REF}^+ is greater than V_{REF}^- . The ADC10831/2/4/8 can be used in either ratiometric applications or in systems requiring absolute accuracy. The reference pins must be connected to a voltage source capable of driving the minimum reference input resistance of 5 k Ω .

The internal 2.5V bandgap reference in the ADC10831/2/4/8 is available as an output on the V_{REF}^{Out} pin. To ensure optimum performance this output needs to be bypassed to ground with 100 μ F aluminum electrolytic or tantalum capacitor. The reference output can be unstable with capacitive loads greater than 100 pF and less than 100 μ F. Any capacitive loading less than 100 pF and greater than 100 μ F will not cause oscillation. Lower

output noise can be obtained by increasing the output capacitance. A 100 μ F capacitor will yield a typical noise floor of 200 nV/ $\sqrt{\text{Hz}}$. The pseudo-differential and differential multiplexer modes allow for more flexibility in the analog input voltage range since the "zero" reference voltage is set by the actual voltage applied to the assigned negative input pin.

In a ratiometric system (Figure 13a), the analog input voltage is proportional to the voltage used for the A/D reference. This voltage may also be the system power supply, so V_{REF}^+ can also be tied to AV^+ . This technique relaxes the stability requirements of the system reference as the analog input and A/D reference move together maintaining the same output code for a given input condition.

For absolute accuracy (Figure 13b), where the analog input varies between very specific voltage limits, the reference pin can be biased with a time- and temperature-stable voltage source that has excellent initial accuracy. The LM4040, LM4041 and LM185 references are suitable for use with the ADC10831/2/4/8.

The minimum value of V_{REF} ($V_{REF} = V_{REF}^+ - V_{REF}^-$) can be quite small (see Typical Performance Characteristics) to allow direct conversion of transducer outputs providing less than a 5V output span. Particular care must be taken with regard to noise pickup, circuit layout and system error voltage sources when operating with a reduced span due to the increased sensitivity of the converter (1 LSB equals $V_{REF}/1024$).

3.3 The Analog Inputs

Due to the sampling nature of the analog inputs, at the clock edges short duration spikes of current will be seen on the selected assigned negative input. Input bypass capacitors should not be used if the source resistance is greater than 1 k Ω since they will average the AC current and cause an effective DC current to flow through the analog input source resistance. An op amp RC active lowpass filter can provide both impedance buffering and noise filtering should a high impedance signal source be required. Bypass capacitors may be used when the source impedance is very low without any degradation in performance.

In a true differential input stage, a signal that is common to both "+" and "-" inputs is canceled. For the ADC10831/2/4/8, the positive input of a selected channel pair is only sampled once before the start of a conversion during the acquisition time (t_A). The negative input needs to be stable during the complete conversion sequence because it is sampled before each decision in the SAR sequence. Therefore, any AC common-mode signal present on the analog inputs will not be completely canceled and will cause some conversion errors. For a sinusoid common-mode signal this error is:

$$V_{\text{ERROR}}(\text{max}) = V_{\text{PEAK}} (2 \pi f_{\text{CM}}) (t_C)$$

where f_{CM} is the frequency of the common-mode signal, V_{PEAK} is its peak voltage value, and t_C is the A/D's conversion time ($t_C = 12/f_{\text{CLK}}$). For example, for a 60 Hz common-mode signal to generate a $1/4$ LSB error (0.61 mV) with a 4.8 μ s conversion time, its peak value would have to be approximately 337 mV.

Applications Hints (Continued)

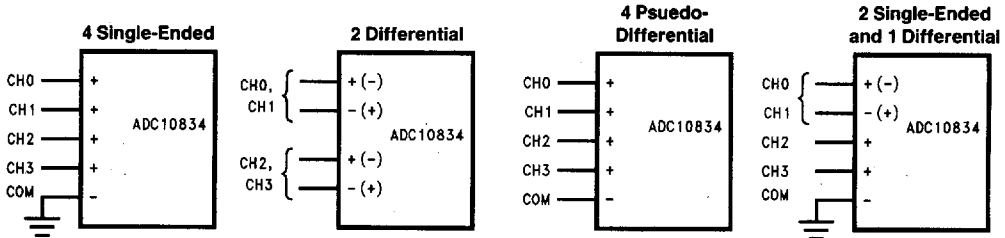
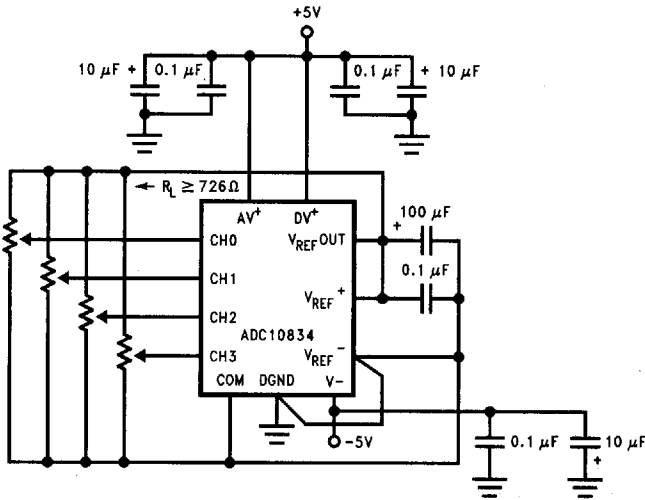

FIGURE 12. Analog Input Multiplexer Options

TL/H/11391-26

a. Ratiometric Using the Internal Reference



TL/H/11391-27

b. Absolute Using a ±4.096V Span

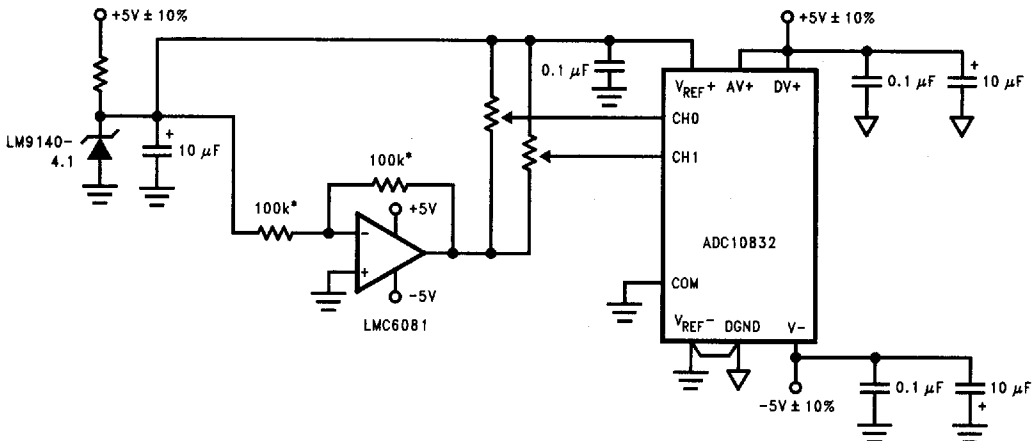

*0.1% Resistors

TL/H/11391-28

FIGURE 13. Different Reference Configurations

Applications Hints (Continued)

3.4 Optional Adjustments

3.4.1 Zero Error

The zero error of the A/D converter relates to the location of the first riser of the transfer function (see *Figure 1*) and can be measured by grounding the minus input and applying a small magnitude voltage to the plus input. Zero error is the difference between actual DC input voltage which is necessary to just cause an output digital code transition from 000 0000 0000 to 000 0000 0001 and the ideal $\frac{1}{2}$ LSB value ($\frac{1}{2}$ LSB = 2.0 mV for $V_{REF} = + 4.096V$).

The zero error of the A/D does not require adjustment. If the minimum analog input voltage value, $V_{IN(Min)}$, is not ground, the effective "zero" voltage can be adjusted to a convenient value. The converter can be made to output an all zeros digital code for this minimum input voltage by biasing any minus input to $V_{IN(Min)}$. This is useful for either the differential or pseudo-differential input channel configurations.

3.4.2 Full-Scale

The full-scale adjustment can be made by applying a differential input voltage which is $\frac{1}{2}$ LSB down from the desired analog full-scale voltage range and then adjusting the V_{REF} voltage ($V_{REF} = V_{REF+} - V_{REF-}$) for a digital output code changing from 011 1111 1110 to 011 1111 1111. In bipolar signed operation this only adjusts the positive full scale error.

3.4.3 Adjusting for an Arbitrary Analog Input Voltage Range

If the analog zero voltage of the A/D is shifted away from ground (for example, to accommodate an analog input signal which does not go to ground), this new zero reference should be properly adjusted first. A plus input voltage which equals this desired zero reference plus $\frac{1}{2}$ LSB is applied to selected plus input and the zero reference voltage at the corresponding minus input should then be adjusted to just obtain the 000 0000 0000 to 000 0000 0001 code transition.

The full-scale adjustment should be made [with the proper minus input voltage applied] by forcing a voltage to the plus input which is given by:

$$V_{IN(+)} f_s \text{ adj} = V_{MAX} - 1.5 \left[\frac{(V_{MAX} - V_{MIN})}{2^n} \right]$$

where V_{MAX} equals the high end of the analog input range, V_{MIN} equals the low end (the offset zero) of the analog range. Both V_{MAX} and V_{MIN} are ground referred. The V_{REF} ($V_{REF} = V_{REF+} - V_{REF-}$) voltage is then adjusted to provide a code change from 011 1111 1110 to 011 1111 1111. Note, when using a pseudo-differential or differential multiplexer mode where V_{REF+} and V_{REF-} are placed within the V^+ and GND range, the individual values of V_{REF+} and V_{REF-} do not matter, only the difference sets the analog input voltage span. This completes the adjustment procedure.

3.5 The Input Sample and Hold

The ADC10831/2/4/8's sample/hold capacitor is implemented in the capacitor array. After the channel address is loaded, the array is switched to sample the selected positive analog input. The sampling period for the assigned positive input is maintained for the duration of the acquisition time (t_A) 4.5 clock cycles.

This acquisition window of 4.5 clock cycles is available to allow the voltage on the capacitor array to settle to the positive analog input voltage. Any change in the analog voltage on a selected positive input before or after the acquisition window will not effect the A/D conversion result.

In the simplest case, the array's acquisition time is determined by the R_{ON} (3 k Ω) of the multiplexer switches, the stray input capacitance C_{S1} (3.5 pF) and the total array (C_L) and stray (C_{S2}) capacitance (48 pF). For a large source resistance the analog input can be modeled as an RC network as shown in *Figure 14*. The values shown yield an acquisition time of about 1.1 μ s for 10-bit unipolar or 10-bit plus sign accuracy with a zero-to-full-scale change in the input voltage. External source resistance and capacitance will lengthen the acquisition time and should be accounted for. Slowing the clock will lengthen the acquisition time, thereby allowing a larger external source resistance.

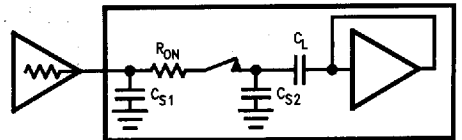

TL/H/11391-29

FIGURE 14. Analog Input Model

The signal-to-noise ratio of an ideal A/D is the ratio of the RMS value of the full scale input signal amplitude to the value of the total error amplitude (including noise) caused by the transfer function of the ideal A/D. An ideal 10-bit plus sign A/D converter with a total unadjusted error of 0 LSB would have a signal-to-(noise + distortion) ratio of about 68 dB, which can be derived from the equation:

$$S/(N + D) = 6.02(n) + 1.8$$

where $S/(N + D)$ is in dB and n is the number of bits.

Applications Hints (Continued)

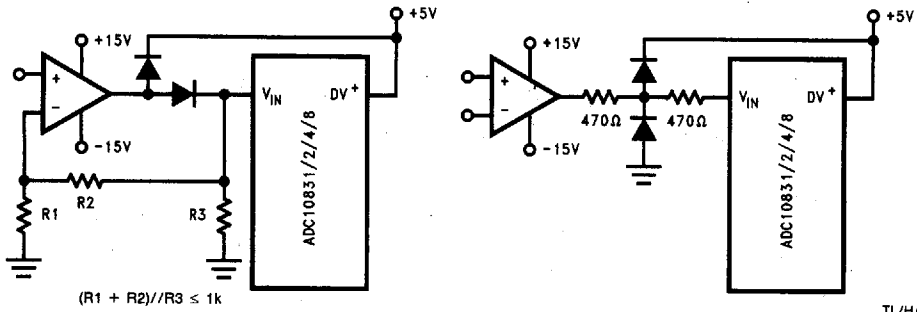

TL/H/11391-30

Note 1: Diodes are 1N914.

Note 2: The protection diodes should be able to withstand the output current of the op amp under current limit.

FIGURE 15. Protecting the Analog Inputs