

# Ø1.58 (.062") Female Housing

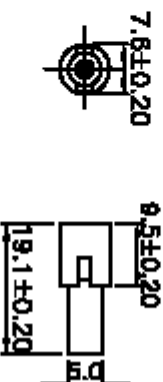

YY-3700-H01F1

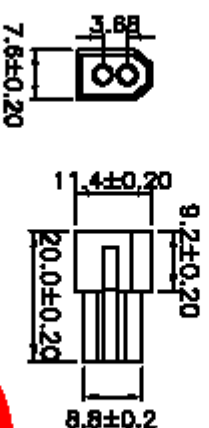

YY-3700-H02F1

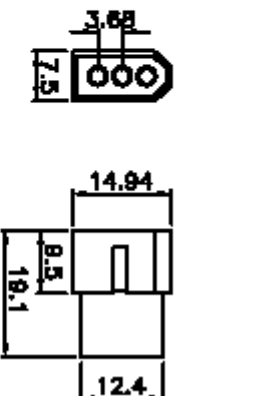

YY-3700-H03F1

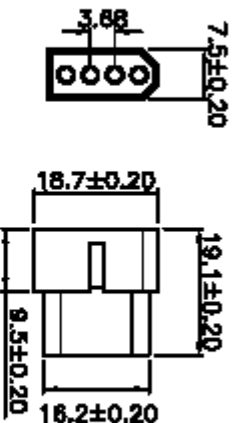

YY-3700-H04F1



### Features:

- Available in 01 through 15 Circuits
- Material: Nylon 66 UL94V-2
- Accepts YY-3700-TM crimp terminal
- Matches with YY-3700-HM

### Specifications:

- Pitch between poles 3.68mm
- Rated Voltage 250V AC, DC
- Rated Current 6A
- Withstand Voltage 1,500V AC/minute
- Insulation Resistance 1,000M Ohm/Min
- Temperature Range -25°C~+85°C

### Ordering Information:

YY-3700-HXXFX1X

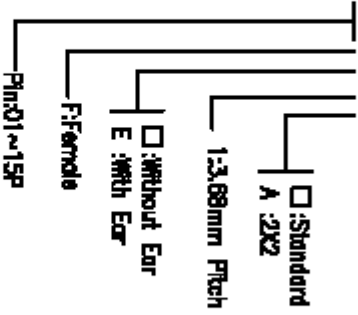

EDITION	DATE	MODIFY	VIEW	毅輝實業股份有限公司 YOUNG YAK ENTERPRISE CO.,LTD. TEL:886-2-2989-9629 FAX:886-2-2989-0575	DRAW BY	AUDITING	APPROVAL	DATE	DWG NO	TOLERANCE
AD	2004.08.04	DRAWING			Chao	JEF	Jeanfon	2004.08.04	YY-3700-HXXFX1X	.0 ±0.30 ±0.30

# Ø1.58 (.062") Female Housing

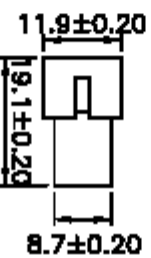
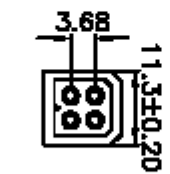

YY-3700-H04F1A

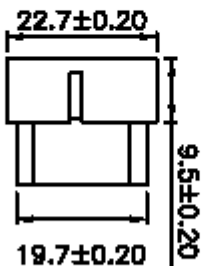
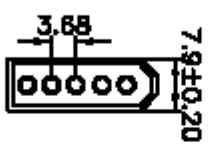

YY-3700-H05F1

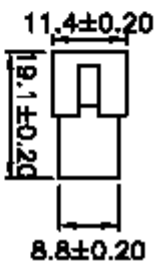
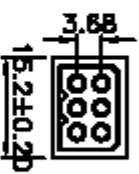

YY-3700-H08F1

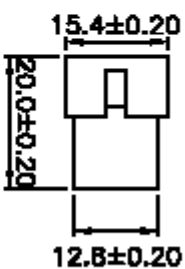
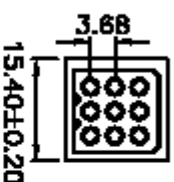

YY-3700-H09F1

## Features:

- Available in 01 through 15 Circuits
- Material: Nylon 66 UL94V-2
- Accepts YY-3700-TM crimp terminal
- Works with YY-3700-IM

## Specifications:

- Pitch between poles 3.68mm
- Rated Voltage 250V AC,DC
- Rated Current 6A
- Withstand Voltage 1,500V AC/minute
- Insulation Resistance 1,000M Ohm/Min
- Temperature Range -25°C~+85°C

## Ordering Information:

YY-3700-HXXFX1X

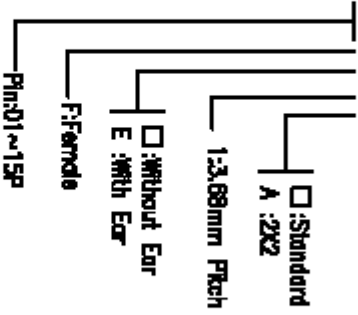

EDITION	DATE	MODIFY	VIEW	<p>YOUNG YAK ENTERPRISE CO.,LTD. TEL:886-2-2989-9629 FAX:886-2-2989-0575</p>	DRAW BY	AUDITING	APPROVAL	DATE	DWG NO	TOLERANCE
A0	2004.08.04	DRAWING			Chao	JTF	Jesoon	2004.08.04	YY-3700-HXXFX1X	.0 ±0.30 ±0.50

# Ø1.58 (.062") Female Housing

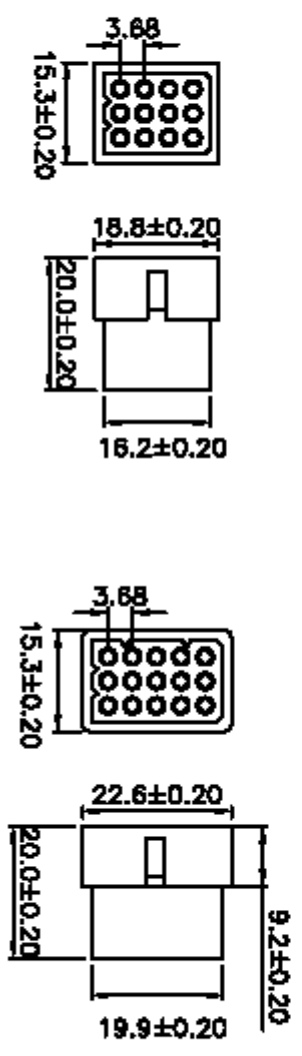

YY-3700-H12F1

YY-3700-H15F1

- Features:**
- Available in 01 through 15 Circuits
  - Material: Nylon 66 UL94V-2
  - Accepts YY-3700-TM crimp terminal
  - Matches with YY-3700-HM

- Specifications:**
- Pitch between poles 3.68mm
  - Rated Voltage 250V AC,DC
  - Rated Current 6A
  - Withstand Voltage 1,500V AC/minute
  - Insulation Resistance 1,000M Ohm/Min
  - Temperature Range -25°C~+85°C

## Ordering Information:

YY-3700-HXXFX1X

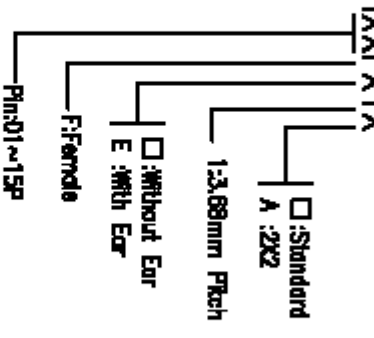

EDITION	DATE	MODIFY	VIEW	<p>YOUNG YAK ENTERPRISE CO.,LTD. TEL:886-2-2989-9629 FAX:886-2-2989-0575</p>	DRAW BY	AUDITING	APPROVAL	DATE	DWG NO	TOLERANCE
AD	2004.08.04	DRAWING			Chao	JEF	Jeaon	2004.08.04	YY-3700-HXXFX1X	C15810F1 131-3-AD

RoHS compliant

# Ø1.58 (.062") Male Housing

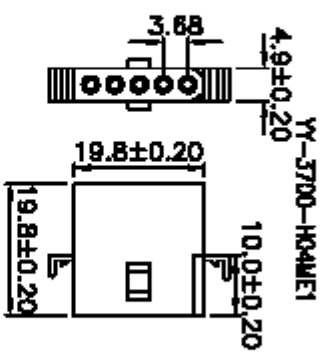
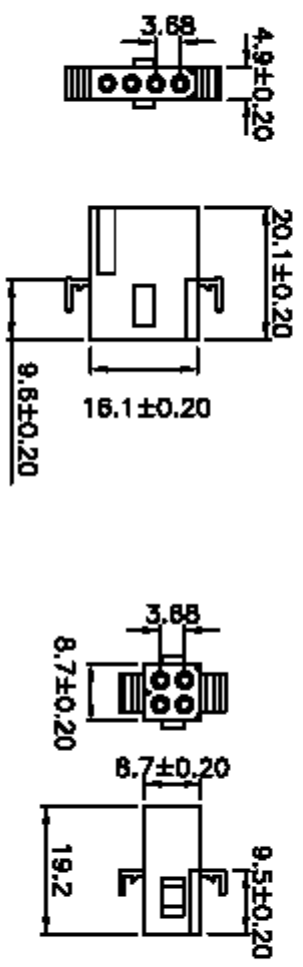
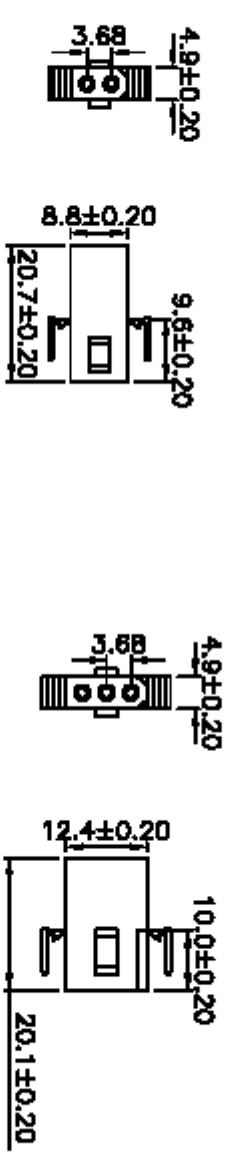

### Features:

- Available in 02 through 15 Circuits
- Material: Nylon 66 UL94V-2
- Accepts YY-3700-TM crimp terminal
- Matches with YY-3700-PMET

### Specifications:

- Pitch between poles 3.81mm
- Rated Voltage 250V AC,DC
- Rated Current 6A
- Withstand Voltage 1,500V AC/minute
- Insulation Resistance 1,000M Ohms/Ain
- Temperature Range -25°C~+85°C



### Ordering Information:

YY-3700-HXXME1X

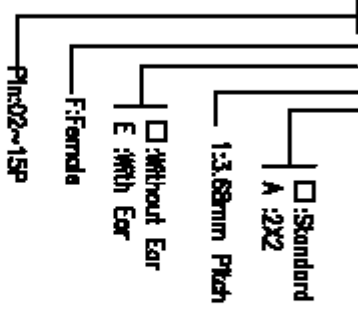

EDITION	DATE	MODIFY	VIEW			毅輝實業股份有限公司 YOUNG YAK ENTERPRISE CO.,LTD. TEL:886-2-2989-9629 FAX:886-2-2989-0575	DRAW BY	AUDITING	APPROVAL	DATE	DWG NO	DISEGNER	TOLERANCE
A0	2004.08.04	DRAWING					Chao	JET	Jeaon	2004.08.04	YY-3700-HXXME1X	131-1-A0	.0
												.00	±0.30

YY-3700-HQ5ME1

YY-3700-HQ2ME1

YY-3700-HQ3ME1

YY-3700-HQ4ME1A



# Ø1.58 (.062") Male Housing

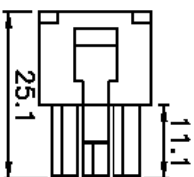
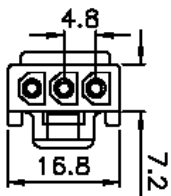
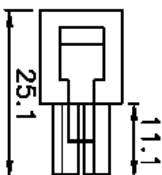
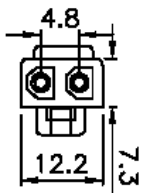

YY-3700-H02M2

YY-3700-H03M2

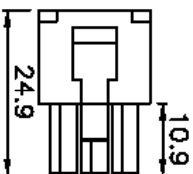
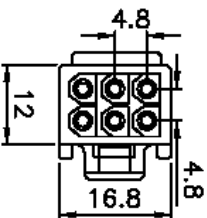
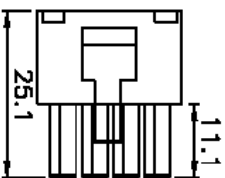
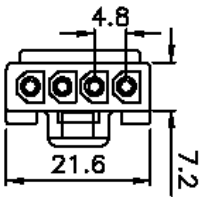

YY-3700-H04M2

YY-3700-H06M2

## Features:

- \* Available in 02 through 15 Circuits
- \* Material: Nylon 66 UL94V-2
- \* Accepts YY-3700-TF crimp terminal
- \* Mates with YY-3700-HF2

## Specifications:

- \* Pitch between poles 4.8mm
- \* Rated Voltage 250V AC,DC
- \* Rated Current 6A
- \* Withstand Voltage 1,500V AC/minute
- \* Insulation Resistance 1,000M Ohms/Min
- \* Temperature Range -25°C~+85°C



## Ordering Information:

YY-3700-HXXM2



EDITION	DATE	MODIFY	VIEW	 毅耀實業股份有限公司 YOUNG YAK ENTERPRISE CO.,LTD. TEL:886-2-2999-9629 FAX:886-2-2999-0575	DRAW BY	AUDITING	APPROVAL	DATE	DWG NO	TOLERANCE
AO	2004.08.04	DRAWING			Chao	JEFF	Jessica	2004.08.04	YY-3700-HXXM2	.0 ±0.30 ±0.30



# Ø1.58 (.062") Male Housing

## Features:

- Available in 01 through 15 Circuits
- Material: Nylon 66 UL94V-2
- Accepts YY-3700-TF crimp terminal
- Mates with YY-3700-4F

## Specifications:

- Pitch between poles 3.68mm
- Rated Voltage 250V AC/DC
- Rated Current 6A
- Withstand Voltage 1,500V AC/minute
- Insulation Resistance 1,000M Ohms/Min
- Temperature Range -25°C~+85°C



YY-3700-H01M1

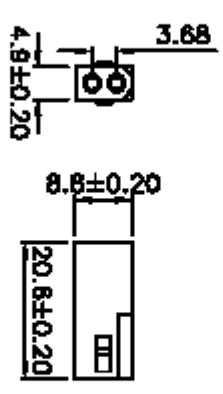

YY-3700-H02M1

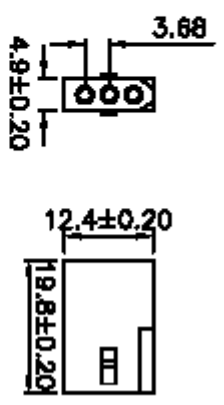

YY-3700-H03M1

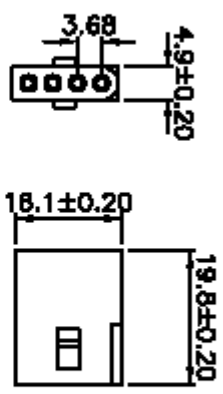

YY-3700-H04M1

## Ordering Information:

YY-3700-HXXMX1X

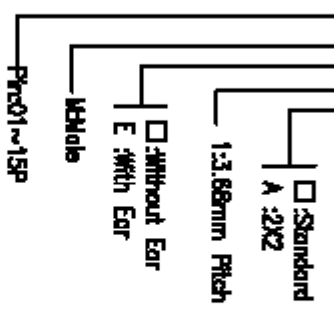

EDITION	DATE	MODIFY	VIEW		毅輝實業股份有限公司 YOUNG YAK ENTERPRISE CO.,LTD. TEL:886-2-2999-9629 FAX:886-2-2999-0575	DRAW BY	AUDITING	APPROVAL	DATE	DWG NO	TOLERANCE
A0	2004.08.04	DRAWING				Chao	JEFF	Jesson	2004.08.04	YY-3700-HXXMX1X	C15B0M1 131-1-A0

# Ø1.58 (.062") Male Housing

## Features:

- Available in 01 through 15 Circuits
- Material: Nylon 66 UL94V-2
- Accepts YY-3700-TF crimp terminal
- Mates with YY-3700-1F

## Specifications:

- Pitch between poles 3.81mm
- Rated Voltage 250V AC,DC
- Rated Current 6A
- Withstand Voltage 1,500V AC/mbrate
- Insulation Resistance 1,000M Ohms/Min
- Temperature Range -25°C~+85°C

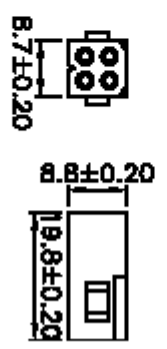

YY-3700-H04M1A

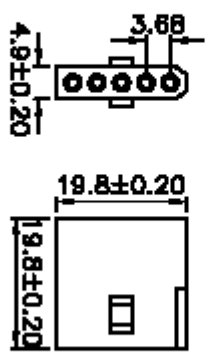

YY-3700-H05M1

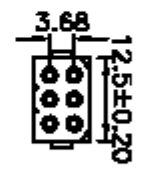

YY-3700-H08M1

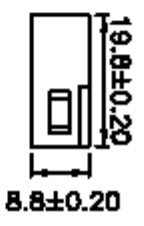

YY-3700-H09M1

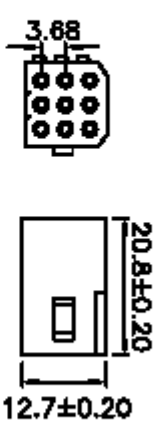

## Ordering Information:

YY-3700-HXXMX1X

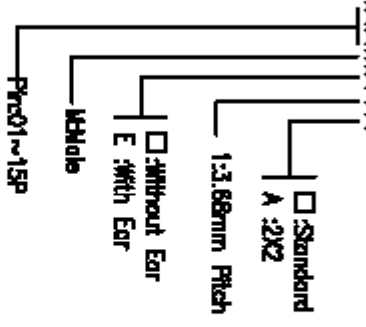

EDITION	DATE	MODIFY	VIEW	毅輝實業股份有限公司 YOUNG YAK ENTERPRISE CO.,LTD. TEL:886-2-2999-9629 FAX:886-2-2999-0575	DRAW BY	AUDITING	APPROVAL	DATE	DWG NO	TOLERANCE
A0	2004.08.04	DRAWING			Chao	JEFF	Jessica	2004.08.04	C15B01M1 131-2-A0	.0 ±0.30
								YY-3700-HXXMX1X	.00 ±0.30	







# Ø1.58 (.062") Female Housing

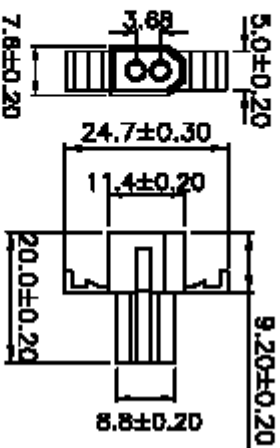

YY-3700-HQ2FE1

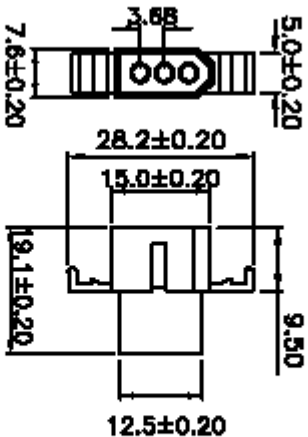

YY-3700-HQ3FE1

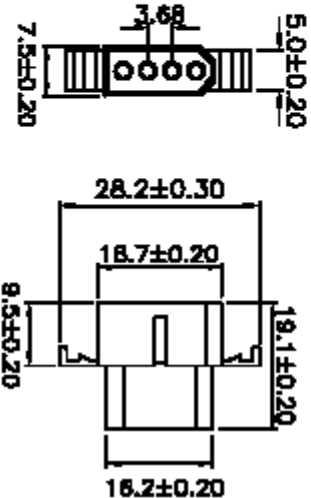

YY-3700-HQ4FE1

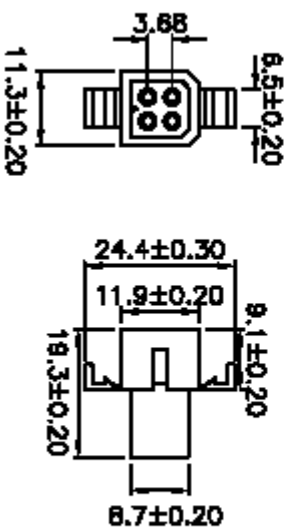

YY-3700-HQ4FE1A

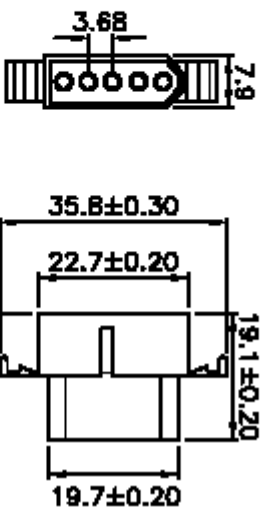

YY-3700-HQ5FE1

## Features:

- Available in 02 through 15 Circuits
- Material: Nylon 66 UL94V-2
- Accepts YY-3700-TF crimp terminal
- Mates with YY-3700-HF

## Specifications:

- Pitch between poles 4.81mm
- Rated Voltage 250V AC/DC
- Rated Current 6A
- Withstand Voltage 1,500V AC/minute
- Insulation Resistance 1,000M Ohms/Ain
- Temperature Range -25°C~+85°C

## Ordering Information:

YY-3700-HXXFE1X

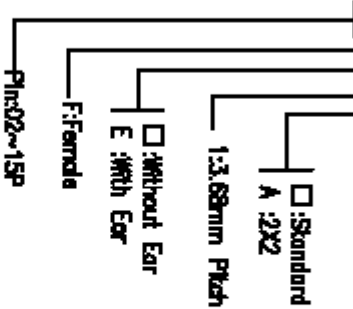

EDITION	DATE	MODIFY	VIEW	毅輝實業股份有限公司 YOUNG YAK ENTERPRISE CO.,LTD. TEL:886-2-2989-9629 FAX:886-2-2989-0575	DRAW BY	AUDITING	APPROVAL	DATE	DWG NO	TOLERANCE
A0	2004.08.04	DRAWING			Chao	JTF	Jeaon	2004.08.04	C1580FE1 131-1-A0	.0 ±0.30
								YY-3700-HXXFE1X		±0.30





# Ø1.58 (.062") Female Housing

## Features:

- \* Available in 02 through 15 Circuits
- \* Material: Nylon 66 UL94V-2
- \* Accepts YY-3700-TF crimp terminal
- \* Mates with YY-3700-HM2

## Specifications:

- \* Pitch between poles 4.80mm
- \* Rated Voltage 250V AC,DC
- \* Rated Current 6A
- \* Withstand Voltage 1,500V AC/minute
- \* Insulation Resistance 1,000M Ohms/Min
- \* Temperature Range -25°C~+85°C

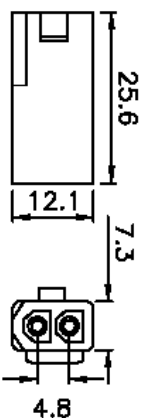

YY-3700-H02F2

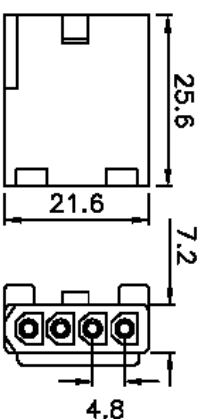

YY-3700-H04F2

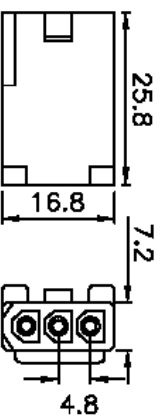

YY-3700-H03F2

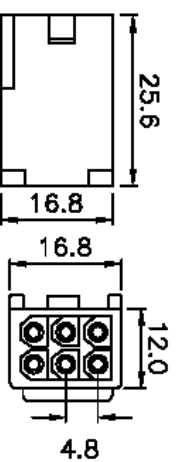

YY-3700-H06F2

## Ordering Information:

YY-3700-HXXFX2

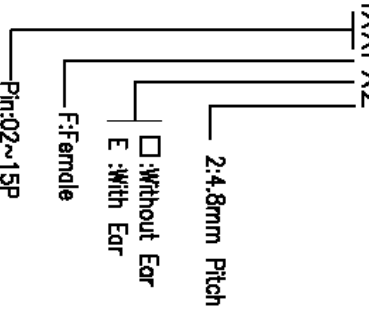

EDITION	DATE	MODIFY	VIEW	DRAW BY		AUDITING	APPROVAL	DATE	DWG NO	TOLERANCE	
A0	2004.08.04	DRAWING		Chao	JEFF	Jessica	2004.08.04	YY-3700-HXXFX2	C1580HF2 131-1-A0	.0	±0.30
										.00	±0.30



毅耀實業股份有限公司  
YOUNG YAK ENTERPRISE CO.,LTD.

TEL:886-2-2999-9629  
FAX:886-2-2999-0575

RoHS compliant

# Ø1.58 (.062") Female Housing

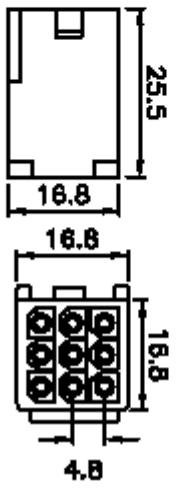

YY-3700-H08F2

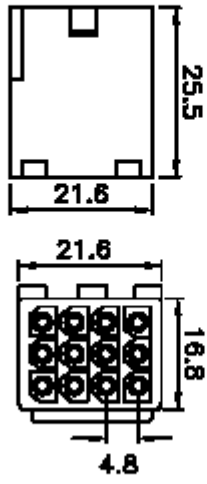

YY-3700-H12F2

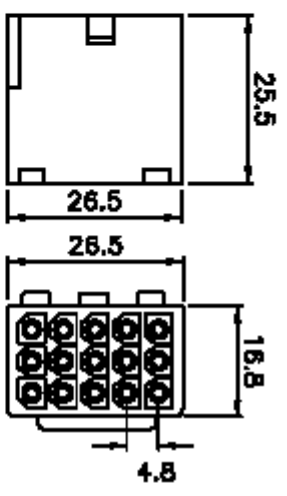

YY-3700-H15F2

### Features:

- Available in 02 through 15 Circuits
- Material: Nylon 66 UL94V-2
- Accepts YY-3700-TF crimp terminal
- Mates with YY-3700-MA2

### Specifications:

- Pitch between poles 4.8mm
- Rated Voltage 250V AC,DC
- Rated Current 5A
- Withstand Voltage 1,500V AC/minute
- Insulation Resistance 1,000M Ohms/Ain
- Temperature Range -25°C~+85°C

### Ordering Information:

YY-3700-HXXFX2

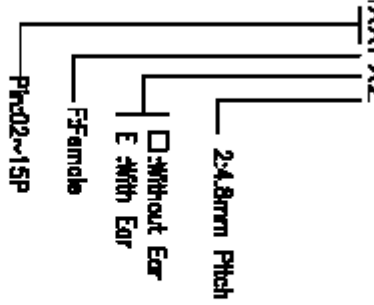

EDITION	DATE	MODIFY	VIEW	毅輝實業股份有限公司 YOUNG YAK ENTERPRISE CO.,LTD. TEL:886-2-2989-9629 FAX:886-2-2989-0575	DRAW BY	AUDITING	APPROVAL	DATE	DWG NO	TOLERANCE
AD	2004.08.04	DRAWING			Chao	JET	Jeanlon	2004.08.04	YY-3700-HXXF2	.0 ±0.30 ±0.30

# Ø1.58 (.062") Female Crimp Terminal

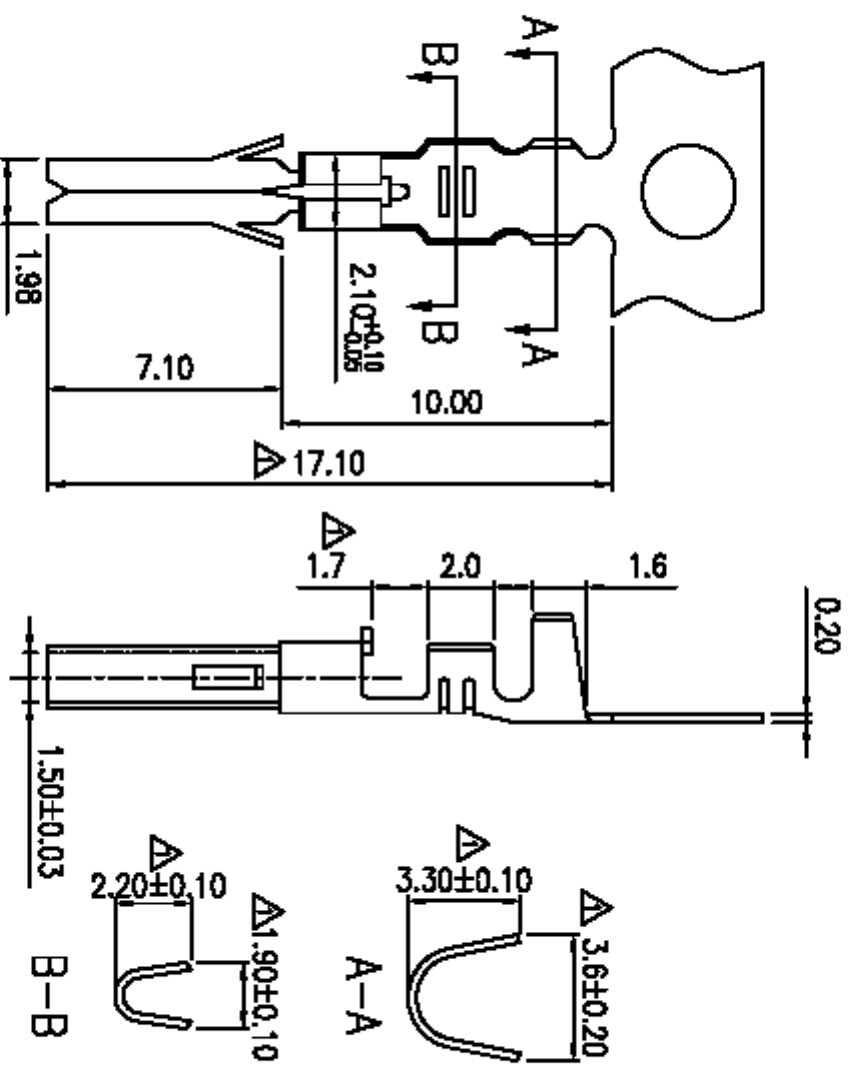

### Features:

- Used in YY-3700-1133M Series Housing
- Accepts AWG 18-24 Wire Range
- Insulation O.D. = 3.00 mm(max)
- Material : Phosphor bronze & Brass
- Finish : Tin-Plated
- Qty/Reel : 7,000 PCS
- Thickness: 0.20mm

### Specification:

- Pitch between poles 3.68mm±0.08mm
- Rated Voltage 250V AC,DC
- Rated Current 6A
- Withstand Voltage 1,500V AC/minute
- Insulation Resistance 1,000M Ohm/Min
- Temperature Range -25°C~+85°C

### Ordering Information:

YY-3700-TFXXX



EDITION	DATE	MODIFY	VIEW	DRAW BY	AUDITING	APPROVAL	DATE	DWG NO	C1580TF	TOLERANCE	
A0	2002.04.22	DRAWING		Chao	JEFF	Jesiod	2004.06.03	YY-3700-TFXXX	131-A1	.0	±0.30
A1	2004.06.03	DRAWING								.00	±0.30
										.000	

**YOUNG YAK ENTERPRISE CO., LTD.**  
 毅輝實業股份有限公司  
 TEL: 886-2-2998-9828  
 FAX: 886-2-2899-0575

