



Raychem

TE Internal #: 722909-000

Twisted Pair Cable, MIL-DTL-27500, 600VAC Voltage Rating,  
12AWG Wire Size, Operating Temperature Range -65 – 200 °C

[View on TE.com >](#)

Wire & Cable > Twisted Pair Cable



Cable Type: MIL-DTL-27500

Voltage Rating: 600 VAC

Insulation Material: Modified Radiation Cross-linked ETFE Polymer

Conductor Material: Silver-Coated Copper

Wire Size: 12 AWG

## Features

### Product Type Features

Cable Type	MIL-DTL-27500
------------	---------------

### Electrical Characteristics

Voltage Rating	600 VAC
----------------	---------

### Body Features

Insulation Material	Modified Radiation Cross-linked ETFE Polymer
Conductor Material	Silver-Coated Copper

### Dimensions

Wire Size	12 AWG
-----------	--------

### Usage Conditions

Operating Temperature Range	-65 – 200 °C[-85 – 392 °F]
-----------------------------	----------------------------

## Product Compliance

[For compliance documentation, visit the product page on TE.com>](#)

EU RoHS Directive 2011/65/EU	Compliant
EU ELV Directive 2000/53/EC	Compliant
China RoHS 2 Directive MIIT Order No 32, 2016	No Restricted Materials Above Threshold
EU REACH Regulation (EC) No. 1907/2006	



Current ECHA Candidate List: JUN 2020  
(209)  
Candidate List Declared Against: JUN 2015  
(163)  
Does not contain REACH SVHC

Halogen Content	Not Yet Reviewed for halogen content
Solder Process Capability	Not applicable for solder process capability

Product Compliance Disclaimer

This information is provided based on reasonable inquiry of our suppliers and represents our current actual knowledge based on the information they provided. This information is subject to change. The part numbers that TE has identified as EU RoHS compliant have a maximum concentration of 0.1% by weight in homogenous materials for lead, hexavalent chromium, mercury, PBB, PBDE, DBP, BBP, DEHP, DIBP, and 0.01% for cadmium, or qualify for an exemption to these limits as defined in the Annexes of Directive 2011/65/EU (RoHS2). Finished electrical and electronic equipment products will be CE marked as required by Directive 2011/65/EU. Components may not be CE marked. Additionally, the part numbers that TE has identified as EU ELV compliant have a maximum concentration of 0.1% by weight in homogenous materials for lead, hexavalent chromium, and mercury, and 0.01% for cadmium, or qualify for an exemption to these limits as defined in the Annexes of Directive 2000/53/EC (ELV). Regarding the REACH Regulations, TE's information on SVHC in articles for this part number is still based on the European Chemical Agency (ECHA) 'Guidance on requirements for substances in articles' (Version: 2, April 2011), applying the 0.1% weight on weight concentration threshold at the finished product level. TE is aware of the European Court of Justice ruling of September 10th, 2015 also known as O5A (Once An Article Always An Article) stating that, in case of 'complex object', the threshold for a SVHC must be applied to both the product as a whole and simultaneously to each of the articles forming part of its composition. TE has evaluated this ruling based on the new ECHA "Guidance on requirements for substances in articles" (June 2017, version 4.0) and will be updating its statements accordingly.

### Compatible Parts

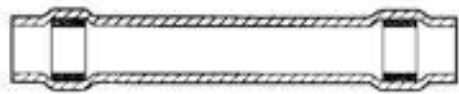

TE Model / Part # C60253-000  
D-200-84

### Customers Also Bought



TE Model / Part #228311-000  
HEX40-AC-00-21-A9-1-DS



TE Model / Part #A01393-000  
55PC0111-28-9

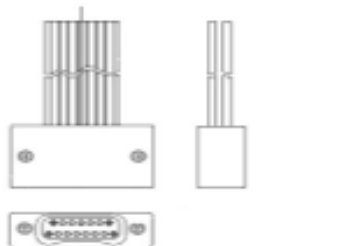

TE Model / Part #9-1589476-1  
STM015SC2DX010N = WDUALOBE



TE Model / Part #BTH1-15-08-1-ZN  
BTH1-15-08-1-ZN

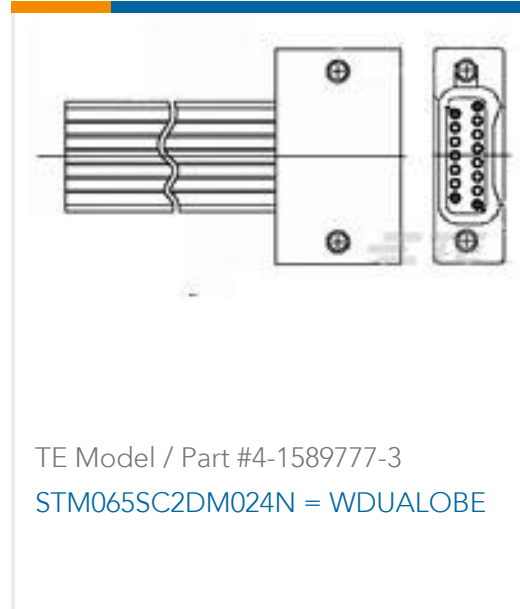
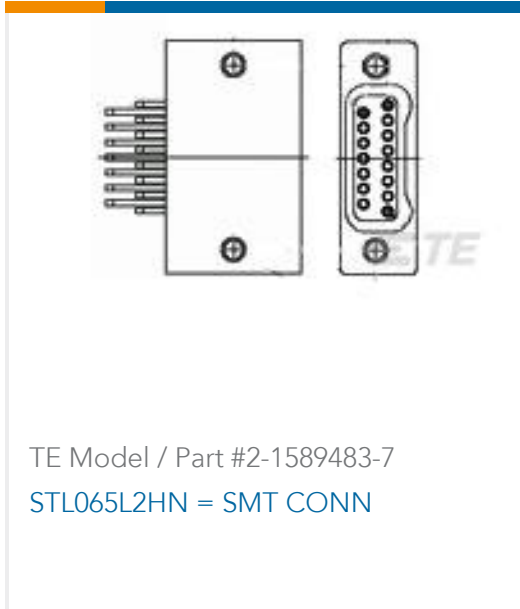
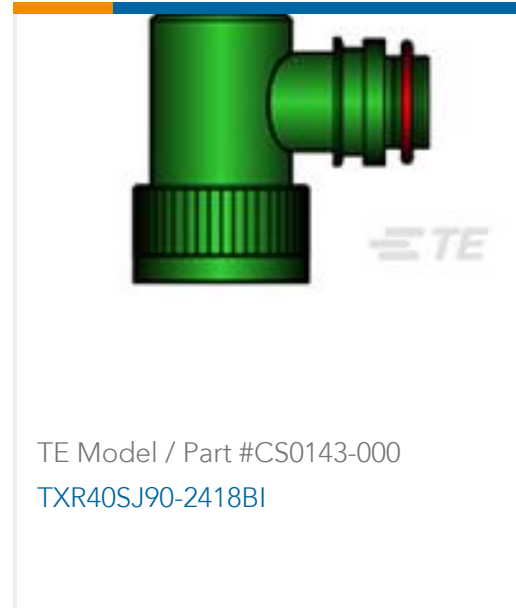
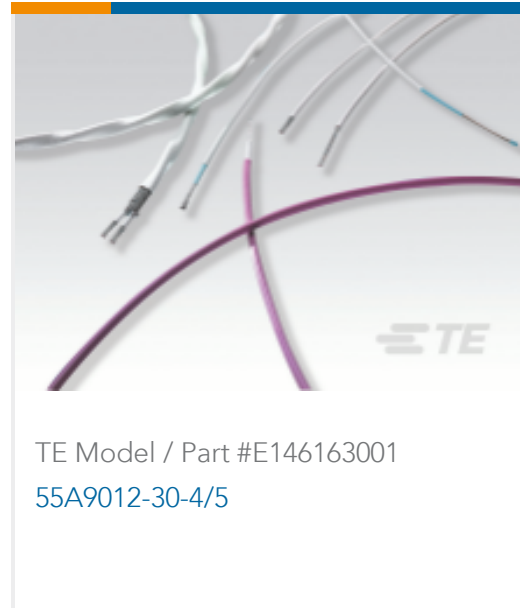

## Documents

### Product Drawings

[55A0832-12-9/93/96CS2275](#)

English

### Datasheets & Catalog Pages

[1654025\\_Sec9\\_SPEC55](#)

English

### Raychem Wire and Cable Quick Reference Guide

English

### Product Specifications

[Product Specification](#)

English